

1967
2023

MADE IN ITALY

Outdoor Catalogue

2023

 Italiano

 English

Sommario - Summary

Informazioni
IMPORTANTI
Very important
INFORMATION

Proiettori / Sospensioni - Floodlights



Pinguino serie
Pag. 6



Puma serie
Pag. 6



BASICseries - Virgola serie
Pag. 14



Tigre serie
Pag. 16



Extreme serie
Pag. 20

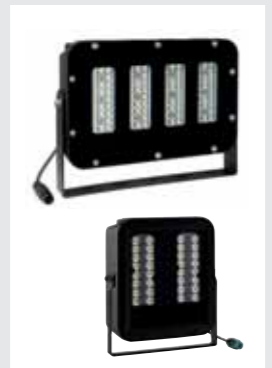

Jaguaro serie
Pag. 26



Torri Faro
Pag. 30



Minizeus - Zeus
Pag. 34



Zeus ATEX 2-22
Pag. 42

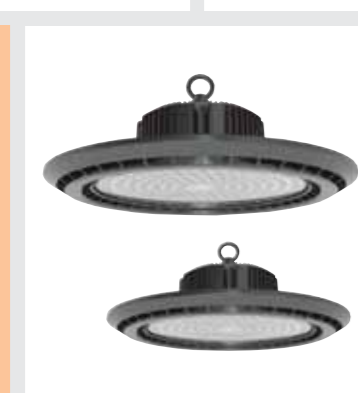

BASICseries - Punto serie
Pag. 44



AGP Evolution ATEX 2-22
Pag. 46

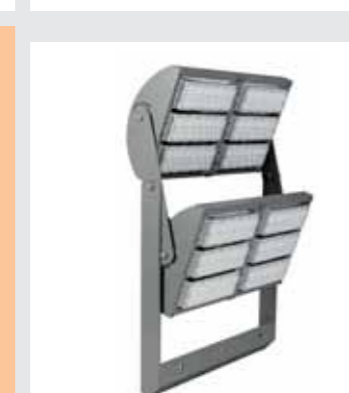

Lampo serie
Pag. 48



Tunnel serie
Pag. 56



Milano Sport
Pag. 59

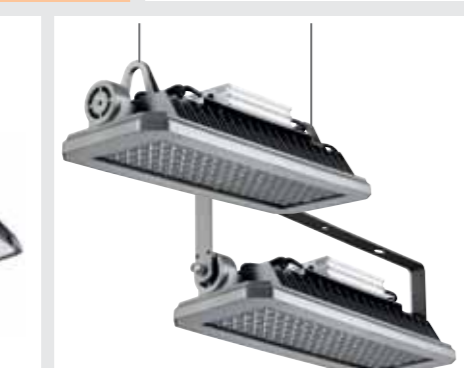

Milano Logistica
Pag. 66

Apparecchi stagni - Waterproof luminaires



Allegra Plus
Pag. 68



BASICseries Allegra Basic
Pag. 72



Gioia
Pag. 74



Felice
Pag. 76



Pupilla sensor DIM
Pag. 82



Allegra ATEX 2-22
Pag. 84



Allegra Metal
Pag. 86

Arredo urbano/Illuminazione stradale - Urban light/Street light



Lanterna NEW
Pag. 88



Lampione 2
Pag. 94



Lampione 4
Pag. 94



Lampione 6
Pag. 96



Lampione 8
Pag. 96



Lampione 10
Pag. 98



Lampione 12
Pag. 98



Gardena
Pag. 100

Arredo urbano/Illuminazione stradale - Urban light/Street light



Sempione serie
Pag. 102

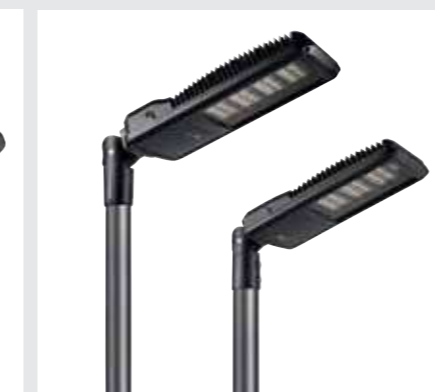

Spluga - Maxispuga
Pag. 110



Gran Sasso serie
Pag. 114



Monza Round
Pag. 120



Tuba Lux
Pag. 122

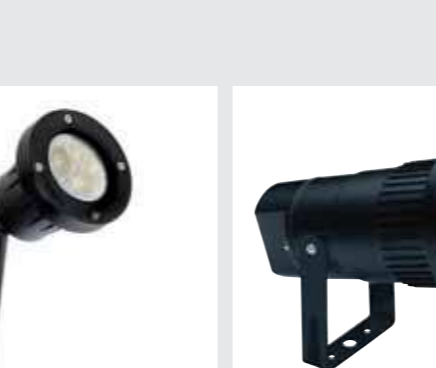

Positano
Pag. 123



Gargano
Pag. 124



Capri mini - Capri
Pag. 126



Ischia serie
Pag. 128



Nord
Pag. 134



Ovest
Pag. 136



Cubo
Pag. 137



Sud
Pag. 138



Maga serie
Pag. 140



Asso Round
Pag. 144



Asso Square
Pag. 146

Apparecchi per esterni residenziali - Outdoor luminaires



Su & Giu
Pag. 148



Doppio Su & Giu
Pag. 148



Micro Solo Giu Round
Pag. 150



Medio Solo Giu Square
Pag. 150



Sologiu R - Sologiu S
Pag. 152



Mole
Pag. 153



Up & Down
Pag. 154



Lodi Solo Giu
Pag. 156



Turbot
Pag. 158



Line Up
Pag. 159



Platax serie
Pag. 160



Platax E27 serie
Pag. 164



Luna Plena
Pag. 166

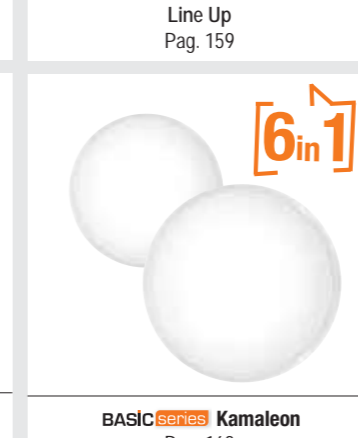

BASICseries Kamaleon
Pag. 168



Aster
Pag. 170



Plafoniere - Ceiling luminaires
Pag. 171

Apparecchi per esterni residenziali - Outdoor luminaires



Monza Round
Pag. 120



Tuba Lux
Pag. 122



Positano
Pag. 123



Gargano
Pag. 124



Capri mini - Capri
Pag. 126



Ischia serie
Pag. 128

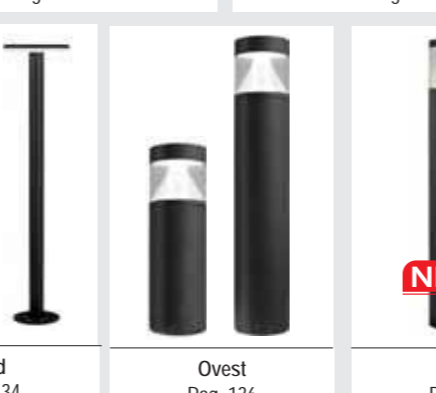

Nord
Pag. 134



Ovest
Pag. 136



Cubo
Pag. 137



Sud
Pag. 138



Maga serie
Pag. 140



Asso Round
Pag. 144



Asso Square
Pag. 146

Incassi - Recessed



Londra - Miami - Parigi
Pag. 176



Nasca
Pag. 180



Venezia
Pag. 182



Firenze
Pag. 184



Radiante
Pag. 186



Radante
Pag. 188



Monocilindrico
Pag. 190



Rondo
Pag. 192



Naasby R - Naasby Q
Pag. 194

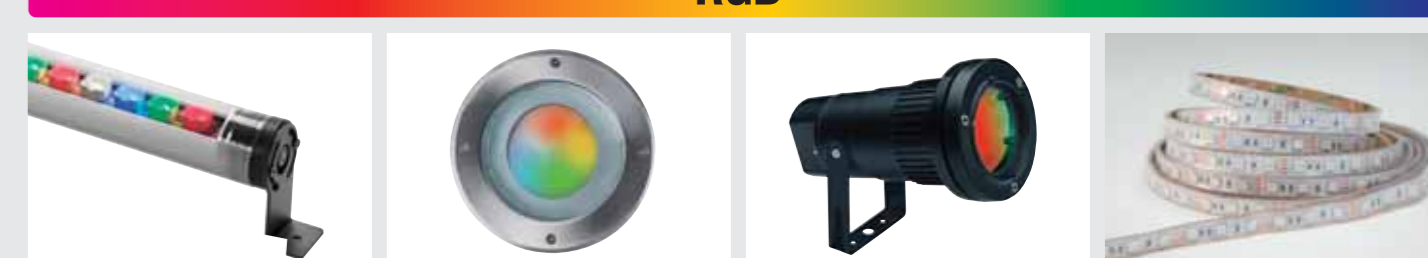

Monza Round Wall Washer RGB
Pag. 198

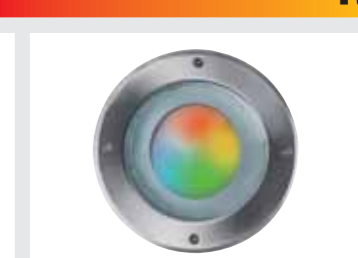

Rondo RGB
Pag. 200



Gargano RGB
Pag. 202



Strip Led RGB
Pag. 204



Lampo RGB
Pag. 206

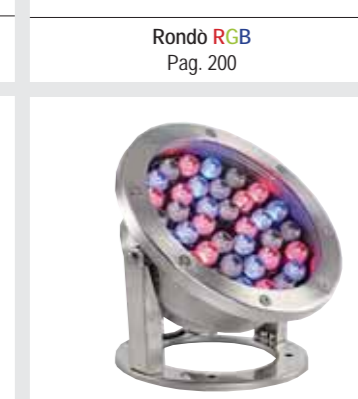

Lince RGB
Pag. 208



Accessori RGB - Accessories RGB
Pag. 211



Controllo dell'abbagliamento

L'illuminazione degli spazi operativi in un'ottica smart, deve essere in grado di migliorare il senso di benessere di chi lavora seguendo le necessità degli utenti finali.

I sistemi di regolazione di **RELCO** consentono di trovare il giusto equilibrio tra luce artificiale e luce naturale proveniente dall'esterno.

Ciò consente di dare sostegno al bioritmo umano e creare le migliori condizioni visive per ogni attività.

Un ambiente confortevole sotto il profilo illuminotecnico incoraggia la creatività delle persone che lo abitano.

Relco offre soluzioni illuminotecniche globali, in grado di offrire valore aggiunto all'unione tra luce e architettura.

Ampia scelta di apparecchi LED e sistemi di comando per le applicazioni più svariate dell'illuminazione professionale di: uffici e istituti didattici, negozi, hotel e wellness, salute e cura, arte e cultura, industria e tecnica.

Relco sa trovare il giusto equilibrio fra qualità della luce ed efficienza energetica sviluppando soluzioni illuminotecniche su misura.

Veniamo incontro alle vostre esigenze specifiche e alle necessità degli utenti, senza mai perdere di vista l'obiettivo di trovare la luce migliore per l'uomo e per l'ambiente.

Glare control

The lighting of the work areas from a smart perspective must be able to improve the well-being of those who work according to the needs of end users.

The RELCO regulation systems allow the right balance to be found between artificial light and natural light coming from outside.

This allows us to support human biorhythm and create the best visual conditions for any activity.

A comfortable environment in terms of lighting encourages the creativity of the people who live in it.

Relco offers global lighting solutions, able to offer added value to the combination of light and architecture.

A wide selection of LED fixtures and control systems for various professional lighting applications: offices and educational institutions, shops, hotels and wellness, health and care, art and culture, industry and engineering.

Relco knows how to find the right balance between quality of light and energy efficiency by developing customised lighting solutions.

We meet your specific needs and users' needs, without ever taking our eyes off the goal of finding the best light for humans and the environment.

UGR<... Classificazione valori UGR in funzione delle applicazioni. UGR value classification based on application.

UGR≤16	Applicazioni molto impegnative (disegni tecnici, lavoro a videoterminale). Highly demanding applications (technical drawings, working with video display terminals).
UGR≤19	Uffici e scuole (lettura, scrittura, riunioni). Offices and schools (reading, writing, meetings).
UGR≤22	Applicazioni industriali, artigianato. Industrial, artisanal applications.
UGR>28	Abbagliamento elevato. High glare.

Fattore di abbagliamento UGR<19

Valore contemplato secondo la norma
(coefficiente di riflessione: soffitto 0,7 - pareti 0,5).

Factor glare UGR<19

Value calculated according to the standard
(reflection coefficient: ceiling 0.7 - walls 0.5)

L'UGR è l'indicatore dell'abbagliamento diretto derivante dall'impianto di illuminazione.

La norma Europea per l'illuminazione dei posti di lavoro in interni **UNI-EN12464-1** richiede un valore UGR specifico per ogni applicazione, compreso tra 10 e 30. Più è basso il valore, minore è l'abbagliamento.

Il valore esatto di tale indice è da calcolare su progetto in quanto dipende dalla disposizione degli apparecchi illuminanti, dalle caratteristiche dell'ambiente (dimensioni, riflessioni) e dal punto di osservazione.

UGR is the indicator to assess the direct glare coming from a lighting system.

The UNI-EN12464-1 European standard for lighting indoor workplaces requires a specific UGR value for every application, ranging between 10 and 30. The lower the value, the lower the glare.

The exact value of this rating must be calculated in the design, as it depends on how the lighting fixtures are arranged, the features of the space (dimensions, reflections), and the viewpoint.

Prestazioni di alto livello - High level performances

Aspettativa di vita del LED e suo decadimento LED service life expectancy and deterioration

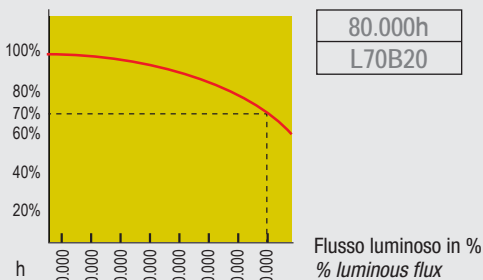

I LED diminuiscono gradualmente il loro flusso luminoso iniziale fino ad esaurirsi completamente in un periodo molto lungo. La durata di vita utile, indica la percentuale di decadimento del flusso luminoso (parametro "L") riferita ad un numero di ore utili di funzionamento. Il parametro "B" seguito da un valore normalmente compreso tra 10 e 50, indica la percentuale di componenti che, raggiunte le ore utili di funzionamento, non mantengono le caratteristiche di flusso luminoso dichiarate; ad esempio 80000h L70B20 vuol dire che l'80% dei moduli LED fornisce il 70% del flusso luminoso iniziale dopo 80000h di funzionamento.

The drop in LED flux is represented by acronym L70, which means flux at 70%. Value (B) followed by a value between 10 and 50 indicates the quality of the component being used, defining the percentage of LED that maintain the declared characteristics when the 80,000 hours have elapsed. Declared LED (L70B20) indicates that when 80,000 hours have elapsed, 80% (B20) of the LEDs have 70% of the flux they had at the beginning of their service life.

Pittogramma Low Flicker Low Flicker pictogram



Apparecchio con flicker molto basso
Product with a very low flicker

Flicker indica lo sfarfallio visibile a occhio nudo. Può verificarsi a frequenze inferiori a 60hz e dipende da diversi fattori tra cui il ripple di uscita degli alimentatori. E' importante definire "low" non vuol dire esente, ma ridotto.

Flicker is a common issue with LED lamps. It can occur at frequencies below 60 Hz and depends on several factors, such as the ripple emitted by drivers. Furthermore, "flicker-free" does not mean "without" but rather "very low".

RIPPLE FREE

Il **RIPPLE FREE** è un esempio dello sviluppo e ricerca sui prodotti Relco Lighting & Components. I driver LED Relco Lighting & Components sono forniti di un circuito multistadio per alimentare i LED con una corrente perfetta. Con il termine RIPPLE si fa riferimento alla dimensione della forma d'onda della corrente d'uscita del driver LED. Dove il ripple è presente la forma d'onda si deforma con conseguente surriscaldamento del LED che ne riduce la vita media. Inoltre il ripple, causa oscillazioni della luce provocando disturbi durante le riprese video. Sullo schermo verranno visualizzate una serie di righe scure in movimento verso il basso che renderanno l'immagine illeggibile. Quando si alimentano i LED con LED Driver RIPPLE FREE è possibile raggiungere le massime prestazioni ed efficienza luminosa, con la minima dissipazione di calore.

The **RIPPLE FREE** is an example of R&D on the Relco Lighting & Components products. The Relco Lighting & Components LED drivers are provided with multistage circuit to feed the LEDs with a perfect current. The term RIPPLE refers to the dimension of the wave form of the LED driver output current, when present this deforms the same wave form with consequent overheating of the LED with reduced average life. Also this phenomenon, cause of light oscillations, results in effects while shooting videos, where the images appear to be cut with several black lines making shooting impossible. When you feed the LEDs with Led driver RIPPLE FREE you can achieve maximum performance and light efficiency, with minimal heat dissipation.

Norme Europee di certificazione elettrica European norms electrical certification



Tutti i prodotti sono costruiti nel rispetto delle Normative Europee (2014/35/UE, 2006/95/CE, 2014/30/UE, 2004/108/CE, 2009/125/CE) come riportato nella dichiarazione di conformità UE.

All products are manufactured in compliance with European Directives (2014/35/UE, 2006/95/CE, 2014/30/UE, 2004/108/CE, 2009/125/CE) as reported in the UE conformity declaration.

Sicurezza fotobiologica Photobiological safety



La sicurezza fotobiologica è determinata dalla quantità di radiazioni emesse dalle sorgenti luminose con lunghezza d'onda compresa tra 200nm e 3000nm.

Un'esposizione eccessiva alle radiazioni, può essere causa di danni per l'uomo. La norma EN62471 definisce una classificazione delle sorgenti in gruppi di rischio. RG0 Ethr: apparecchi che non presentano rischio fotobio-logico ai fini della Norma EN62471. Richiedere in sede la distanza dal punto di osservazione, se necessaria.

RG0: assenza di rischi fotobiologici ai fini della norma EN62471.

RG1 (gruppo di rischio basso): la sorgente non provoca rischi dovuti a normali limitazioni di funzionamento sull'e-sposizione.

RG2 (gruppo di rischio moderato): la sorgente non pro-voca un rischio in seguito ad una reazione istintiva guar-dando fonti molto luminose o in seguito ad una sensazio-ne di disagio termico.

We often read about photo-biological safety in lighting design. This very important factor is determined by the amount of radiations emitted by all the sources with a wave length ranging between 200 nm and 3000 nm. Excessi-ve radiation exposure can be harmful for human health. The EN62471 standard classifies light sources into risk groups. Risk Group 0 (RG0 Ethr): luminaires are exempt from photobiological risks in compliance with standard EN 62471. If necessary, contact our customer service for the observation distance.

RG0 (exempt risk group): the lighting source is exempt from risks in compliance with EN 62471 Standard.

RG1 (low risk group): no risk deriving from a limited emission of radiation.

RG2 (moderate risk): the lighting source does not pose hazards because of our aversion response to very bright light sources, or due to the fact that we would experien-ce thermal discomfort.



ENEC è un Marchio Europeo di Certificazione di prestazione, è stato istituito in sede CENELEC (Comitato europeo di normazione elettrotecnica) dagli organismi di certificazione elettrica che hanno aderito ad un accordo denominato "LUM AGREEMENT" per il mutuo riconoscimento di un unico marchio "ENEC" equivalente ai singoli marchi degli organismi aderenti. ENEC è un marchio ad alto valore tecnico basato su severi criteri di certificazione che offre garanzie oltre che sulla sicurezza elettrica anche sulle prestazioni dell'apparecchio elettrico. A fianco del marchio ENEC viene posto un numero che identifica l'organismo che ha rilasciato la certificazione.

ENEC is a European Certification mark for performance established at CENELEC (European Committee for Electrotechnical Standardization) by electrical certification institutions. These bodies have entered an agreement called "LUM AGREEMENT" for the mutual recognition of a sole mark, "ENEC", equivalent to the single marks of the adhering institutions. ENEC is a high value technical mark based on strict certification criteria which offers a guarantee not only on electrical safety but also on the performance of the electrical apparatus.

Certificazioni ISO 9001 ISO 9001 certification



Cos'è la sovratensione? What is a surge?

È un rapido innalzamento del valore di tensione tra parti di diverse polarità e tra queste e la terra.

Alcune sovratensioni possono superare la soglia d'isolamento o di immunità dei componenti elettronici provocandone il disservizio.

A surge is a rapid increase in voltage on a power line between parts of opposite polarities and/or the ground. Some power surges may exceed the isolation or immunity threshold of electronic components causing it to fail.

Dispositivi di protezione Surge protector

Per fare fronte ai danni causati da sovracorrenti o sovratensioni viene utilizzato un dispositivo di protezione conforme alla norma EN 61547 contro i fenomeni impulsivi atto a proteggere il modulo LED e il relativo alimentatore.

To protect lighting installations from surge, i.e. the rapid increase in voltage between parts of opposite polarities and/or the ground, Relco Components & Lighting has equipped its luminaires with an EN 61547 compliant surge protector, capable of protecting the LED module and their related driver from voltage spikes, damages caused by lightning and overcurrents.

Modalità di protezione Protection modes

Modo differenziale: Surge tra i conduttori di alimentazione, tra il conduttore di sovratensione verso quello di neutro. Sostanzialmente, tra fase (L) e neutro (N) non si presentano sovratensioni molto elevate perché i picchi di tensione vengono soppressi da altre apparecchiature collegate alla rete elettrica; di conseguenza è sufficiente una protezione più bassa da sovratensione. A seconda della famiglia di prodotto, Relco Lighting & Components integra quindi una protezione fino a 6 kV.

Modo comune: Surge tra i conduttori di alimentazione, L/N, verso la terra o il corpo dell'apparecchio se quest'ultimo è in classe II (se questo è installato su palo metallico). Le sovratensioni di modo comune sono ad esempio generate dai fulmini, e possono raggiungere valori molto elevati. A seconda della famiglia di prodotto, Relco Components & Lighting integra una protezione fino a 8 kV (a richiesta 10kV).

Differential mode: Surge between power conductors, between the phase conductor to the neutral conductor. Substantially, between phase (L) and neutral (N) no substantial surges are present because voltage peaks are suppressed by other equipment connected to the power line; as a consequence a lower surge protector is sufficient. Depending on the type of product, Relco Lighting & Components provides a protection from surges of up to 6kV

Common mode: Surge between power conductors, L/N, to the ground or the body of the luminaire if it is classified in class II (i.e. it is installed on a metal pole). Overvoltage in the common mode are generated by lightning strikes and may reach very high levels. Depending on the type of product, Relco Lighting & Components provides a protection from surges of up to 8 kV (10kV upon request).

Gli effetti delle sovratensioni The effects of surges

Sovratensioni di ridotta entità non comportano necessariamente l'immediato guasto di moduli LED o driver (se pur con protezione 4kV), se però si verificano ripetutamente possono provocare il deterioramento precoce dei LED e, di conseguenza, una durata ridotta. Sovratensioni elevate (caduta dei fulmini) si traducono invece nel guasto immediato dei moduli LED o dei driver. Nei moduli LED e nei driver le sovratensioni provocano correnti elevate (impulsi di energia). Questo fenomeno può provocare:

- guasto parziale o totale dei moduli LED o dei driver
- deterioramento accelerato dei moduli LED diminuendone la durata
- possibile guasto anche dell'interfaccia di comando

Small overvoltages do not necessarily lead to the immediate failure of LED modules or drivers (albeit with 4kV protection), but if they occur repeatedly they can cause premature deterioration of the LEDs and, consequently, a shortened life span. High overvoltages (lightning strikes), on the other hand, result in immediate failure of the LED modules or drivers. In LED modules and drivers, overvoltages cause high currents (energy pulses). This phenomenon can cause:

- partial or total failure of the LED modules or drivers
- accelerated deterioration of the LED modules reducing their duration
- possible failure of the command interface as well



Riprese televisive con illuminazione a LED TV footage with LED lighting

Durante una trasmissione televisiva, si può notare un fastidioso sfarfallio delle immagini a rallentatore. Il fenomeno di "flicker", affatica la vista e distrae lo spettatore. Le cause dello sfarfallio possono essere: frequenza della modulazione, fluttuazione di tensione e numero di fotogrammi al secondo. Generalmente uno sfarfallio inferiore al 5% non da alcun fastidio durante le riprese fino a 150 fotogrammi al secondo. Un sistema di illuminazione con un fattore di sfarfallio (FF) inferiore a 5% è in grado di eliminare il disturbo percepito.

During a broadcast it is not uncommon to perceive an annoying flicker especially during slow motion. This flicker is distracting and should be eliminated where possible. The circumstances that produce the flicker vary upon the frequency modulation, voltage and camera frame rate. The table below provides a general rule of flicker factor values produced by various lighting systems. A flicker factor of less than 5% will generally not cause problems for slow motion replays at up to 150 frames per second. A lighting system with a flicker factor of less than 5% will eliminate the perceived flicker at most frame rates per second used within the sports television industry. The acceptable level of flicker factor (FF) is indicated in the Illuminance Category Tables.

Tabella dei valori Flicker Factor (FF)	
Tipo di illuminazione	Valore FF (indicativo)
Luce naturale	0%
Apparecchi LED. La % di sfarfallio dipende dal tipo di LED e alimentatore utilizzati	< 3%
Lampade a scarica con alimentatori ad alta intensità	< 4%
Lampade a scarica con alimentatori magnetici trifase in grado di emettere luce uniforme	8 - 20%
Lampade a scarica con alimentatori elettromagnetici monofase	30 - 50%

Flicker Factor reference table (FF)	
Lighting type	FF value (indicative)
Daylight	0%
LED Luminaires % of flicker depend upon the type of LED power supply	< 3%
Discharge lamps with high frequency ballasts	< 4%
Discharge lamps with 3-phase magnetic ballasts for uniform light	8 - 20%
Discharge lamps with single-phase magnetic ballasts	30 - 50%

Protezione IP - IP Protection

Schema relativo alle cifre che compongono il grado IP	
Significato relativo alla prima cifra del grado di protezione	
1	Protezione da oggetti solidi maggiori di 50mm
2	Protezione da oggetti solidi maggiori di 12mm
3	Protezione da oggetti solidi maggiori di 2,5mm
4	Protezione da oggetti solidi maggiori di 1mm
5	Protezione da polveri
6	Protezione forte da polveri
Significato relativo alla seconda cifra del grado di protezione	
1	Protezione da gocce d'acqua
2	Protezione da gocce d'acqua deviate fino a 15°
3	Protezione da vapori d'acqua
4	Protezione da spruzzi d'acqua
5	Protezione da getti d'acqua
6	Protezione da getti d'acqua forti o mareggiate
7	Protezione contro l'immersione
8	Protezione contro l'immersione continua
Questo semplice schema ci suggerisce quindi che qualsiasi prodotto di illuminazione dovrà essere scelto in base al suo grado di protezione IP. Tale grado sarà il risultato della valutazione delle caratteristiche del luogo di installazione del medesimo prodotto e del suo impiego.	

<i>Diagram of the numbers that make up the IP rating</i>	
Meaning of the first numbers of the protection rating	
1	Protection from solid objects larger than 50 mm
2	Protection from solid objects larger than 12 mm
3	Protection from solid objects larger than 2.5 mm
4	Protection from solid objects larger than 1 mm
5	Protection from dust
6	Strong protection from dust
Meaning of the second numbers of the protection rating	
1	Protection from dripping water
2	Protection from dripping water when tilted up to 15°
3	Protection from spraying water
4	Protection from splashing water
5	Protection from water jets
6	Protection from powerful water jets or sea storms
7	Protection from immersion
8	Protection from continuous immersion
<i>This simple diagram suggests that any lighting fixture must be chosen based on its IP rating. This rating will be the result of an assessment of the characteristics of the place of installation of the product itself and of its use.</i>	

Esempi di IP presenti su alcuni apparecchi per interni ed esterni	
IP44	Il grado IP 44 garantisce la protezione contro la penetrazione di corpi solidi maggiori di 1 mm. Permette la protezione contro la penetrazione di liquidi da gocce, vapori o spruzzi in qualsiasi direzione
IP54	Il grado IP54 garantisce la protezione totale alla penetrazione di corpi solidi, di liquidi da gocce, vapori o spruzzi in qualsiasi direzione. Questo grado di isolamento non permette la penetrazione di polveri e liquidi non deve danneggiare l'apparecchiatura
IP55	Il grado IP55 garantisce la protezione totale alla penetrazione di corpi solidi, la penetrazione di liquidi da gocce, vapori, spruzzi e getti d'acqua in qualsiasi direzione. Inoltre non deve permettere la penetrazione di polveri e liquidi non deve danneggiare l'apparecchiatura.
IP65	Il grado IP65 garantisce la protezione totale alla penetrazione di corpi solidi, la penetrazione di liquidi da gocce, vapori, spruzzi e getti d'acqua in qualsiasi direzione. In questo grado di protezione, la penetrazione liquidi non deve danneggiare l'apparecchiatura
IP66	Il grado IP66 è garanzia di protezione totale alla penetrazione di corpi solidi e polveri, di penetrazione di liquidi da spruzzi, mareggiate e forti getti d'acqua in qualsiasi direzione. Anche in questo caso la penetrazione liquidi non deve danneggiare l'apparecchiatura
IP67	Il grado IP67 garantisce la protezione totale alla penetrazione di corpi solidi e polveri, la protezione contro l'immersione in acqua momentanea per 30 minuti a 1 metro di profondità.
IP68	Il grado IP68 permette una protezione totale alla penetrazione di corpi solidi e polveri, contro l'immersione in acqua permanente a 1 metro di profondità.
IP68-xx	Il grado IP68-XX permette una protezione totale alla penetrazione di corpi solidi e polveri, contro l'immersione in acqua permanente a xx metri di profondità

Examples of IPs present on some indoor or outdoor lamp	
IP44	<i>The IP 44 rating ensures protection from penetrating solid bodies greater than 1 mm. It also ensures protection from dripping, spraying and splashing water in any direction</i>
IP54	<i>The IP 54 rating ensures complete protection from penetrating solid bodies as well as dripping, spraying and splashing water in any direction. This insulation rating ensures protection from dust ingress and penetrating liquids which must not damage the equipment.</i>
IP55	<i>The IP 55 rating ensures complete protection from penetrating solid bodies as well as from dripping, spraying, splashing water and water jets in any direction. Moreover, it must protect from dust ingress and penetrating liquids which must not damage the equipment</i>
IP65	<i>The IP 65 rating ensures complete protection from penetrating solid bodies as well as dripping, spraying, splashing water and water jets in any direction. With this insulation rating, penetrating liquids must not damage the equipment.</i>
IP66	<i>The IP 66 rating ensures complete protection from penetrating solid bodies and dust ingress, as well as from dripping, spraying, splashing water, sea storms and strong water jets in any direction. In this case as well, penetrating liquids must not damage the equipment</i>
IP67	<i>The IP67 rating ensures complete protection from penetrating solid bodies and dust ingress, and from temporary immersion in water for 30 minutes at a depth of 1 metre</i>
IP68	<i>The IP68 rating ensures complete protection from penetrating solid bodies and dust ingress, from permanent immersion in water at a depth of 1 metre</i>
IP68-xx	<i>The IP68-xx rating ensures complete protection from penetrating solid bodies and dust ingress, from permanent immersion in water at a depth of xx metres</i>

Sistemi di controllo Control systems

1-10Vdc

Controllo dell'illuminazione in modo facile, elegante ed energeticamente efficiente con un dimming continuo. Permette una riduzione dei costi dell'illuminazione e del consumo di energia. Per tutti i componenti necessari vi consigliamo di fare riferimento al catalogo Relco Components scaricabile dal sito.

Easy access mode for controlling the illumination, elegant and energy-efficient through a continuous dimming. It permits a sensible cost-reduction of the illumination energy-consume. For all required components, please refer to the Relco Components catalogue which can be downloaded from the website.



Digital Address Lighting Interface

La regolazione mediante l'interfaccia digitale DALI (Digital Addressable Lighting Interface) rappresenta l'evoluzione della regolazione analogica. Questa interfaccia è stata sviluppata comunemente dai più importanti produttori di alimentatori elettronici per realizzare uno standard di regolazione comune all'industria mondiale illuminotecnica.

Caratteristiche principali della REGOLAZIONE DALI

- Memorizzazione di scenari luminosi;
- Messaggi per lampada guasta o a fine vita;
- Nessun problema con le fasi della rete;
- Nessuna necessità di rispettare la polarità dei cavi di regolazione;
- Possibilità di assegnare un indirizzo univoco ad ogni dispositivo connesso.

Regulation by means of DALI (Digital Addressable Lighting Interface) digital interface represents an evolution in analogical regulation. This interface has been jointly developed by the most important producers of electronic drivers to create a standard regulation for the lighting engineering industry all over the world.

Main features of the DALI REGULATION

- Memory function of light scenes;
- Messages for breakdown or end of life of the lamp;
- No problem with the phases of the supply mains;
- No need to observe the polarity of the regulation cables;
- Possibility to assign a unique address to each connected device.



Sistema di controllo con l'utilizzo di pulsanti standard per la gestione della tensione di rete al fine di regolare il flusso luminoso. Con una breve pressione si potranno accendere, spegnere e regolare i driver collegati. Il funzionamento può essere effettuato da più punti. Soluzione integrabile con sensore di luce.

Control system with the use of standard buttons for managing the mains voltage in order to adjust the luminous flux. With a short press the connected drivers can be switched on, off and adjusted. Operation can be carried out from several points. Solution that can be integrated with light sensor.

Wireless



Sistema di controllo puntuale dell'impianto mediante tecnologia senza la necessità dell'installazione di cavi elettrici.

La gestione è possibile mediante telecomando e/o smartphone.

Thorough installation control system via technology not requiring electrical cables to be laid.

Management is possible via remote control and/or smartphone.



DMX

Protocollo per illuminazione dinamica.

Il tempo di reazione è immediato e il numero di apparecchi che si può controllare è praticamente illimitato. DMX può essere utilizzato anche per la dimmerazione delle luci di impianti sportivi.

DMX consente un'intera gamma di effetti scenici; il monitoraggio di ogni apparecchio di illuminazione e una configurazione facile da eseguire attraverso le funzioni DMX autoindirizzanti.

Dynamic lighting protocol.

The reaction time is immediate and the number of devices that can be controlled is practically unlimited. DMX can also be used for dimming the lights of sports facilities.

DMX allows a whole range of scenic effects; the monitoring of each luminaire and an easy configuration through the self-addressing DMX functions.



Sensori di luminosità/presenza

Consentono un utilizzo intelligente della luce di spazi altrimenti difficilmente gestibili, ottenendo così importanti risparmi di energia.











L'uso dei sensori è consigliato in ambienti in cui vi sia un'occupazione saltuaria o dove è necessario un livello di illuminamento costante.







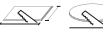

Brightness/presence sensor

They do permit a very flexible utilization of the light in difficulties spaces, handled by a stable concept of illumination.

In addition, they do permit the easy handling and control of the in line with the different needs, obtaining important energy saving.

Legenda simboli - Symbols legend













colour	Colore apparecchio - <i>Surface finish</i>
W	Watt
pcs	Quantità minima ordinabile - <i>Minimum quantity to be ordered</i>
Kg	Peso netto in Kg del prodotto - <i>Net product weight in Kg</i>
time/flux	Autonomia/flusso - <i>Duration/flux</i>
A	Ampere
Hz	Frequenza - <i>Frequency</i>
V	Volt
colour	Colore apparecchio - <i>Lamp colour</i>
time/flux	Autonomia/flusso - <i>Duration/flux</i>
Hz	Frequenza - <i>Frequency</i>
LED	Tipo di LED - <i>LED type</i>
S	Corpo apparecchio - <i>Body</i>
S + L	Corpo apparecchio + lampada - <i>Body + bulb</i>
CELL	Corpo apparecchio + alimentazione elettronica + scheda LED <i>Body + driver + circuit LED</i>
CELL-E	Corpo apparecchio + alimentazione elettronica + lampada + emergenza <i>Body + driver + Bulb + emergency kit</i>
	Rotazione dell'apparecchio sull'asse verticale e orizzontale <i>Rotation of the device on the vertical and horizontal axis</i>
	Dotato di vetro di protezione temperato <i>Equipped with tempered protection glass</i>
	Apparecchio costruito con materiali riciclabili <i>This device is made of recyclable materials</i>
	Apparecchio che resiste alla prova del filo incandescente <i>The device passes the glow wire test</i>
	Con isolamento funzionale in ogni parte e terminale o morsetto di terra se fisso <i>With functional isolation in each part and terminal or ground clamp if fixed</i>
	Con doppio isolamento, senza dispositivi per la messa a terra <i>With double insulation, without ground devices</i>
	Temperatura ambiente di funzionamento - <i>Operating ambient temperature</i>
	Indice di Resa Cromatica <i>Color Rendering Index</i>
	Apparecchi calpestabili e/o carrabili con bassa emissione di calore sul diffusore. <i>Walkover or/and drive over fitting with low heat emission on the diffuser</i>
	HIGH EFFICIENCY
	Prodotto dotato di kit d'emergenza <i>Article with emergency kit</i>
Lm/W	Efficienza lm/W apparecchio - <i>Efficiency lm/W unit</i>
nominal lm tc = 25°C	Efficienza della sorgente luminosa - <i>Efficiency of the light source</i>
lm output *	Efficienza luminosa effettiva dell'apparecchio <i>Effective luminous efficiency of the fixture</i>

	Prodotto con certificazione CB <i>Product with CB certificate</i>
	Prodotto conforme alle direttive D.M. 11 Ottobre 2017 <i>In compliance with the directives D.M. 11 Ottobre 2017</i>
	Dimensioni foro incasso <i>Hole for fitting dimensions</i>
	Resistenza dell'apparecchio alla penetrazione di liquidi o solidi <i>Devices resistance to the penetration of liquids or solids</i>
	Grado di resistenza agli urti <i>Impact resistance degree</i>
	LED COB full color
	LED SMD singol color
	Resistenza dell'apparecchio alla penetrazione di liquidi o solidi <i>Devices resistance to the penetration of liquids or solids</i>
	LED COB FULL COLOR
K	Temperatura di colore in Kelvin <i>Kelvin colour temperature</i>
3000K	Temperatura di colore in Kelvin - luce calda <i>Kelvin color temperature - warm white</i>
4000K	Temperatura di colore in Kelvin - luce neutra <i>Kelvin color temperature - day lights</i>
6000K	Temperatura di colore in Kelvin - luce fredda <i>Kelvin color temperature - cool lights</i>
	A richiesta 4000K <i>On request 4000K</i>
	A richiesta 6000K <i>On request 6000K</i>
	Controllo dell'illuminazione in modo facile, con un dimming continuo. <i>Easy access mode for controlling the illumination, a continuous dimming.</i>
	Versatile e funzionale l'impianto DALI può essere integrato facilmente nei sistemi di automazione per edifici già esistenti <i>Versatile and functional, the DALI-mode function can be easily integrated in the automation-systems for already existing buildings</i>
	Sistema di controllo della luminosità attraverso pulsanti NA <i>Brightness control system through NO buttons</i>
	Driver incluso nel prodotto <i>Driver included in the product</i>
	Driver non incluso, da ordinare a parte <i>Not included driver, to be ordered separately</i>
	Tutti gli apparecchi di illuminazione di questo catalogo utilizzano un Driver LED "MULTIPOWER". A richiesta, per quantità, è possibile cambiare in fabbrica la taratura della corrente e, di conseguenza potenza (W) e Lumen (Lm) <i>All the luminaires in this catalog use a "MULTIPOWER" LED Driver. On request, for quantity, it is possible to change the current calibration in the factory and, consequently, power (W) and Lumen (Lm)</i>
Il flusso luminoso uscente dall'apparecchio viene indicato con una tolleranza di ± 10%. <i>The luminous flux exiting the fixture is indicated with a tolerance of ± 10%.</i>	

* Lm Output

La certificazione fotometrica dei nostri apparecchi viene sempre effettuata da un laboratorio fotometrico esterno. Efficienza luminosa e Lumen Output sono quindi il risultato di un ente terzo, in alcun modo vincolato a Relco S.r.l.
The photometric certification of our appliances is always carried out by an external photometric laboratory. Luminous efficiency and Lumen Output are therefore the result of a third party, in no way bound to Relco S.r.l.

Legenda simboli - Symbols legend

Applicazione apparecchi - <i>Appliance application</i>	
	Adatto per installazione in luoghi di culto. <i>Suitable for installation in places of worship.</i>
	Adatto per installazione in Hotel, Alberghi e luoghi di soggiorno. <i>Suitable for installation in hotels and places to stay.</i>
	Adatto per installazione in aule scolastiche. <i>Suitable for installation in classrooms.</i>
	Adatto per installazione in uffici con stazionamento di addetti a videoterminale. <i>Suitable for installation in offices with employees working at video terminals.</i>
	Adatto per installazione in uffici, corridoi, sale riunioni. <i>Suitable for installation in offices, corridors, meeting rooms.</i>
	Adatto per installazione in palestre, centri sportivi. <i>Suitable for installation in gyms, sports centres.</i>
	Adatto per illuminazione di opere d'arte, quadri. <i>Suitable for lighting works of art, paintings.</i>
	Adatto per installazione in Ospedale. <i>Suitable for installation in hospitals.</i>
	Adatto per installazione in Ipermercati, Supermercati. <i>Suitable for installation in hypermarkets, supermarkets.</i>
	Adatto per installazione in negozi in genere. <i>Suitable for installation in shops in general.</i>
	Adatto per installazione in parcheggi. <i>Suitable for installation in car parks.</i>
	Adatto per installazione all'aperto, terrazzi anche scoperti. <i>Suitable for installation outdoors, even open terraces.</i>
	Adatto per installazione in bagni. <i>Suitable for installation in bathrooms.</i>
	Adatto per installazione in zone umide. <i>Suitable for installation in wet areas.</i>
Colore corpo apparecchi - <i>Luminaire body color</i>	
	Bianco - <i>White</i>
	Nero - <i>Black</i>
	Grigio - <i>Grey</i>
	Argento sabbia - <i>Sanded silver</i>

	Argento - <i>Silver</i>
	Alluminio lucido - <i>Polished aluminum</i>
	Trasparente - <i>Transparent</i>
	Cromo - <i>Chrome</i>
	Oro - <i>Gold</i>
	Argento lucido - <i>Polished Silver</i>
	Trasparente - <i>Transparent</i>
	Specchio - <i>Mirror</i>
	Vetro satinato - <i>Frosted glass</i>
	Vetro fumè - <i>Fumè glass</i>
	Cromo - <i>Chrome</i>
	Rame - <i>Copper</i>
	Arancio - <i>Orange</i>
	Rosa - <i>Pink</i>
	Blu - <i>Blue</i>
	Vintage - <i>Vintage</i>
	Nikel - <i>Nikel</i>
	Wenghè - <i>Wenghè</i>
Colori paralumi - <i>Colour lampshade</i>	
	Bianco - <i>White</i>
	Écru - <i>Écru</i>
	Nero - <i>Black</i>
	Rosso - <i>Red</i>



Light Emitting Diode

Il LED, Light Emitting Diode, diodo ad emissione di luce, è un dispositivo semiconduttore che genera luce al passaggio di cariche elettriche attraverso una giunzione in silicio opportunamente eccitato. Diversamente dalle sorgenti di luce tradizionali il LED non "brucia" ma nel tempo riduce l'intensità della luce emessa. La durata di vita dipende sia da una corretta progettazione della dissipazione termica dell'apparecchio illuminante, che dal driver che lo alimenta.

Negli anni il LED ha migliorato le prestazioni sia in termini di resa cromatica, fino ad arrivare ad un CRI>95, che di flessibilità nella temperatura di colore, che ha un range tra i 2700 K e i 6500 K. A tutte queste migliorie, proprie del LED, si aggiungono anche una serie di accessori abbinati allo stesso, che Relco può fornire, come driver dimmerabili, sensori di luminosità e di movimento, riducendo le emissioni di CO2.



Vantaggi

- Durata di vita utile elevata (50.000h).
- Efficienza luminosa, fino ad 160lm/W.
- Regolazione del flusso luminoso (dimmerazione) a partire dall'1%.
- Flessibilità e compattezza dei moduli per un'ampia possibilità di utilizzo.
- Emissione di luce colorata senza utilizzo di filtri.
- Possibilità di controllo dinamico dei colori e bianco dinamico.
- Accensione immediata già a bassissime temperature (-35°).
- Assenza di componenti IR e UV nell'intero spettro elettromagnetico.
- Sicurezza fotobiologica.
- Riduzione dei costi di manutenzione.
- Dimezzamento dei consumi energetici.
- Rientro dell'investimento in breve tempo.

Light Emitting Diode

Light-emitting diode (LED) is a semiconductor light source that emits light when current flows through it.

Differently from the conventional types of light bulbs LED doesn't "burn", but with time reduces the amount of light emitted. The life time depends firstly on a correct design of the heat dissipation of the lighting fixture and secondly by the driver which feeds it.

In the current years LED has improved its performance both in terms of color rendering where we can reach up to CRI>95 and also in the flexibility of the different color temperatures where it has a range from 2700K up to 6500K.

Other than all these improvements, there are also a series of accessories to combine with LED that Relco can supply such as dimmable drivers, motion and light sensors which reduce the CO2 emissions.

Advantages

- Long life time (50.000 hrs).
- High light put efficiency, up to 160lm/W.
- Regulation of the light flux (dimming) starting from 1%.
- Flexibility and compactness of the modules for a wide range of utilization.
- Emission of colored light without filters.
- Possibility of dynamic control of colors and also dynamic white.
- Immediate power even at low temperatures (-35°).
- Exemption of IR and UV rays.
- Photobiologic safety.
- Reduction of maintenance costs.
- Reduction of energy consumption.
- Economic return in a short period.

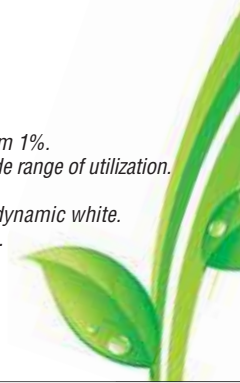

LED Micro Pinguino - LED Pinguino - LED Puma - LED Maxi Puma

La certificazione fotometrica dei nostri apparecchi viene sempre effettuata da un istituto esterno. Efficienza luminosa e "lm Output" sono quindi il risultato di tale istituto.

The photometric certification of our appliances is always carried out by an external institute. Luminous efficiency and "lm Output" are therefore the result of this institute.

Gamma completa di proiettori ideale per illuminare parcheggi, piazzali, facciate, zone carico-scarico e grandi aree in generale.

Installazione: su superfici verticali e orizzontali.

Corpo e telaio: in alluminio pressofuso UNI EN 1706 verniciato con polvere termoindurente poliestere.

Staffa di fissaggio: in acciaio, verniciata con polvere termoindurente poliestere, con goniometro graduato per un corretto puntamento del fascio luminoso.

Verniciatura: di tipo poliestere eseguita a polvere, resistente agli agenti atmosferici, alla corrosione. Grigio RAL 9007.

Ottica: concentrante, semi concentrante, diffondente e asimmetrica.

Schermo: vetro temprato di spessore 4mm resistente agli shock termici e agli urti.

Sorgente: LED **SAMSUNG**

Temperatura di colore: 4000K; altre temperature di colore a richiesta (2200K - 2700K - 3000K - 5000K - Consegna 60 giorni).

Protezione alle sovratensioni inclusa:

Modo differenziale 6kV (L-N)

Modo comune 8kV (L-GND, N-GND, L&N-GND)

A richiesta: versione con protezione maggiorata (10kV) contro gli impulsi aggiungendo il cod. RO0640/N.

Mantenimento del flusso luminoso minimo al 80% - 80.000h (L80B20).

Driver: incorporato 
Fattore di potenza $\geq 0,95$.

Norme di riferimento: IEC 61000-4-5; EN60598-1; EN60598-2-1; EN62471; EN62031; EN60598-2-5; EN61547

Complete range projectors perfect to light up car parks, squares, facades, loading and unloading areas and large areas in general.

Installation: on vertical and horizontal surfaces.

Housing and frame: made by UNI EN 1706 die-cast aluminum, coated with polyester thermoset powder.

Fixing bracket: made by stainless steel, coated with polyester thermoset powder, with graduated goniometer to allow the correct orientation of light beam

Coating: coated with powdered polyester, resistant to atmospheric agents and corrosion. RAL 9007 Grey.

Optic: clumping, semi-clumping, diffused and asymmetric

Shield: tempered glass with 4mm thickness resistant to thermal shocks and collisions.

Light source: LED **SAMSUNG**

Color temperature: 4000K; other color temperatures available on demand (2200K - 2700K - 3000K - 5000K. Delivery time: 60 days)

Protection against overvoltages included:

Differential mode 6kV (L-N)

Standard mode 8kV (L - GND, N-GND, L&N-GND).

Maintenance of minimum luminous flux to 80% - 80.000h (L80B20).

Driver: included 
Power factor $\geq 0,95$

Standard reference: IEC 61000-4-5; EN60598-1; EN60598-2-1; EN62471; EN62031; EN60598-2-5; EN61547

LED Micro Pinguino - LED Pinguino - LED Puma - LED Maxi Puma



LED Maxi Puma - LED Maxi Puma ASY

LED Puma - LED Puma ASY

LED Pinguino - LED Pinguino ASY

LED Micro Pinguino



Floodlight

A richiesta - On demand



Vedi Pag. VI - See page VI

220-240 Vac	110 Vac On demand	50/60 Hz	IP66	IK09	CRI > 80	+40 C -20	850°		CE		
	TECEE		RG0		LOW FLICKER		Driver included MULTIPOWER RIPPLE FREE				

LED Micro Pinguino

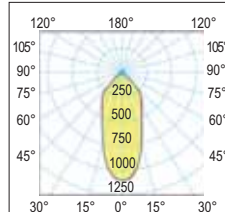

40°
Intermedio - Medium



colour	W	angle	K	nominal lm tc = 25°C	lm output	lm/W	pcs	Kg	CELL
B	15	40°	3000	2100	1400	90	8	0,50	28211/LED
B	15	40°	4000	2100	1400	90	8	0,50	28212/LED
G	15	40°	3000	2100	1400	90	8	0,50	28213/LED
G	15	40°	4000	2100	1400	90	8	0,50	28214/LED
N	15	40°	3000	2100	1400	90	8	0,50	28215/LED
N	15	40°	4000	2100	1400	90	8	0,50	28216/LED

A richiesta: ottica 25° - On demand: optic 25°

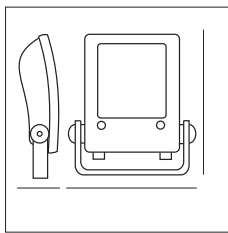

LED Pinguino

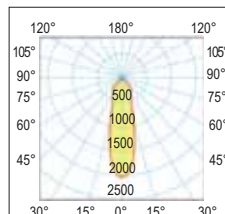

25°
Semi-concentrate - Spot

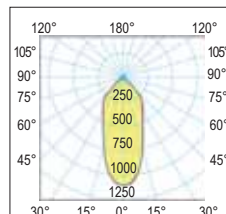

40°
Intermedio - Medium

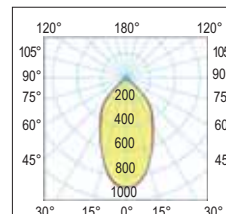

60°
Semi-diffondente - Flood

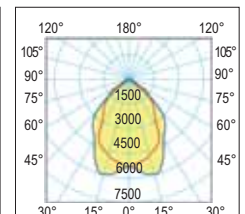

90°
Diffondente - Wide

1-10Vdc

1-10Vdc

DALI 2

1-10Vdc

colour	W	angle	K	nominal lm tc = 25°C	lm output	lm/W	pcs	Kg	CELL
G	35	25°	4000	5870	4514	132	4	3,20	28203/LED/25
G	70	25°	4000	8470	7700	110	4	3,20	28208LED25S
G	35	40°	4000	5870	4514	132	4	3,20	28203/LED/40
G	70	40°	4000	8470	7700	110	4	3,20	28208LED40S
G	35	60°	3000	5870	4514	132	4	3,20	28203/L/60-3K
G	35	60°	4000	5870	4514	132	4	3,20	28203/LED/60
G	35	60°	4000	5870	4514	132	4	3,20	28203/LED60DA
G	70	60°	4000	8470	7700	110	4	3,20	28208LED60S
G	100	90°	3000	12100	11000	110	4	3,50	28209/L/S-3K
G	100	90°	4000	12100	11000	110	4	3,50	28209/LED/S

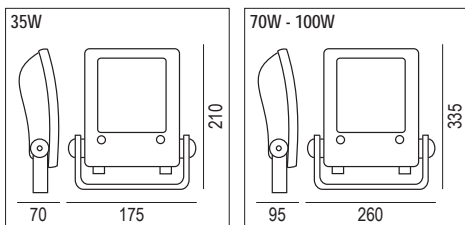

LED Pinguino Eye - Luce solo all'occorrenza - Light only when needed

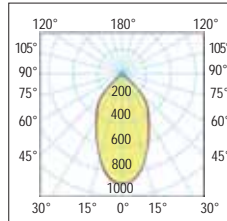

60°
Semi-diffondente - Flood

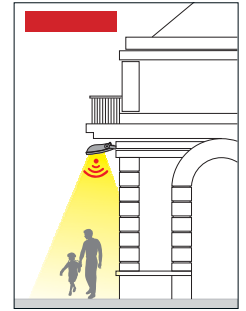
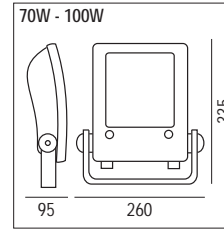
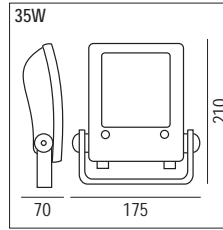

colour	W	angle	K	nominal lm tc = 25°C	lm output	lm/W	pcs	Kg	CELL
G	15	60°	4000	2200	1800	120	4	0,50	28203/LED/EYE
G	30	60°	3000	4400	3600	120	4	0,50	28205/LED/EYE
G	30	60°	4000	4400	3600	120	4	0,50	28206/LED/EYE

A richiesta: per quantità minima 100 pezzi disponibili a 2700K - *On demand: for quantity min 100 pcs available 2700K*

LED Pinguino ASY

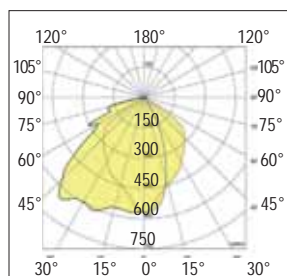
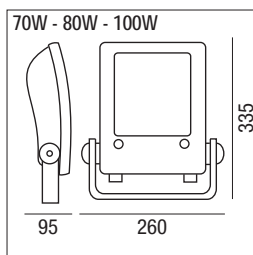
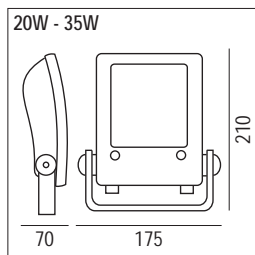

ASY
Asimmetrico - Asymmetric

	colour	W	angle	K	nominal lm tc = 25°C	lm output	lm/W	pcs	Kg	CELL
	G	20	ASY	3000	3400	3000	150	4	3,20	20ASY-3K
	G	20	ASY	4000	3400	3000	150	4	3,20	20ASY-4K
DYNA	G	20	ASY	3000	3400	3000	150	4	3,20	35ASYDYNA5-3K
DYNA	G	20	ASY	4000	3400	3000	150	4	3,20	35ASYDYNA5-4K
	G	35	ASY	3000	5.000	4.400	125	4	3,20	28203/L/AS-3K
	G	35	ASY	4000	5.000	4.400	125	4	3,20	28203/LED/AS
DYNA	G	35	ASY	3000	5.000	4.400	125	4	3,20	50ASYDYNA5-3K
DYNA	G	35	ASY	4000	5.000	4.400	125	4	3,20	50ASYDYNA5-4K
1-10Vdc	G	70	ASY	3000	10.000	8.750	125	4	3,20	28208LEDAS3KS
1-10Vdc	G	70	ASY	4000	10.000	8.750	125	4	3,20	28208LEDASS
DYNA	G	70	ASY	3000	10.000	8.750	125	4	3,20	75ASYDYNA5-3K
DYNA	G	70	ASY	4000	10.000	8.750	125	4	3,20	75ASYDYNA5-4K
DYNA	G	80	ASY	3000	11.500	10.000	125	4	3,20	100ASYDYNA53K
DYNA	G	80	ASY	4000	11.500	10.000	125	4	3,20	100ASYDYNA54K
	G	100	ASY	3000	14.300	12.500	125	4	3,20	28209/L/AS-3K
	G	100	ASY	4000	14.300	12.500	125	4	3,20	28209/LED/AS



LED Puma ASY

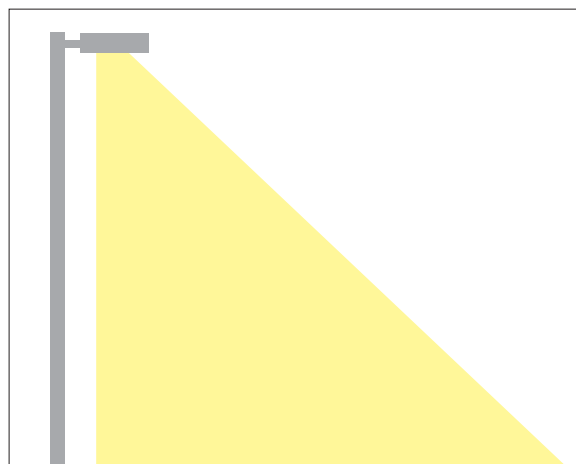
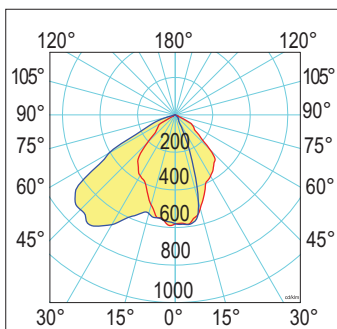

ASY
Asimmetrico - *Asymmetric*

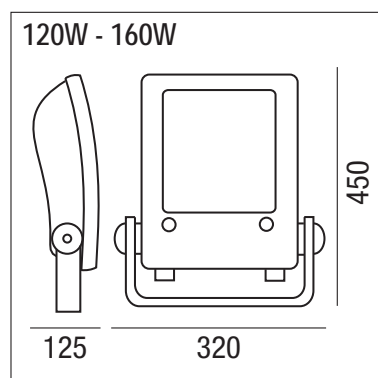

- 1-10Vdc
- 1-10Vdc
- DYNA
- DYNA
- DYNA
- DYNA

colour	W	angle	K	nominal lm tc = 25°C	lm output	lm/W	pcs	Kg	CELL
G	120	ASY	3000	19.300	16800	140	2	5,80	28234LEDAS3KS
G	120	ASY	4000	19.300	16800	140	2	5,80	28234LEDASS
G	120	ASY	3000	19.300	16800	140	2	5,80	28234ASDNA53K
G	120	ASY	4000	19.300	16800	140	2	5,80	28234ASDNA54K
G	160	ASY	3000	25.700	22400	140	2	6,20	28259LEDAS3K
G	160	ASY	4000	25.700	22400	140	2	6,20	28259LEDAS
G	160	ASY	3000	25.700	22400	140	2	6,20	28259ASDNA53K
G	160	ASY	4000	25.700	22400	140	2	6,20	28259ASDNA54K

LED Puma

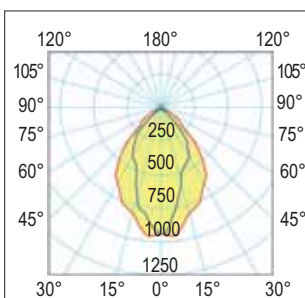

40°/80°
Ovale diffondente - *Oval flood*

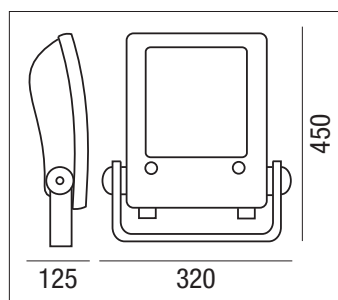

- 1-10Vdc
- 1-10Vdc
- DALI 2
- DALI 2

colour	W	angle	K	nominal lm tc = 25°C	lm output	lm/W	pcs	Kg	CELL
G	120	40/80°	3000	19.300	16.800	140	2	5,80	28234LED803KS
G	120	40/80°	4000	19.300	16.800	140	2	5,80	28234LED80S
G	120	40/80°	4000	19.300	16.800	140	2	5,80	28234LED80DA
G	160	40/80°	3000	25.700	22.400	140	2	6,20	28259LED803K
G	160	40/80°	4000	25.700	22.400	140	2	6,20	28259LED80
G	160	40/80°	4000	25.700	22.400	140	2	6,20	28259LED80DA



A richiesta LED Puma può essere fornito anche in versione emergenza - + Euro 200,00 da prezzo di listino (aggiungere /E dopo il codice)
On request, LED Puma can also be supplied in an emergency version - + Euro 200.00 from the list price (add / E after the code)

LED Maxi Puma ASY

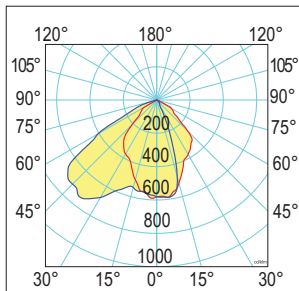

ASY
Asimmetrico - *Asymmetric*

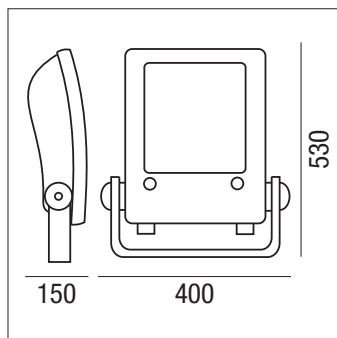

colour	W	angle	K	nominal lm tc = 25°C	lm output	lm/W	pcs	Kg	CELL
G	220	ASY	3000	35.400	30.800	140	2	10,00	28235LEDAS3K
G	220	ASY	4000	35.400	30.800	140	2	10,00	28235LEDAS
1-10Vdc	G	220	ASY	3000	35.400	30.800	2	10,00	28235LEDAS3KS
1-10Vdc	G	220	ASY	4000	35.400	30.800	2	10,00	28235LEDASS
DALI 2	G	220	ASY	3000	35.400	30.800	2	10,00	28235LEDAS3KD
DALI 2	G	220	ASY	4000	35.400	30.800	2	10,00	28235LEDASD



A richiesta LED Puma può essere fornito anche in versione emergenza - + Euro 200,00 da prezzo di listino (aggiungere /E dopo il codice)
On request, LED Puma can also be supplied in an emergency version - + Euro 200.00 from the list price (add / E after the code)

LED Maxi Puma

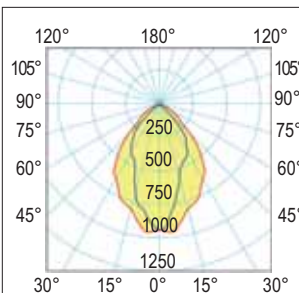

40°/80°
Ovale diffondente - *Oval flood*

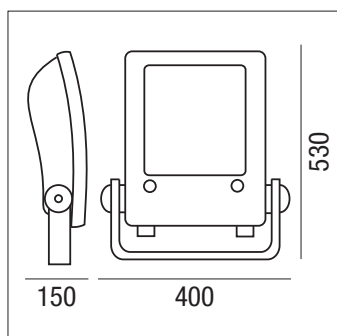

colour	W	angle	K	nominal lm tc = 25°C	lm output	lm/W	pcs	Kg	CELL
G	220	40/80°	3000	35.400	30.800	140	2	10,00	28235LED803K
G	220	40/80°	4000	35.400	30.800	140	2	10,00	28235LED80
1-10Vdc	G	220	40/80°	3000	35.400	30.800	2	10,00	28235LED803KS
1-10Vdc	G	220	40/80°	4000	35.400	30.800	2	10,00	28235LED80S
DALI 2	G	220	40/80°	3000	35.400	30.800	2	10,00	28235LED803KD
DALI 2	G	220	40/80°	4000	35.400	30.800	2	10,00	28235LED80D



A richiesta LED Puma può essere fornito anche in versione emergenza - + Euro 200,00 da prezzo di listino (aggiungere /E dopo il codice)
On request, LED Puma can also be supplied in an emergency version - + Euro 200.00 from the list price (add / E after the code)

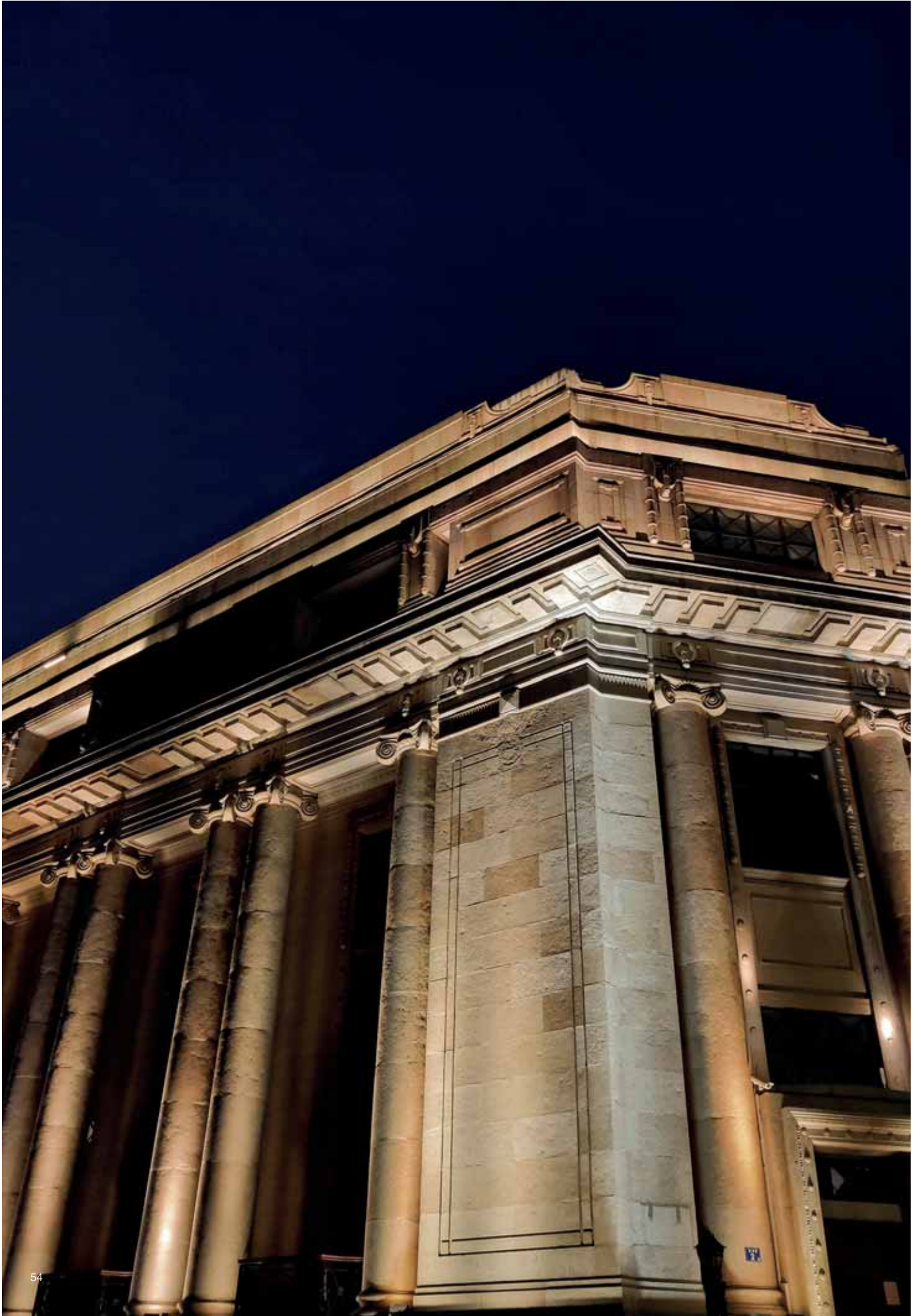

LED Pinguino - LED Puma

Dettagli - Details



Staffa di fissaggio ruotabile con goniometro. Doppia vite bloccastaffa per resistenza al vento.
Rotating support with goniometer and double bracket blocking screws against the wind.

Alette di raffreddamento maggiorate, pressacavo IP66.
Cooling grilles, IP66 cable gland.



Dispositivo anticondensa: valvola di compensazione e riciclo dell'aria.
Anti-condensate device: valve for compensation and circulation of air.



Tutti i modelli LED Pinguino e LED Puma sono completi di connettore IP68 per una rapida installazione
All LED Pinguino and LED Puma models are complete with IP68 connector for quick installation

Soluzioni NON incluse per aumentare il risparmio energetico *NOT included solutions to increase energy saving*

Fig. 1 - Esempio applicativo 2 steps - Application example 2 steps

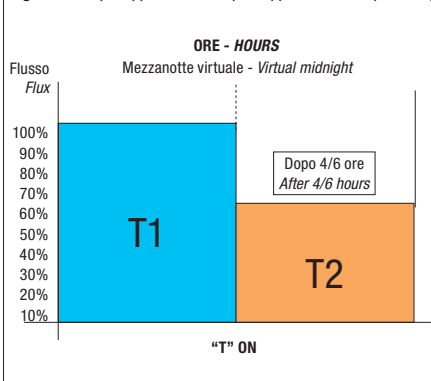

T1 = 100% Flusso luminoso
T1 = 100% Luminous flux
T2 = 70% Flusso luminoso
T2 = 70% Luminous flux

Minimo tempo di accensione per funzionamento automatico 4 ore (3 giorni). Accensioni da 1 a 4 ore oppure superiori alle 23 ore resettano il sistema.
The minimum ignition time for automatic operation is 4 hours (three days). Ignitions 1 hour ignored. Switching from 1 to 4 hours or higher with 23 hours reset the system.

DYNA CONTROL è un sistema di controllo del flusso luminoso delle lampade che si basa sul calcolo della mezzanotte virtuale. Il sistema entra in funzione alla prima accensione calcolando per 3 giorni i tempi di accensione. Il quarto giorno il sistema, in modo autonomo, calcola la mezzanotte virtuale eseguendo una regolazione del flusso e regolando la lampada come indicato sullo schema di Fig. 1. La riduzione del flusso luminoso avviene senza la necessità di alcun cavo di connessione aggiuntivo o dispositivo di comando esterno, questo sistema consente di ottenere un notevole risparmio energetico. N.B. su richiesta è possibile eseguire la modifica delle impostazioni di fabbrica della mezzanotte virtuale adattandole alle specifiche del cliente.

DYNA CONTROL is a control system for the luminous flux of the lamps which is based on virtual midnight calculation. The system starts running when turned on for the first time, calculating the start-up times for 3 days. On the fourth day, the system automatically calculates the virtual midnight by performing a flux adjustment and adjusting the lamp as indicated on the diagram of Fig. 1. The reduction of the luminous flux occurs without the need for any additional connection cable or external control device. This system can achieve considerable energy saving. N.B. the factory settings of the virtual midnight can be modified on request, adjusting them to the customer's specifications.

Accessori non inclusi - Not included accessories



Code: RO0640/N

Dispositivo di protezione conforme alla Norma EN 61547 contro i fenomeni impulsivi atto a proteggere il modulo LED e il relativo alimentatore: classe II (a richiesta protezione fino a 10kV)
Protection device in compliance with the EN 61547 standard to counteract the impulsive phenomena designed to protect the LED module and the relative power supply: class II (protection up to 10kV available on request)

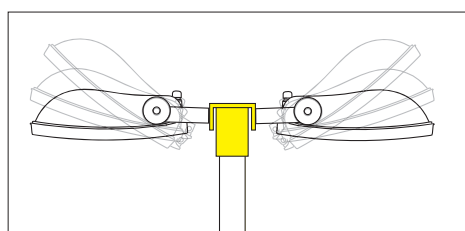
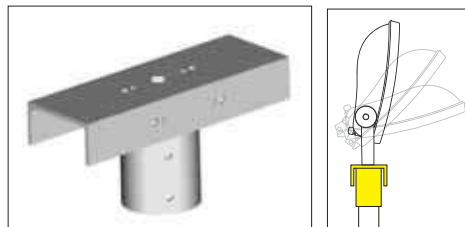

Code: 703952.NEW

Attacco palo per 1 o 2 proiettori, Ø 60/76 mm in ferro verniciato con polveri termoindurenti poliesteri resistenti alla corrosione ed agli agenti atmosferici.
Pole attachment for either 1 or 2 floodlights, size Ø60/76mm made by iron coated with polyester thermosetting powder, offering high resistance to rust and external atmospheric agents



Code: 24184

Staffa per applicazione a parete (solo per i modelli LED Pinguino 70W e LED Pinguino 100W)
Stirrup for wall application (only for LED Pinguino 70W and LED Pinguino 100W models)

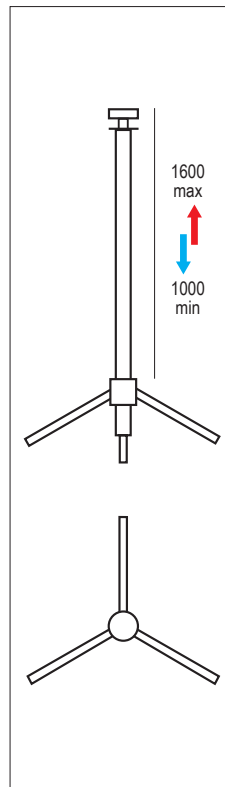

Cod. 24181

Cavalletto estensibile 1x - Extendable stand 1x



BASIC series LED Virgola



Gamma di proiettori da esterno in alluminio pressofuso ideale per illuminare aree verdi, giardini, parcheggi, piazzali, facciate, zone di carico-scarico e grandi aree in generale.

Installazione: su superfici verticali e orizzontali (completo di staffa di fissaggio) con corpo e telaio in alluminio pressofuso UNI 5076 di tipo poliestere eseguita a polvere, resistente agli agenti atmosferici, alla corrosione e staffa di fissaggio in acciaio, verniciata con polvere termoisolante poliestere.

Range of outdoor projectors made by die-cast aluminum perfect to light up parks, gardens, car parks, squares, facades, loading and unloading areas and large areas in general.

Installation: on vertical and horizontal surfaces (complete with fixing bracket), with housing and frame made by UNI 5076 die-cast aluminum, coated with powdered polyester, resistant to atmospheric agents and corrosion and fixing bracket made by stainless steel, coated with polyester thermoset powder.

50/60 Hz	100-264 Vac	IP65	IK08	CRI > 80	+40 C° -20	850°		CE			
Driver included											



LED Virgola 50W

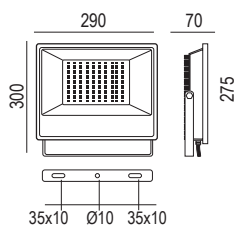

LED Virgola 100W

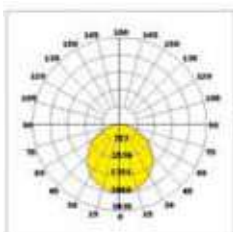
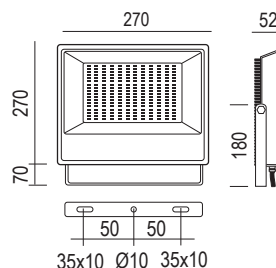

colour	W	angle	K	lm output	lm/W	pcs	Kg	CELL
N	50	120°	4000	6.000	120	1	1,00	27303/NEW
N	100	120°	4000	12.000	120	1	2,10	RL2180362

Colore nero RAL 9004.

Ottica: diffondente 120°

Schermo: vetro temprato di spessore 4mm resistente agli shock termici e agli urti.

Sorgente LED SMD: incorporato con temperatura di colore 4000K; altre temperature di colore a richiesta.

Driver: incorporato fattore di potenza: $\geq 0,9$

RAL 9004 black color.

Optic: 120° diffused

Shield: tempered glass with 4mm thickness resistant to thermal shocks and collisions

Light source SMD LED: included with color temperature 4000K; other color temperatures available on demand.

Driver: included Power factor: $\geq 0,9$



Pressacavo IP65
Waterproof
connector IP65



Dissipatore in alluminio
pressofuso per un'ottima
dissipazione del calore.
Die casting aluminum,
excellent heat disipation.



LED Virgola 150W

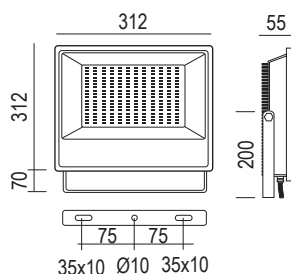

LED Virgola 200W

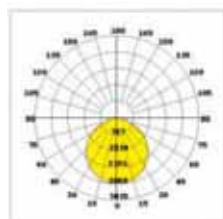
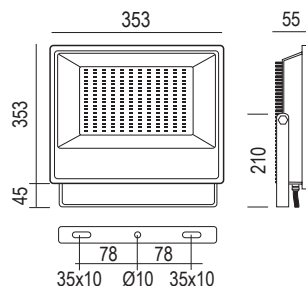

colour	W	angle	K	lm output	lm/W	pcs	Kg	CELL
N	150	120°	4000	15.000	100	1	3,20	RL2180372
N	200	120°	4000	20.000	100	1	3,60	RL2180382

Installazione con rotazione 360°
intallation 360° rotation

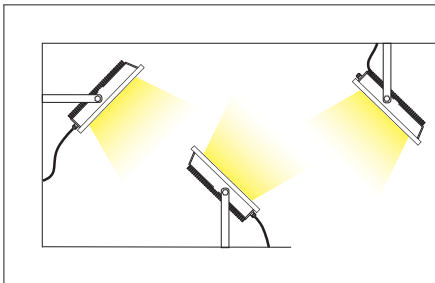

A richiesta
On request

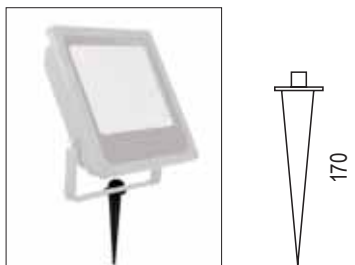

Cod. 24165
Picchetto in alluminio.
Utilizzabile per tutti i modelli.
Aluminium spike.
Usable for all models.

(A)



(A) Cod. 24181 - 100>160cm
Cavalletto estensibile.
Utilizzabile per tutti i modelli.
Extendable stand. Usable for all models.

LED Tigre - LED Tigre ASY



Gamma completa di proiettori da esterno ideale per illuminare parcheggi, piazzali, facciate, zone carico-scarico e grandi aree in generale.

Installazione: a palo o a parete.

Corpo e telaio: in alluminio pressofuso UNI EN 1706 verniciato con polvere termoindurente poliestere.

Staffa di fissaggio: in acciaio, verniciata con polvere termoindurente poliestere, con goniometro graduato per un corretto puntamento del fascio luminoso.

Verniciatura: di tipo poliestere eseguita a polvere, resistente agli agenti atmosferici, alla corrosione. Grigio RAL 9007.

Ottica: semi concentrante, intermedia, semi-diffondente e asimmetrica.

Schermo: vetro temprato trasparente di spessore 4mm resistente agli shock termici e agli urti.

Sorgente: LED **SAMSUNG**

Mantenimento del flusso luminoso minimo al 90% - 100.000h (L90B10) per il 90% dei LED.

Temperatura di colore: 4000K; altre temperature di colore a richiesta (2200K - 2700K - 3000K - 5000K
Consegna 60 giorni).

Driver: **PHILIPS** incorporato .
Fattore di potenza $\geq 0,95$.

Protezione alle sovratensioni inclusa:

Modo differenziale 6kV (L-N)

Modo comune 8kV (L-GND, N-GND, L&N-GND)

A richiesta: versione con protezione maggiorata (10kV) contro gli impulsi aggiungendo il cod. RO0640/N.

Norme di riferimento: IEC 61000-4-5; EN60598-1; EN60598-2-1; EN62471; EN62031; EN60598-2-5; EN61547

Complete range of outdoor projectors perfect to light up car parks, squares, facades, loading and unloading areas and large areas in general.

Installation: on pole or wall

Housing and frame: made by UNI EN 1706 die-cast aluminum, coated with polyester thermoset powder.

Fixing bracket: made by stainless steel, coated with polyester thermoset powder, with graduated goniometer to allow the correct orientation of light beam

Coating: coated with powdered polyester, resistant to atmospheric agents and corrosion. RAL9007 Grey.

Optic: spot, medium, flood and asymmetric.

Shield: transparente tempered glass with 4mm thickness resistant to thermal shocks and collisions

Light source: LED **SAMSUNG**

Maintenance of minimum luminous flux to 90% - 100.000h (L90B10) for 90% of LED.

Color temperature: 4000K; other color temperatures available on demand (2200K - 2700K - 3000K - 5000K.
Delivery time: 60 days)

Driver: **PHILIPS included** .
Power factor $\geq 0,95$

Protection against overvoltages included:

Differential mode 6kV (L-N)

Standard mode 8kV (L - GND, N-GND, L&N-GND).

Standard reference: IEC 61000-4-5; EN60598-1; EN60598-2-1; EN62471; EN62031; EN60598-2-5; EN61547

La certificazione fotometrica dei nostri apparecchi viene sempre effettuata da un istituto esterno. Efficienza luminosa e "Im Output" sono quindi il risultato di tale istituto.

The photometric certification of our appliances is always carried out by an external institute. Luminous efficiency and "Im Output" are therefore the result of this institute.

A richiesta - On demand



Vedi Pag. VI - See page VI

220-240 Vac	110 Vac On demand	50/60 Hz	IP66	IK09	CRI > 80	+40 C -20	850°		CE		17 pending	
		RG0	LOW FLICKER	Driver included MULTIPOWER RIPPLE FREE								

LED Tigre

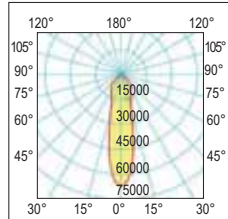
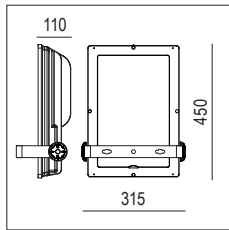

25°
Semi-concentrate - Spot

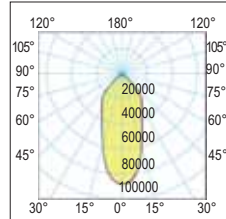

40°
Intermedio - Medium

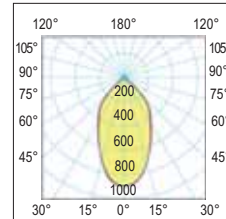

60°
Semi-diffondente - Flood

	colour	W	angle	K	nominal lm tc = 25° C	lm output	lm/W	pcs	Kg	CELL
1-10Vdc	G	160	25°	3000	25.700	22.400	140	1	7,50	28700/L/253KS
1-10Vdc	G	160	25°	4000	25.700	22.400	140	1	7,50	28700/LED/25S
1-10Vdc	G	160	40°	3000	25.700	22.400	140	1	7,50	28700/L/403KS
1-10Vdc	G	160	40°	4000	25.700	22.400	140	1	7,50	28700/LED/40S
1-10Vdc	G	160	60°	3000	25.700	22.400	140	1	7,50	28700/L/603KS
1-10Vdc	G	160	60°	4000	25.700	22.400	140	1	7,50	28700/LED/60S
1-10Vdc	G	220	25°	4000	35.400	30.800	140	1	7,50	28701/LED/25S
DALI 2	G	220	25°	4000	35.400	30.800	140	1	7,50	28701/L/25/DA
G	200	40°	4000	31.600	28.000	140	1	7,50	28701/TV/40	
DALI 2	G	200	40°	4000	31.600	28.000	140	1	7,50	28701/TV/40D
1-10Vdc	G	220	40°	4000	35.400	30.800	140	1	7,50	28701/LED/40S
G	220	40°	4000	35.400	30.800	140	1	7,50	28701/LED/40	
G	200	60°	4000	31.600	28.000	140	1	7,50	28701/TV/60	
DALI 2	G	200	60°	4000	31.600	28.000	140	1	7,50	28701/TV/60D
1-10Vdc	G	220	60°	4000	35.400	30.800	140	1	7,50	28701/LED/60S
DALI 2	G	220	60°	4000	35.400	30.800	140	1	7,50	28701/L/60/DA

TV = Senza cornice (tutto vetro) - Without frame (all glass)

LED Tigre ASY

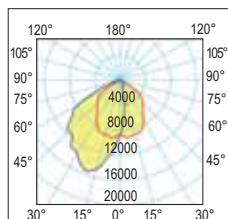
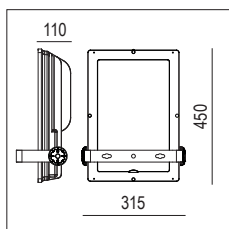

ASY
Asimmetrico - Asymmetric



	colour	W	angle	K	nominal lm tc = 25° C	lm output	lm/W	pcs	Kg	CELL
1-10Vdc	G	160	ASY	3000	25.700	22.400	140	1	7,50	28700/L/AS3KS
1-10Vdc	G	160	ASY	4000	25.700	22.400	140	1	7,50	28700/LED/ASS
DALI 2	G	160	ASY	4000	25.700	22.400	140	1	7,50	28700/L/AS/DA
G	200	ASY	4000	31.600	28.000	140	1	7,50	28701/TV/ASY	
DALI 2	G	200	ASY	4000	31.600	28.000	140	1	7,50	28701/TV/ASDA
1-10Vdc	G	220	ASY	4000	35.400	30.800	140	1	7,50	28701/LED/ASS
DALI 2	G	220	ASY	4000	35.400	30.800	140	1	7,50	28701/L/AS/DA

TV = Senza cornice (tutto vetro) - Without frame (all glass)

LED Tigre - LED Tigre ASY

Dettagli - Details



Led Driver Philips incorporati nel prodotto.

Protezione contro gli impulsi 8kV conforme alla Norma EN 61547.

Philips Led Driver incorporated in the product.

8kV Impulse protection in accordance with EN 61547.



Dispositivo anticondensa: valvola di compensazione e riciclo dell'aria.

Anti-condensate device: valve for compensation and circulation of air.



Alette di raffreddamento maggiorate, pressacavo IP66.

Cooling grilles, IP66 cable gland.



Completo di connettore IP68 per una rapida installazione

Complete with IP68 connector for quick installation

Accessori non inclusi - Not included accessories



Code: R00640/N

Dispositivo di protezione conforme alla Norma EN 61547 contro i fenomeni impulsivi atto a proteggere il modulo LED e il relativo alimentatore: classe II (a richiesta protezione fino a 10kV)

Protection device in compliance with the EN 61547 standard to counteract the impulsive phenomena designed to protect the LED module and the relative power supply: class II (protection up to 10kV available on request)

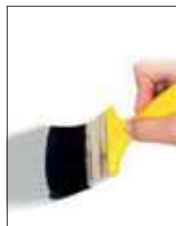

A richiesta: verniciatura resistente a 2.000 ore di esposizione alla nebbia salina in accordo alla norma ISO 9227 certificato da Ente esterno.

On request: painting resistant to 2,000 hours of exposure to salt spray in accordance with ISO 9227 certified by an external body.



Code: 11111

Staffa 2x per l'applicazione di due apparecchi - Bracket for the application of two lighting fixtures



Cod. 703952.NEW

Attacco palo per 1 o 2 proiettori, Ø60/76 mm. In ferro verniciato con polveri termoindurenti poliesteri resistenti alla corrosione ed agli agenti atmosferici.

Pole attachment for either 1 or 2 floodlights, size Ø 60/76mm. Iron coated with polyester thermosetting powder coating, offering high resistance to rust and external atmospheric agents.



Predisposto Zhaga Socket per sistemi wireless
Prepared for Zhaga Socket for wireless systems



Floodlight

LED Extreme 300 - 575 - 700 - ASY

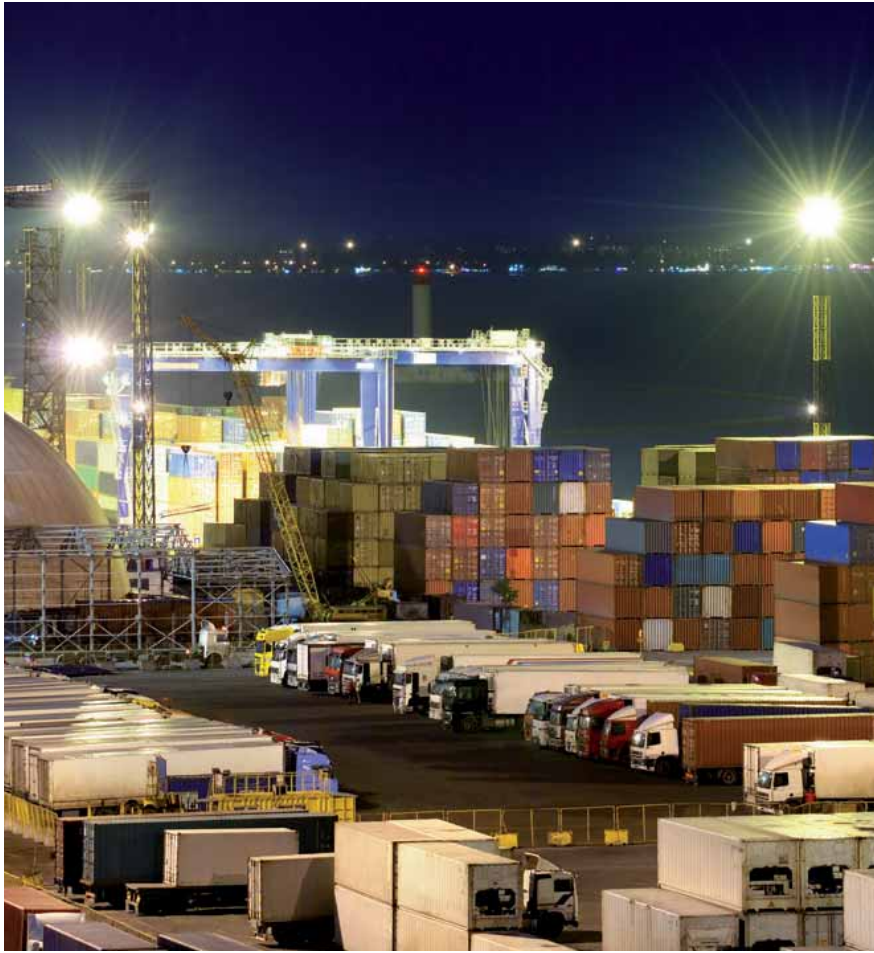

Innovativi proiettori a LED progettati per illuminare campi sportivi, stadi, aree di parcheggio, aeroporti e grandi aree in genere.

Installazione: su palo o parete/plafone (completo di staffa di fissaggio).

Corpo e telaio: in alluminio pressofuso UNI EN 1706 verniciato con polvere termoindurente poliester.

Staffa di fissaggio: in acciaio, verniciata con polvere termoindurente poliester, con goniometro graduato per un corretto puntamento del fascio luminoso.

Verniciatura: di tipo poliester eseguita a polvere, resistente agli agenti atmosferici e alla corrosione. Colore Grigio RAL 9007.

Ottica: concentrante, semi concentrante, diffondente e asimmetrica.

Schermo: vetro temprato di spessore 4mm resistente agli shock termici e agli urti

Sorgente: LED **SAMSUNG**

Temperatura di colore: 4000K; altre temperature di colore a richiesta (2200K - 2700K - 3000K - 5000K - Consegna 60 giorni).

Protezione alle sovratensioni inclusa:

Modo differenziale 6kV (L-N)

Modo comune 10kV (L-GND, N-GND, L&N-GND)

Mantenimento del flusso luminoso minimo al 80% - 50.000h (L80B10) per il 90% dei LED.

LED Driver PHILIPS:

Philips incorporato 

Conforme alla Norma: IEC 61000-4-5.

Fattore di potenza: $\geq 0,98$

Norme di riferimento: IEC 61000-4-5;

EN60598-1; EN60598-2-1; EN62471; EN62031;

EN60598-2-5; EN61547

Innovative LED projectors designed to light up sport fields, stadiums, car parks, airports and wide spaces in general.

Installation: on vertical and horizontal surfaces (complete with fixing bracket)

Housing and frame: made by UNI EN 1706 die-cast aluminum, coated with polyester thermoset powder.

Fixing bracket: made by stainless steel, coated with polyester thermoset powder, with graduated goniometer to allow the correct orientation of light beam

Coating: coated with powdered polyester, resistant to atmospheric agents and corrosion.

Grey colour RAL 9007

Optic: clumping, semi-clumping, diffused and asymmetric

Shield: tempered glass with 4mm thickness resistant to thermal shocks and collisions

*Light source: LED **SAMSUNG***

Color temperature: 4000K; other color temperatures available on demand (2200K - 2700K - 3000K - 5000K. Delivery time: 60 days)

Protection against overvoltages included:

Differential mode 6kV (L-N)

Standard mode 10kV (L - GND, N-GND, L&N-GND).

Maintenance of minimum luminous flux to 80% - 50.000h (L80B10) for 90% of LED.

LED Driver PHILIPS:

PHILIPS included 

Conforming to IEC 61000-4-5.

Power factor: $\geq 0,98$

Standard reference: IEC 61000-4-5; EN60598-1;

EN60598-2-1; EN62471; EN62031; EN60598-2-5;

EN61547



La certificazione fotometrica dei nostri apparecchi viene sempre effettuata da un istituto esterno. Efficienza luminosa e "lm Output" sono quindi il risultato di tale istituto.

The photometric certification of our appliances is always carried out by an external institute. Luminous efficiency and "lm Output" are therefore the result of this institute.

A richiesta - On demand

DYNA

Wireless

Vedi Pag. VI - See page VI

LED Extreme 300 - 575 - 700 - ASY



LED Extreme ASY - 275 - 400

LED Extreme 300 - 575 - 700

Floodlight



220-240 Vac	110 Vac On demand	50/60 Hz	IP66	IK08	CRI > 80	+40°C -40°C	+50°C -40°C	On demand	850°		
					LOW FLICKER						

LED Extreme 300

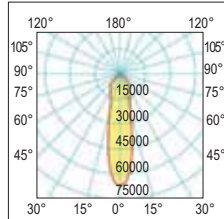
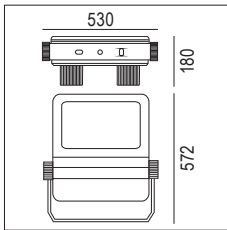

25°
Semi-concentrante - Spot

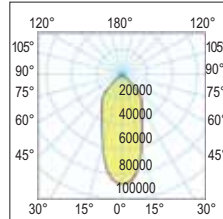

40°
Intermedio - Medium

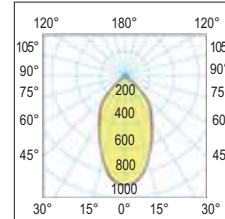

60°
Semi-diffondente - Flood

Driver DALI multipower PHILIPS incluso. A secondo delle esigenze è possibile diminuire la potenza e di conseguenza il valore dei Lumen

Included LED Driver DALI multipower PHILIPS. According to the needs it is possible to reduce the Wattage and consequently the value of the Lumens

colour	W	angle	K	nominal Im tc = 25°C	Im output	lm/W	pcs	Kg	CELL
G	300	25°	3000	48.300	42.000	140	1	16,00	455300.0320PL
G	300	25°	4000	48.300	42.000	140	1	16,00	455300.0420PL
G	300	40°	3000	48.300	42.000	140	1	16,00	455300.0340PL
G	300	40°	4000	48.300	42.000	140	1	16,00	455300.0440PL
G	300	40°	5000	48.300	42.000	140	1	16,00	455300.0540PL
G	300	60°	3000	48.300	42.000	140	1	16,00	455300.0360PL
G	300	60°	4000	48.300	42.000	140	1	16,00	455300.0460PL
G	300	25°	3000	48.300	42.000	140	1	16,00	555300.0320PL
G	300	25°	4000	48.300	42.000	140	1	16,00	555300.0420PL
G	300	40°	3000	48.300	42.000	140	1	16,00	555300.0340PL
G	300	40°	4000	48.300	42.000	140	1	16,00	555300.0440PL
G	300	40°	5000	48.300	42.000	140	1	16,00	555300.0540PL
G	300	60°	3000	48.300	42.000	140	1	16,00	555300.0360PL
G	300	60°	4000	48.300	42.000	140	1	16,00	555300.0460PL

LED Extreme 575

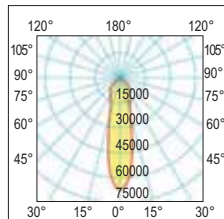
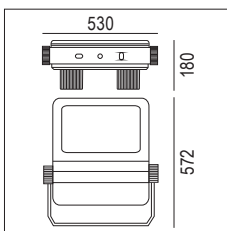

25°
Semi-concentrante - Spot

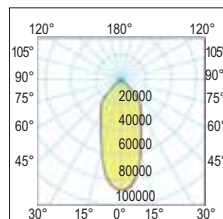

40°
Intermedio - Medium

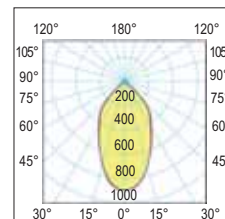

60°
Semi-diffondente - Flood

Driver DALI multipower PHILIPS incluso. A secondo delle esigenze è possibile diminuire la potenza e di conseguenza il valore dei Lumen

Included LED Driver DALI multipower PHILIPS. According to the needs it is possible to reduce the Wattage and consequently the value of the Lumens

colour	W	angle	K	nominal Im tc = 25°C	Im output	lm/W	pcs	Kg	CELL
G	500	25°	3000	80.500	70.000	140	1	22,00	455600.0320
G	500	25°	4000	80.500	70.000	140	1	22,00	455600.0420
G	500	40°	3000	80.500	70.000	140	1	22,00	455600.0340
G	500	40°	4000	80.500	70.000	140	1	22,00	455600.0440
G	500	40°	5000	80.500	70.000	140	1	22,00	455600.0540
G	500	60°	3000	80.500	70.000	140	1	22,00	455600.0360
G	500	60°	4000	80.500	70.000	140	1	22,00	455600.0460
G	500	25°	3000	80.500	70.000	140	1	22,00	555600.0320
G	500	25°	4000	80.500	70.000	140	1	22,00	555600.0420
G	500	40°	3000	80.500	70.000	140	1	22,00	555600.0340
G	500	40°	4000	80.500	70.000	140	1	22,00	555600.0440
G	500	40°	5000	80.500	70.000	140	1	22,00	555600.0540
G	500	60°	3000	80.500	70.000	140	1	22,00	555600.0360
G	500	60°	4000	80.500	70.000	140	1	22,00	555600.0460

LED Extreme 700

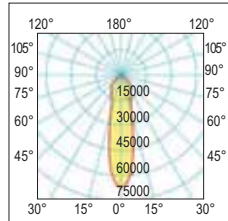
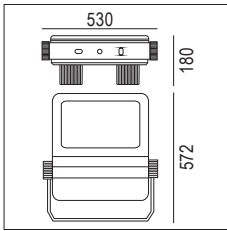

25°
Semi-concentrate - Spot

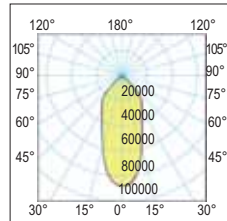

40°
Intermedio - Medium

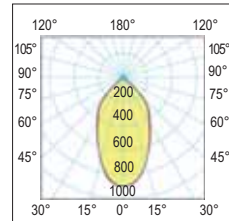

60°
Semi-diffondente - Flood

Driver DALI multipower PHILIPS incluso. A secondo delle esigenze è possibile diminuire la potenza e di conseguenza il valore dei Lumen

Included LED Driver DALI multipower PHILIPS. According to the needs it is possible to reduce the Wattage and consequently the value of the Lumens

colour	W	angle	K	nominal lm tc = 25°C	lm output	lm/W	pcs	Kg	CELL
G	600	25°	3000	96.600	84.000	140	1	20,90	455660.0320
G	600	25°	4000	96.600	84.000	140	1	20,90	455660.0420
G	600	40°	3000	96.600	84.000	140	1	20,90	455661.0340
G	600	40°	4000	96.600	84.000	140	1	20,90	455661.0440
G	600	40°	5000	96.600	84.000	140	1	20,90	455662.0540
G	600	60°	3000	96.600	84.000	140	1	20,90	455663.0360
G	600	60°	4000	96.600	84.000	140	1	20,90	455663.0460
G	600	60°	5000	96.600	84.000	140	1	20,90	455662.0560
DALI 2	G	600	25°	3000	96.600	84.000	1	20,90	555660.0320
DALI 2	G	600	25°	4000	96.600	84.000	1	20,90	555660.0420
DALI 2	G	600	40°	3000	96.600	84.000	1	20,90	555661.0340
DALI 2	G	600	40°	4000	96.600	84.000	1	20,90	555661.0440
DALI 2	G	600	40°	5000	96.600	84.000	1	20,90	555662.0540
DALI 2	G	600	60°	3000	96.600	84.000	1	20,90	555663.0360
DALI 2	G	600	60°	4000	96.600	84.000	1	20,90	555663.0460
DALI 2	G	600	60°	5000	96.600	84.000	1	20,90	555662.0560

LED Extreme ASY

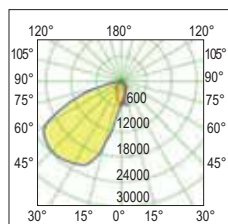
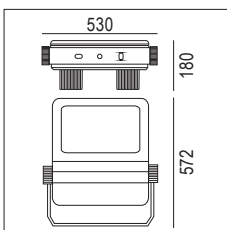

ASY
Asimmetrico - Asymmetric

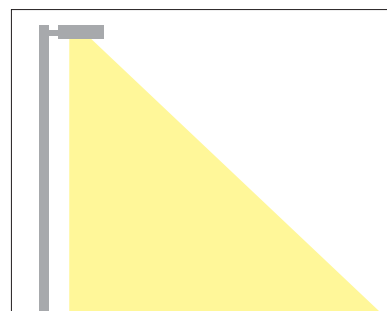

Driver DALI multipower PHILIPS incluso. A secondo delle esigenze è possibile diminuire la potenza e di conseguenza il valore dei Lumen

Included LED Driver DALI multipower PHILIPS. According to the needs it is possible to reduce the Wattage and consequently the value of the Lumens

colour	W	angle	K	nominal lm tc = 25°C	lm output	lm/W	pcs	Kg	CELL
G	275	ASY	3000	44.200	38.500	140	1	22,00	455300.A300
G	275	ASY	4000	44.200	38.500	140	1	22,00	455300.A400
G	400	ASY	3000	64.400	56.000	140	1	22,00	455400.A300
G	400	ASY	4000	64.400	56.000	140	1	22,00	455400.A400
DALI 2	G	275	ASY	3000	44.200	38.500	1	22,00	555300.A300
DALI 2	G	275	ASY	4000	44.200	38.500	1	22,00	555300.A400
DALI 2	G	400	ASY	3000	64.400	56.000	1	22,00	555400.A300
DALI 2	G	400	ASY	4000	64.400	56.000	1	22,00	555400.A400

LED Extreme 300 - 575 - 700 - ASY

Dettagli - Details



Dissipatori di calore in alluminio con altissimo potere dissipante.
Heat sink made by anodized aluminium with very high dissipating power



Dispositivo anticondensa: valvola di compensazione e riciclo dell'aria.
Anti-condensate device: valve for compensation and circulation of air.

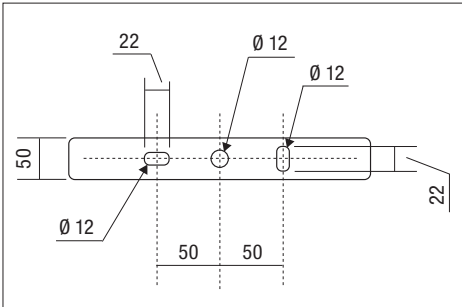

Staffa di fissaggio
Mounting bracket



Completo di connettore IP68 per una rapida installazione
Complete with IP68 connector for quick installation

Struttura in lega di alluminio verniciata a polveri epossidiche
Aluminum alloy structure coated with epoxy powder

Piastra posteriore in alluminio anodizzato
Natural anodized aluminum back plate

Riflettori in policarbonato
Polycarbonate reflectors

Staffa di aggancio regolabile con fissaggio meccanico e indicatore graduato
Adjustable hooking bracket with mechanical fasteners and graduated indicator

Vano di alimentazione protetto con guarnizioni siliconiche e pressacavo IP68
Protected power supply compartment with silicone gaskets and IP68 cable gland



LED **SAMSUNG**

Schermo di protezione in vetro borosilicato trasparente extra-chiaro
Extra clear protection screen made of borosilicate glass

Dispositivo di protezione contro fulmini e sovra correnti/tensioni (a richiesta)
Over current/tension and lighting protection device (on demand)

LED Driver **PHILIPS** **DALI 2**

LED Driver Philips Xitanium completamente programmabili. Funzioni opzionali abilitabili dall'utente tramite programmatore (NON fornito).
- Interfaccia di controllo: AmpDim
- Dimmerazione autonoma tramite DynaDimmer integrato
- Protezione termica per LED Driver (DLT)
- Uscita luce costante (CLO)
- Uscita luce regolabile (ALO)

Fully programmable Philips Xitanium LED Driver. Optional functions that can be enable by the user, through a programmer (NOT supplied)
- Control interface: AmpDim
- Autonomous dimming via integrated DynaDimmer
- Thermal protection for LED Driver (DLT)
- Constant lighting output (CLO)
- Adjustable light output (ALO)

Compreso di connettore IP68 5 poli (maschio montato sul prodotto e femmina a corredo)
With the lamp is including a 5 pole connector IP68 (male mounted on product and female included)

LED Extreme 300 - 575 - 700 - ASY

Accessori non inclusi - *Not included accessories*



Cod. 703952.NEW

Attacco palo per l'installazione di 1 proiettore, Ø 60/76 mm. In ferro verniciato con polveri termoindurenti poliesteri resistenti alla corrosione ed agli agenti atmosferici.

Pole attachment for the installation of 1 projector, size Ø 60/76 mm. Iron coated with polyester thermosetting powder coating, offering high resistance to rust and external atmospheric agents.



Cod. 800011.0101

Griglia di protezione
Protection grid



A richiesta: verniciatura resistente a 2.000 ore di esposizione alla nebbia salina in accordo alla norma ISO 9227 certificato da Ente esterno.

On request: painting resistant to 2,000 hours of exposure to salt spray in accordance with ISO 9227 certified by an external body.

Aqaba Football Field stadium, Giordania



Quando guardiamo una trasmissione televisiva, può capitare di notare un fastidioso sfarfallio durante la riproduzione delle immagini a rallentatore. Il fenomeno, detto anche "flicker", affatica la vista e distrae il telespettatore soprattutto durante le riprese a "moviola". Le cause dello sfarfallio possono variare in base alla frequenza della modulazione, la fluttuazione di tensione ed il numero di fotogrammi al secondo. Generalmente uno sfarfallio inferiore al 5% non da alcun fastidio durante le riprese a "moviola" fino a 150 fotogrammi al secondo. Un sistema di illuminazione con un fattore di sfarfallio (FF) inferiore a 5% è in grado di eliminare lo sfarfallio percepito in quasi tutte le frequenze dei fotogrammi utilizzate nelle riprese sportive.

During a broadcast it is not uncommon to perceive an annoying flicker especially during slow motion. This flicker is distracting and should be eliminated where possible. The circumstances that produce the flicker vary upon the frequency modulation, voltage and camera frame rate. The table below provides a general rule of flicker factor values produced by various lighting systems. A flicker factor of less than 5% will generally not cause problems for slow motion replays at up to 150 frames per second. A lighting system with a flicker factor of less than 5% will eliminate the perceived flicker at most frame rates per second used within the sports television industry. The acceptable level of flicker factor (FF) is indicated in the Illuminace Category Tables.

LED Jaguaro

Gamma completa di proiettori da esterno ideale per illuminare parcheggi, piazzali, facciate, zone carico-scarico e grandi aree in generale.

Installazione: a palo o a parete.

Corpo e telaio: in alluminio pressofuso UNI EN 1706 verniciato con polvere termoindurente poliestere.

Staffa di fissaggio: in acciaio, verniciata con polvere termoindurente poliestere, con goniometro graduato per un corretto puntamento del fascio luminoso.

Verniciatura: di tipo poliestere eseguita a polvere, resistente agli agenti atmosferici, alla corrosione. Nero RAL 9005.

Ottica: semi concentrante, intermedia e semi-diffondente in PMMA con resistenza alle alte temperature, agli shock termici e agli urti

Rischio fotobiologico: IEC 62471 - rischio esente

Schermo: vetro temprato trasparente di spessore 4mm resistente agli shock termici e agli urti.

Sorgente: LED SMD 5050 **SAMSUNG**
Mantenimento del flusso luminoso (L80-B20 > 50.000h).

Temperatura di colore: 4000K; altre temperature di colore a richiesta (2200K - 2700K - 3000K - 5000K
Consegna 60 giorni).

Driver: incorporato 
Fattore di potenza $\geq 0,95$.

Protezione alle sovratensioni inclusa:

Modo differenziale 5kV (L-N)

Modo comune 10kV (L-GND, N-GND, L&N-GND)

Protezione: 5/10kV

Norme di riferimento: IEC 61000-4-5; EN60598-1; EN60598-2-1; EN62471; EN62031; EN60598-2-5; EN61547

Complete range of outdoor projectors perfect to light up car parks, squares, facades, loading and unloading areas and large areas in general.

Installation: on pole or wall

Housing and frame: made by UNI EN 1706 die-cast aluminum, coated with polyester thermoset powder.

Fixing bracket: made by stainless steel, coated with polyester thermoset powder, with graduated goniometer to allow the correct orientation of light beam

Coating: coated with powdered polyester, resistant to atmospheric agents and corrosion. RAL 9005 Black.

Optic: spot, medium and flood.

Eyesafety: IEC 62471 - risk exempt

Shield: transparente tempered glass with 4mm thickness resistant to thermal shocks and collisions

Light source: LED SMD 5050 **SAMSUNG**
Maintenance of minimum luminous flux (L80-B20 > 50.000h).

Color temperature: 4000K; other color temperatures available on demand (2200K - 2700K - 3000K - 5000K.
Delivery time: 60 days)

Driver: included 
Power factor $\geq 0,95$

Protection: 5/10kV

Standard reference: IEC 61000-4-5; EN60598-1; EN60598-2-1; EN62471; EN62031; EN60598-2-5; EN61547

La certificazione fotometrica dei nostri apparecchi viene sempre effettuata da un istituto esterno. Efficienza luminosa e "lm Output" sono quindi il risultato di tale istituto.

The photometric certification of our appliances is always carried out by an external institute. Luminous efficiency and "lm Output" are therefore the result of this institute.

A richiesta - On demand



Wireless

DMX

Vedi Pag. VI - See page VI

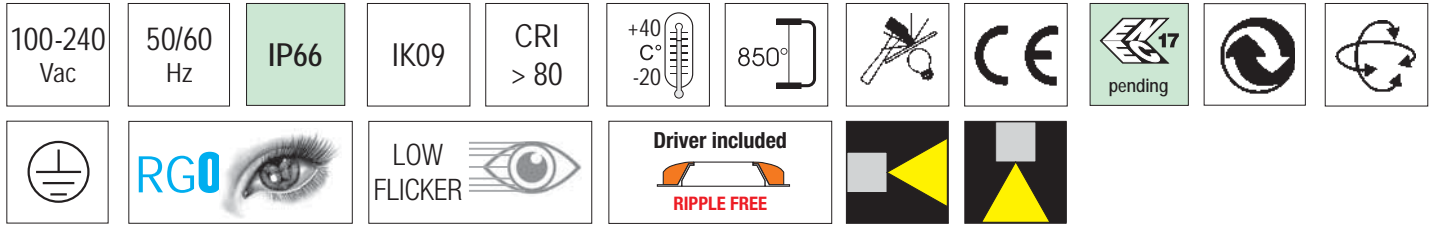

LED Jaguaro 1

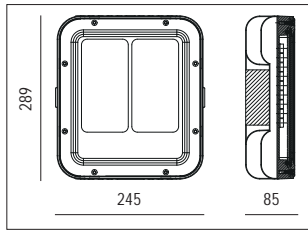

colour	W	angle	K	nominal lm tc = 25°C	lm output	lm/W	pcs	Kg	CELL
N	120	ASY 1	4000	17.250	15.000	125	1	4,50	29700-120
N	120	35°	4000	17.250	15.000	125	1	4,50	29701-120
N	120	90°	4000	17.250	15.000	125	1	4,50	29702-120
N	160	ASY 1	4000	22.600	20.000	125	1	4,50	29700
N	160	35°	4000	22.600	20.000	125	1	4,50	29701-5K
N	160	35°	5000	22.600	20.000	125	1	4,50	29701
N	160	90°	4000	22.600	20.000	125	1	4,50	29702
N	180	ASY 1	4000	25.800	22.500	125	1	4,50	29700-180
N	180	35°	4000	25.800	22.500	125	1	4,50	29701-180
N	180	90°	4000	25.800	22.500	125	1	4,50	29702-180

LED Jaguaro 2

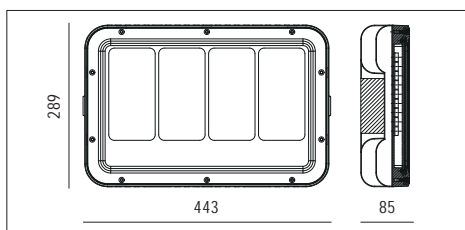
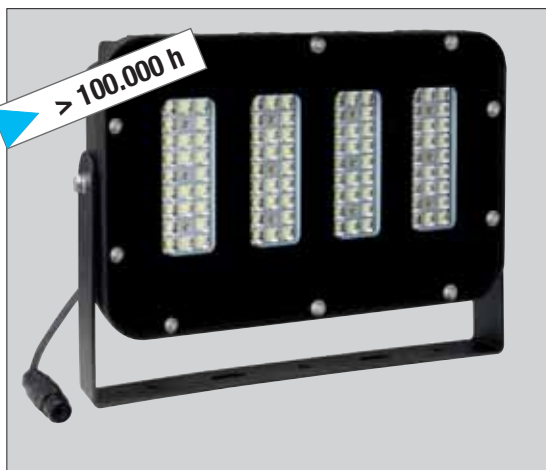

colour	W	angle	K	nominal lm tc = 25°C	lm output	lm/W	pcs	Kg	CELL
N	220	ASY 1	4000	31.000	27.500	125	1	9,00	29710
N	220	35°	4000	31.000	27.500	125	1	9,00	29711
N	220	90°	4000	31.000	27.500	125	1	9,00	29712
N	320	ASY 1	4000	45.200	40.000	125	1	9,00	29713
N	320	35°	4000	45.200	40.000	125	1	9,00	29714
N	320	90°	4000	45.200	40.000	125	1	9,00	29715
N	400	ASY 1	4000	55.200	48.000	120	1	10,00	29713-400
N	400	35°	4000	55.200	48.000	120	1	10,00	29714-400
N	400	90°	4000	55.200	48.000	120	1	10,00	29715-400
N	400	35°	5000	55.200	48.000	120	1	10,00	29714-400-5K
N	220	ASY 1	5000	31.000	27.500	125	1	9,00	29710-5K
N	220	35°	5000	31.000	27.500	125	1	9,00	29711-5K
N	220	90°	5000	31.000	27.500	125	1	9,00	29712-5K
N	320	ASY 1	5000	45.200	40.000	125	1	9,00	29713-5K
N	320	35°	5000	45.200	40.000	125	1	9,00	29714-5K
N	320	90°	5000	45.200	40.000	125	1	9,00	29715-5K

LED Jaguaro



Il sistema di dissipazione del calore è realizzato per garantire un perfetto funzionamento dei LED e di conseguenza un'elevata durata di vita.

The heat dissipation system is designed to ensure perfect operation of the LEDs and consequently a long lifespan.institute.

Ottiche standard - Standard optics

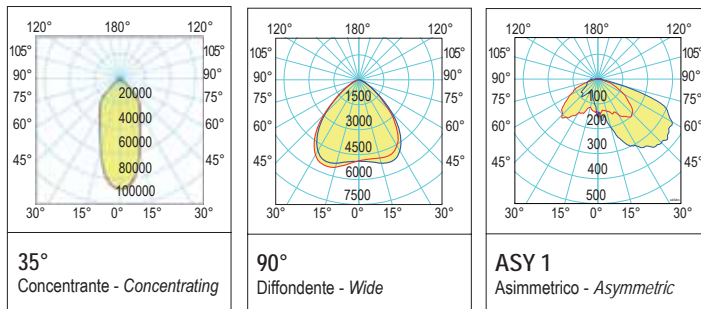

Ottiche a richiesta - On demand optics

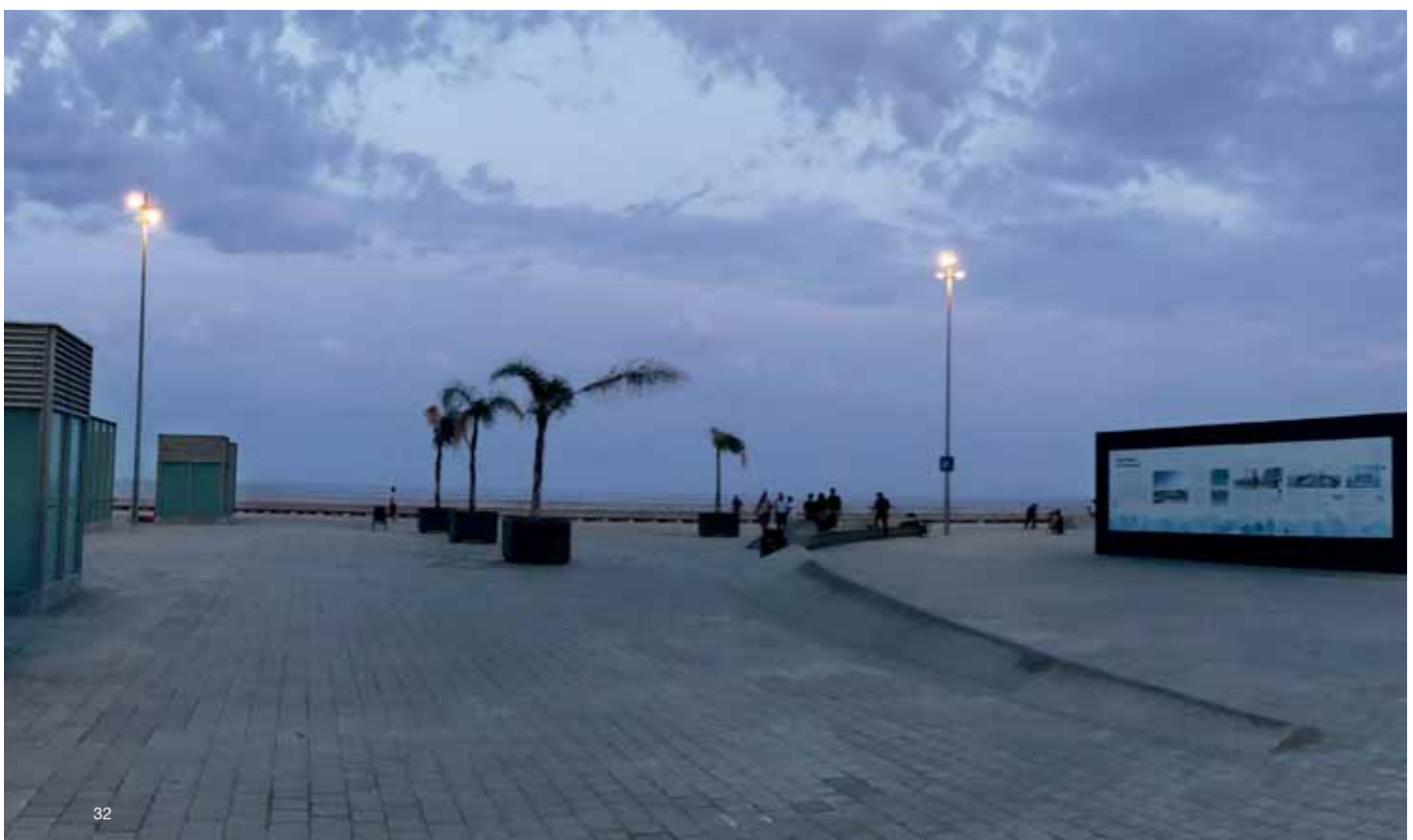
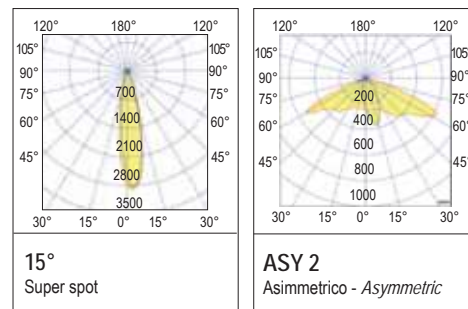











LED Jaguaro



Floodlight

SMART - Torre Faro - Light Tower

 max height 2 m	 Kg 108	 rotation 340°	 ZERO noise	 100% BATTERY first unique battery driven	 RUNNING TIME 8 H
 750 sqm illuminated area	 VERY COMPACT dimensions for easy handling & transportability	 Leader in sustainability	 54 units per truck		

2x70W LED - 2m

- Proiettori orientabili in più direzioni
- Montante verticale telescopico zincato a 1 sezione
- Altezza massima del palo 2 m
- Sistema di sollevamento manuale
- Verniciatura a polvere da 80 µm
- Dimensioni molto compatte per una facile movimentazione e trasportabilità, fino a 54 unità per camion
- Occhio di sollevamento centrale per una movimentazione efficace
- Carrello a mano
- Peso leggero per una migliore manovrabilità
- Design e layout della macchina semplici e robusti
- Cavo elettrico protetto per evitare danni durante il funzionamento della torre
- Interruttori acceso/spento
- Facile accesso per la manutenzione
- 2 stabilizzatori zincati estensibili e regolabili in altezza
- Pacco batterie in TECNOLOGIA AGM
- Caricabatteria incorporato

- Multi-directionally adjustable and tiltable floodlights
- 1 section galvanized telescopic vertical mast
- Maximum mast height 2 m
- Manual lifting system
- 80 µm powder coating
- Very compact dimensions for easy handling and transportability, up to 54 units per truck
- Central lifting eye for effective handling
- Hand trolley
- Light weight for improved manoeuvrability
- Simple, rugged machine design and layout
- Protected electrical cable to avoid damage during tower operation
- On/Off switches
- Easy access for maintenance
- 2 extendable & height adjustable galvanized stabilizers
- Battery pack in AGM TECHNOLOGY
- Built-in battery recharger



Dimensioni e peso <i>Dimensions and weight</i>	Dimensioni min (mm) <i>Dimensions min (mm)</i>		Dimensioni max (mm) <i>Dimensions max (mm)</i>		Peso totale (Kg) <i>Total weight (Kg)</i>		
		598x648x1650 (LxWxH)		1000x664x2000 (LxWxH)		108	
Proiettori <i>Floodlight</i>	Tipo - Type	Potenza Power	N° proiettori N° floodlight	Grado IP - IP level	Area illuminata (mq²) Illuminated area (sqm)	Tempo di ricarica con proiettore spento Charging time with floodlight off	
	LED	70W	2	65	750	± 10 h	
Mast	Metodo di sollevamento Lifting method		Altezza massima Max height		Velocità massima del vento Max wind speed		Rotazione Rotation
	Manuale - Manual		2 m		30 Km/h		340°
Batteria <i>Battery</i>	Tipo Type	N° batterie N° battery	Potenza pacco batteria Power battery pack	Tempo di esecuzione Running time	Caricabatterie Battery charger	Ciclo batteria previsto Expected battery cycle	Durata batteria previsto Expected battery life
	AGM	1	12Vdc - 100Ah	8 h	230V - 1Ph Built in	500 h	400 h

CLEVER - Torre Faro - Light Tower

 max height	 kg	 rotation 340°	 EASY handling & transportability	 ZERO emissions	 ZERO fuel costs	 ZERO noise	 MINIMAL service
			 EASY handling & transportability	 2600 sqm illuminated area	 LINKABLE TOWERS	 Complete SILENCE on work time 8 HOURS A DAY 7 DAYS A WEEK	

2x160W LED - 7m

- Proiettori orientabili in più direzioni
- Torre verticale a 5 sezioni da 7 metri, ruotabile di 340°
- Sistema di sollevamento manuale ad argano completo di sistema autofrenante
- Carpenteria zincata
Verniciatura a polvere da 80 µm
- Dimensioni molto compatte per una facile movimentazione e trasportabilità, fino a 33 unità per camion
- Peso leggero per una migliore manovrabilità
- Tasche per carrello elevatore con occhiello di sollevamento centrale per una movimentazione efficace
- Cavo a spirale principale guidato per evitare danni durante il funzionamento della torre
- Interruttore automatico per la protezione elettrica contro il sovraccarico
- Stabilità al vento certificata fino a 110 km/h
- 4 stabilizzatori estensibili e regolabili in altezza
- Livelli a bordo per la guida durante la stabilizzazione
- Freno di emergenza dell'albero brevettato che impedisce la caduta dell'albero nel caso di guasto del cavo
- Copertura del verricello
- Coperchio di protezione superiore della scatola elettrica
- 2 maniglie zincate a scomparsa
- Sensore di luminosità di serie
- Occhiello di sollevamento centrale imbullonato

- Multi-directionally adjustable and tiltable floodlights
- 5 sections vertical tower 7meters, 340° rotatable
- Manual lifting system by winch complete with auto-braking system
- Galvanized metalworks
- 80 µm powder coating
- Very compact dimensions for easy handling & transportability, up to 33 units per truck
- Light weight for improved manoeuvrability
- Central lifting eye forklift pockets for effective handling
- Guided main coiled cable to avoid damage during tower operation
- Circuit breaker for electrical protection against overload
- Certified wind stability up to 110 km/h
- 4 extendable & height adjustable stabilizers
- On board levels for guidance during stabilization
- Patented mast emergency brake which prevents the falling of the mast in case of cable failure
- Winch cover
- Top electrical box protection cover
- 2 Retractable galvanized handles
- Light Sensor as standard feature
- Bolted Central lifting eye







Floodlight





Dimensioni e peso Dimensions and weight	Dimensioni min (mm) Dimensions min (mm)		Dimensioni max (mm) Dimensions max (mm)		Peso totale (Kg) Total weight (Kg)		
		1200x850x2100 (LxWxH)		1850x1450x7000 (LxWxH)		300	
Proiettori Floodlight	Tipo - Type	Potenza Power	N° proiettori N° floodlight	Grado IP IP level	Area illuminata (mq²) Illuminated area (sqm)		
	LED	160W	4	65	2600		
Mast	Metodo di sollevamento Lifting method		Altezza massima Max height		Velocità massima del vento Max wind speed	Rotazione Rotation	Sistema di emergenza dell'albero brevettato Patented mast emergency system
	Manuale - Manual		7 m		110 Km/h	340°	SI - YES
Entrata e uscita Input and output	Spina di ingresso Inlet plug	Presse corrente Outlet socket	Generali General	Metodo di sollevamento della torre Tower lifting method		Tipo di rimorchio Trailer type	
	32A - 230V	32A - 230V		Manuale - Manual		Carrello a mano - Hand trolley	

Torre Faro - Light Tower

UTILITY - 4x160W LED - 8m

 max height 8 m	 Kg 680	 rotation 340°	 Fuell tank 80L-0,55L/K
--	---	---	--

UTILITY PLUS - 4x320W LED - 8m

 max height 8 m	 Kg 706	 rotation 340°	 Fuell tank 80L-0,55L/K
--	---	---	--



- Proiettori orientabili in più direzioni
- Torre verticale a 7 sezioni 8 m, ruotabile di 340°
- Carpenteria zincata
- Verniciatura a polvere da 80 µm
- Occhiello di sollevamento centrale, tasche per carrello elevatore per una movimentazione efficace
- Plug & play, cavi e connettori codificati a colori
- Cavo a spirale principale guidato per evitare danni durante il funzionamento della torre
- Allarmi quadro comandi per protezione motore e indicatore livello carburante
- Interruttore automatico per la protezione elettrica contro il sovraccarico
- Pulsante di arresto di emergenza esterno
- Stabilità al vento certificata fino a 80 km/h
- 5 stabilizzatori regolabili in altezza
- Livelli a bordo per la guida durante la stabilizzazione











- Multi-directionally adjustable and tiltable floodlights
- 7 sections vertical tower 8 m, 340° rotatable
- Galvanized metalworks
- 80 µm powder coating
- Central lifting eye, forklift pockets for effective handling
- Plug & play, colour coded cables and connectors
- Guided main coiled cable to avoid damage during tower operation
- Control panel alarms for engine protection and fuel level indicator
- Circuit breaker for electrical protection against overload
- External emergency stop button
- Certified wind stability up to 80 km/h
- 5 height adjustable stabilizers
- On board levels for guidance during stabilization

4x160 3300 sqm illuminated area	4x320 5000 sqm illuminated area	Cost Effective	RUNNING TIME 80 litres tank 145 h	NOISE level 65 dB(A) at 7m	18 units per truck
--	--	-----------------------	--	--------------------------------------	---------------------------

Dimensioni e peso Dimensions and weight	Dimensioni min (mm) Dimensions min (mm)		Dimensioni max (mm) Dimensions max (mm)		Peso totale (Kg) 4x160W Total weight (Kg)	Peso totale (Kg) - 4x320W Total weight (Kg)	
		1830x1370x2560 (LxWxH)		2320x2570x8000 (LxWxH)		680	706
Proiettori Floodlight	Tipo - Type		N° proiettori N° floodlight		Area illuminata (mq²) 4x160 Illuminated area (sqm)	Area illuminata (mq²) - 4x320 Illuminated area (sqm)	
	LED	160W - 320W	4		3300	5000	
Mast	Metodo di sollevamento Lifting method		Altezza massima Max height		Velocità massima del vento Max wind speed	Rotazione Rotation	Opzioni Option
	Manuale - Manual		8 m		80 Km/h	340°	Rimorchio stradale omologato Homologated road trailer
Alternatore Alternator	Modello Model	Frequenza (Hz) Frequency (Hz)	Classe energetica Insulation class	Grado IP IP level	Tensione monofase Single phase voltage		Uscita ausiliaria Auxiliary outlet
	Sincrono Synchronous	50	H	23	3,5kVA - 230V		1 kVA
Motore Engine	Modello Model	Carburante Fuel	r.p.m	Capacità serbatoio (l) Tank capacity (l)	Consumo (l/h) Consumption (l/h)	Tempo di esecuzione Running time	Rumorosità dB(A) a 7m Noise level dB (A) at 7m
	Kubota Z482*	Diesel	1500	80	0,55	145 h	65

* Può variare in base alla disponibilità di magazzino. Tuttavia, alla fine verrà utilizzato il marchio equivalente primario Yanmar
May vary based on stock availability. However, Yanmar primary equivalent brand eventually will be used

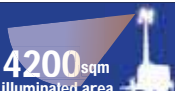
POWER - Torre Faro - Light Tower

 max height 8,5 m	 Kg 920	 rotation 340°	 Fuell tank 110L-0,55L/h	 45% reduced transport costs	 45% Reduction in Yard Space	 RUNNING TIME 110 litres tank 200 h fuel consumption 0,55 l/h	 NOISE level 65 dB(A) at 7m
 4200 ^{sqm} illuminated area				 14 units per truck			

6x160W LED - 8m

- Proiettori orientabili in più direzioni
- Luci LED 6x160W, 48V
- Alimentazione 48V tra il generatore e le luci
- Torre verticale idraulica a 7 sezioni 8,5 m, ruotabile di 340°
- Carpenteria zincata
- Verniciatura a polvere da 80 µm
- Dimensioni molto compatte, fino a 14 unità per camion
- Occhiello di sollevamento centrale, tasche per carrello elevatore longitudinali e trasversali per una movimentazione efficace
- Plug & play, cavi e connettori codificati a colori
- Grado di protezione certificato IP67
- Cavo a spirale principale guidato per evitare danni durante il funzionamento della torre
- Pannello di controllo digitale e indicatore livello carburante
- Interruttore automatico per la protezione elettrica contro il sovraccarico
- Pulsante di arresto di emergenza esterno
- Serbatoio completamente raggruppato, 110%
- Stabilità al vento certificata fino a 110 km/h
- 4 stabilizzatori regolabili in altezza
- Livelli a bordo per la guida durante la stabilizzazione
- Interruzione di sicurezza di Amoss

- Multi-directionally adjustable and tiltable floodlights
- 6x160W, 48V LED lights
- 48V power between the generator and the lights
- 7 sections hydraulic vertical tower 8,5 m, 340° rotatable
- Galvanized metalworks
- 80 µm powder coating
- Very compact dimensions, up to 14 units per truck
- Central lifting eye, longitudinal and transversal forklift pockets for effective handling
- Plug & play, colour coded cables and connectors
- IP67 level protection certified
- Guided main coiled cable to avoid damage during tower operation
- Digital control panel and fuel level indicator
- Circuit breaker for electrical protection against overload
- External emergency stop button
- Fully bunded tank, 110%
- Certified wind stability up to 110 km/h
- 4 height adjustable stabilizers
- On board levels for guidance during stabilization
- Amoss safety break



Floodlight

Dimensioni e peso <i>Dimensions and weight</i>	Dimensioni min (mm) <i>Dimensions min (mm)</i>		Dimensioni max (mm) <i>Dimensions max (mm)</i>		Peso totale (Kg) <i>Total weight (Kg)</i>		
		2540x1390x2420 (LxWxH)		2540x1550x8500 (LxWxH)		920	
Proiettori <i>Floodlight</i>	Tipo - Type	Potenza Power	N° proiettori N° floodlight	Opzioni Option	Area illuminata (mq²) Illuminated area (sqm)		
	LED	160W	6	Timer	4200		
Mast	Metodo di sollevamento Lifting method		Altezza massima Max height		Velocità massima del vento Max wind speed		Rotazione Rotation
	Idraulico - Hydraulic		8,5 m		110 Km/h		340°
Alternatore <i>Alternator</i>	Modello Model		Frequenza (Hz) Frequency (Hz)	Classe energetica Insulation class	Grado IP IP level	Tensione monofase Single phase voltage	Uscita ausiliaria Auxiliary outlet
	Sincrono - Synchronus		50	H	23	3,5kVA - 230V	1,2 kVA
Motore <i>Engine</i>	Modello Model	Carburante Fuel	r.p.m	Capacità serbatoio (l) Tank capacity (l)	Consumo (l/h) Consumption (l/h)	Tempo di esecuzione Running time	Rumorosità dB(A) a 7m Noise level dB (A) at 7m
	Kubota Z482*	Diesel	1500	110	0,55	200 h	65

POWER vs STANDARD	Consumo di carburante Fuel usage	Costo del carburante al mese Fuel cost per month	Emissioni CO2 al mese CO2 Emission month	Tempo di funzionamento sul serbatoio del carburante Run time on fuel tank	Tipo di lampada Lamp type	Sensore di luce Light sensor	Kit Amos Amoss Kit
Torre faro standard Standard lighting tower	1,93 l/h	€ 550,00	1.224 Kg	60 h	Ioduri metallici Metal halide	Optional	Optional
POTENZA torre faro POWER lighting tower	0,55 l/h	€ 150,00	336 Kg	200 h	LED	Standard	Standard
Risparmi mensili quando si utilizza la torre faro POWER Mountly savings when using POWER light tower	1,38 l/h	€ 400,00	888 Kg	140 h	-	-	-

* Può variare in base alla disponibilità di magazzino. Tuttavia, alla fine verrà utilizzato il marchio equivalente primario Yanmar
May vary based on stock availability. However, Yanmar primary equivalent brand eventually will be used

LED Minizeus - LED Zeus



La certificazione fotometrica dei nostri apparecchi viene sempre effettuata da un istituto esterno. Efficienza luminosa e "Im Output" sono quindi il risultato di tale istituto.

The photometric certification of our appliances is always carried out by an external institute. Luminous efficiency and "Im Output" are therefore the result of this institute.

A richiesta - On demand

Sensor DIM
1-10V

Sensor DIM
DALI

DALI 2

Wireless

Vedi Pag. VI - See page VI

Gamma completa di proiettori da esterno ed interno ideale per illuminare parcheggi, piazzali, facciate, zone carico-scarico, centri commerciali e grandi aree in generale.

Installazione: a parete e a sospensione.

Corpo e telaio: in alluminio pressofuso UNI EN 1706.

Staffa di fissaggio: in metallo, verniciata con polvere termoindurente poliestere, con goniometro graduato per un corretto puntamento del fascio luminoso.

Verniciatura: di tipo poliestere eseguita a polvere, resistente agli agenti atmosferici, alla corrosione e alla nebbia salina. Grigio RAL 9007.

Ottica: concentrante, semi concentrante, diffondente, asimmetrica ed ellittica. In PMMA con resistenza alle alte temperature, agli shock termici e agli urti

Schermo: vetro temprato di spessore 4mm resistente agli shock termici e agli urti.

Sorgente: LED **SAMSUNG**

Mantenimento del flusso luminoso minimo al 90% - 100.000h (L90B10) per il 90% dei LED.

Temperatura di colore: 4000K; altre temperature di colore a richiesta (2200K - 2700K - 3000K - 5000K - Consegna: 60 giorni).

Driver: incorporato

Fattore di potenza $\geq 0,95$.

Protezione alle sovratensioni inclusa:

Modo differenziale 6kV (L-N)

Modo comune 8kV (L-GND, N-GND, L&N-GND)

A richiesta: versione con protezione maggiorata (10kV) contro gli impulsi aggiungendo il cod. RO0640/N (di serie in LED ZEUS).

Norme di riferimento: EN60598-1; EN60598-2-1; EN62471; EN62031; EN60598-2-5; EN61547

LED Zeus 250W: 110-240V

Complete range of outdoor and indoor projectors perfect to light up car parks, squares, facades, loading and unloading areas, shopping centers and large areas in general.

Installation: on the wall and suspended.

Housing and frame: made by UNI EN 1706 die-cast aluminum.

Fixing bracket: made by metal, coated with polyester thermoset powder, with graduated goniometer to allow the correct orientation of light beam

Coating: coated with powdered polyester, resistant to atmospheric agents and corrosion and guaranteed in saline mist. RAL 9007 Grey.

Optic: clumping, semi-clumping, wired asymmetric and elliptical. PMMA optic with high temperature resistance, thermal shock and impact resistance

Shield: tempered glass with 4mm thickness resistant to thermal shocks and collisions.

Light source: LED **SAMSUNG**

Maintenance of minimum luminous flux to 90% - 100.000h (L90B10) for 90% of LED.

Color temperature: 4000K; other color temperatures available on demand (2200K - 2700K - 3000K - 5000K - Delivery time: 60 days).

Driver: included

Power factor $\geq 0,95$

Protection against overvoltages included:

Differential mode 6kV (L-N)

Standard mode 8kV (L - GND, N-GND, L&N-GND).

On demand: this version with greater protection (10kV) with code RO0640/N (Of series in LED Zeus).

Standard reference: EN60598-1; EN60598-2-1; EN62471; EN62031; EN60598-2-5; EN61547

LED Zeus 250W: 110-240V

LED Minizeus - LED Zeus



A richiesta: versione conforme alla direttiva HACCP per gli impianti illuminotecnici nelle industrie alimentari

On demand: HACCP directive for lighting systems in food industries version



Floodlight

220-240 Vac	110 Vac On demand	50/60 Hz	IP66	IK09	CRI > 80	+40 C -25	850°		CE		
	RG0	LOW FLICKER	Driver included MULTIPOWER RIPPLE FREE		TECEE						

LED Minizeus

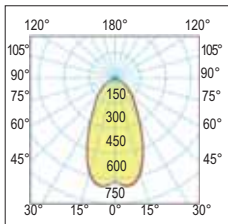
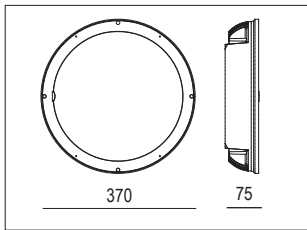

50°
Intermedio - Medium

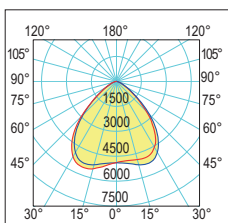

90°
Diffondente - Wide

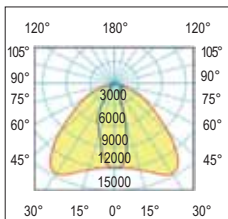

ELLIP
Ellittica - Elliptical

colour	W	angle	K	nominal lm tc = 25°C	lm output	lm/W	pcs	Kg	CELL
G	75	50°	4000	10.600	9.380	125	1	4,50	354087.75
G	110	50°	4000	17.400	15.400	125	1	4,50	354087.100
G	150	50°	4000	21.200	18.750	125	1	4,50	354087.150
G	150	50°	3000	21.200	18.750	125	1	4,50	354087.1503
G	200	50°	4000	31.600	28.000	140	1	4,50	354087.200
G	75	90°	4000	10.600	9.380	125	1	4,50	354096.75
G	110	90°	4000	17.400	15.400	125	1	4,50	354096.100
G	150	90°	4000	21.200	18.750	125	1	4,50	354096.150
G	150	90°	3000	21.200	18.750	125	1	4,50	354096.1503
G	200	90°	4000	31.600	28.000	140	1	4,50	354096.200
G	200	90°	3000	31.600	28.000	140	1	4,50	354096.2003K

-
-
-
-
-
-
-
-
-
-

colour	W	angle	K	nominal lm tc = 25°C	lm output	lm/W	pcs	Kg	CELL
G	75	50°	4000	10.600	9.380	125	1	4,50	354087.75D
G	110	50°	4000	17.400	15.400	125	1	4,50	354087.100D
G	110	50°	4000	17.400	15.400	125	1	4,50	354087.100DAEM
G	150	50°	4000	21.200	18.750	125	1	4,50	354087.150D
G	200	50°	4000	31.600	28.000	140	1	4,50	354087.200D
G	75	90°	4000	10.600	9.380	125	1	4,50	354096.75D
G	110	90°	4000	17.400	15.400	125	1	4,50	354096.100D
G	150	90°	4000	21.200	18.750	125	1	4,50	HE4096.150D
G	200	90°	4000	31.600	28.000	140	1	4,50	354096.200D
G	200	90°	3000	31.600	28.000	140	1	4,50	354096.200D3K

colour	W	angle	K	nominal lm tc = 25°C	lm output	lm/W	pcs	Kg	CELL
G	75	ELLIP	4000	10.600	9.380	125	1	4,50	354029.75E
G	110	ELLIP	4000	17.400	15.400	125	1	4,50	354029.100E
G	150	ELLIP	4000	21.200	18.750	125	1	4,50	HE4029.150E
G	75	ELLIP	4000	10.600	9.380	125	1	4,50	354029.75ED
G	110	ELLIP	4000	17.400	15.400	125	1	4,50	354029.100ED
G	150	ELLIP	4000	21.200	18.750	125	1	4,50	HE4029.150ED

LED Minizeus: Accessori non inclusi - *Not included accessories*

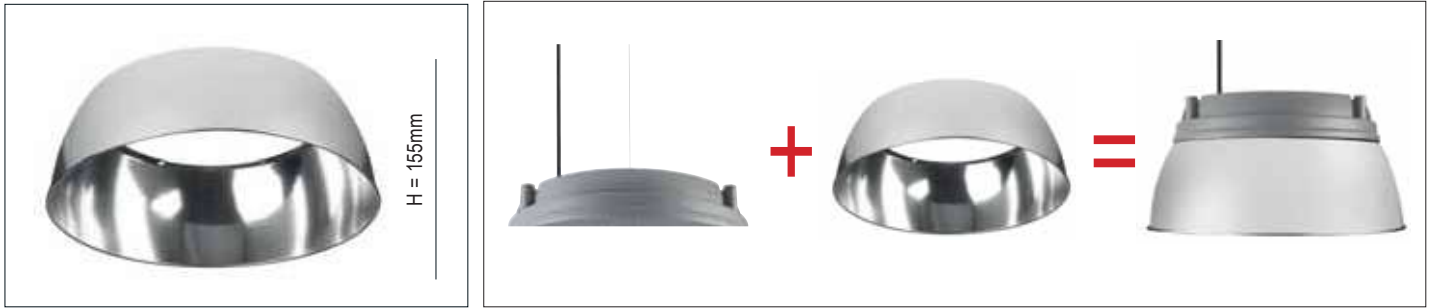

Cod: RF-60100
Riflettore in alluminio compreso di 4 viti 51804500 - *Aluminum reflector including 4 screws 51804500*



Floodlight

220-240 Vac	110 Vac On demand	50/60 Hz	IP66	IK09	CRI > 80	+40 C -25	850°		CE		
	RG0	LOW FLICKER	Driver included MULTIPOWER RIPPLE FREE		TECEE						

LED Zeus

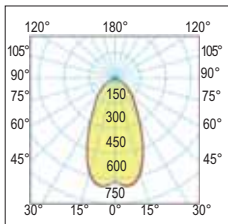
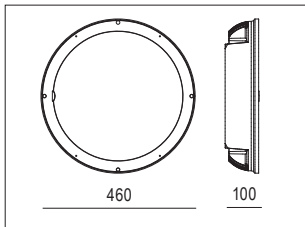

50° - Intermedio - Medium

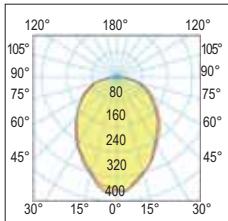

90° - Diffondente - Wide

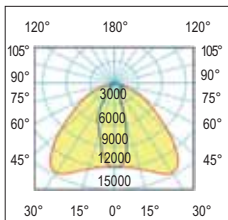

ELLIP
Ellittica - Elliptical

colour	W	angle	K	nominal Im tc = 25°C	Im output	lm/W	pcs	Kg	CELL
G	175	50°	4000	25.700	22.750	130	1	9,70	334087.185
G	175	90°	4000	25.700	22.750	130	1	9,70	334096.185
G	200	50°	4000	29.400	26.000	130	1	9,70	HE4087.210
G	250	50°	4000	36.700	32.500	130	1	9,70	HE4087.250
G	200	90°	4000	29.400	26.000	130	1	9,70	HE4096.210
G	250	90°	4000	36.700	32.500	130	1	9,70	HE4096.250
G	210	50°	4000	30.800	27.300	130	1	9,70	334087.210D
G	210	90°	4000	30.800	27.300	130	1	9,70	334096.210D

colour	W	angle	K	nominal Im tc = 25°C	Im output	lm/W	pcs	Kg	CELL
G	175	ELLIP	4000	25.700	22.750	130	1	9,70	334029.185E
G	200	ELLIP	4000	29.400	26.000	130	1	9,70	HE4029.210E
G	210	ELLIP	4000	30.800	27.300	130	1	9,70	334029210ED



LED Zeus - LED Minizeus

LED Minizeus - LED Zeus: Accessori non inclusi - *Not included accessories*

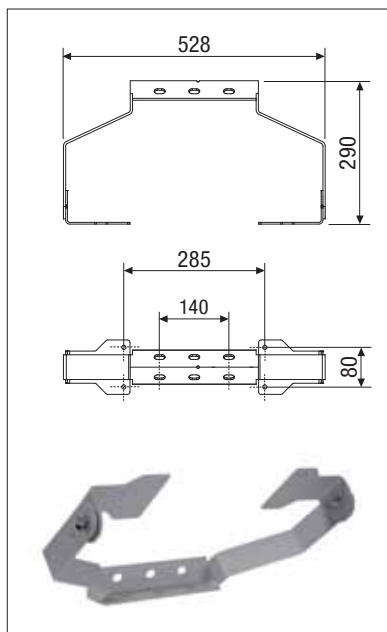

Code: 703959.0101

Staffa sagomata orientabile per montaggio a parete più goniometro per puntamento proiettore
Shaped adjustable bracket for wall mounting complete with protractor pointing to the projector

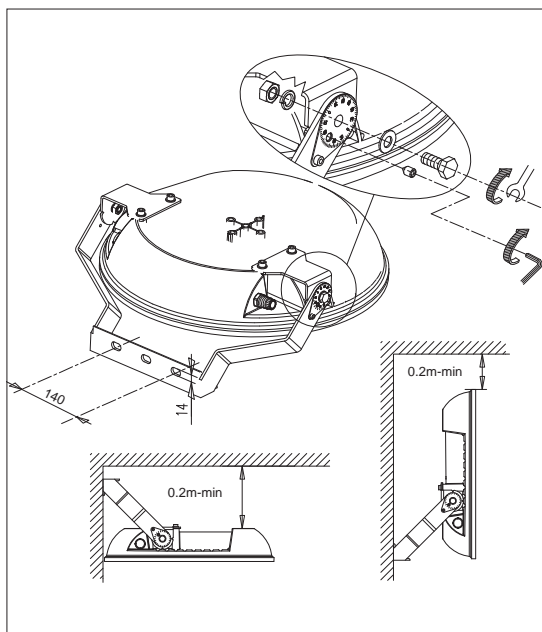

Code: 2020.001

Staffa orientabile per montaggio a parete
Shaped bracket for wall mounting

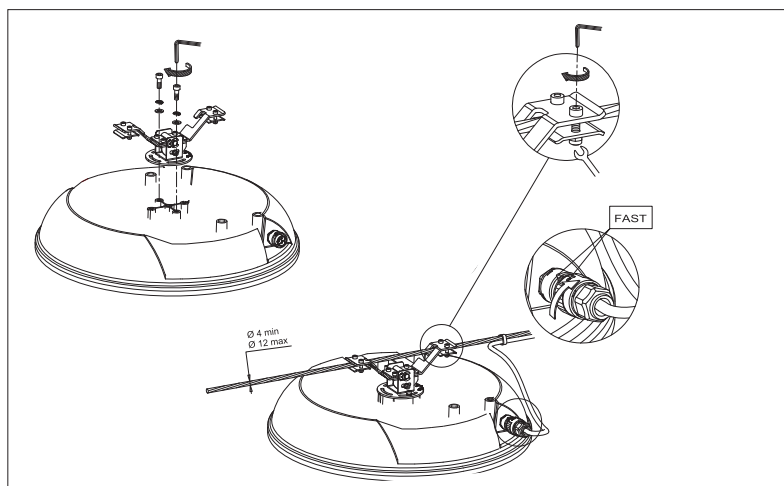

Code: 703960.0101 - Staffa a tesata - *Suspension mounting*



Cod: 703952.NEW

Attacco palo per 1 o 2 proiettori, Ø 60/76mm
Pole attachment for either 1 or 2 floodlights, size Ø 60/76mm

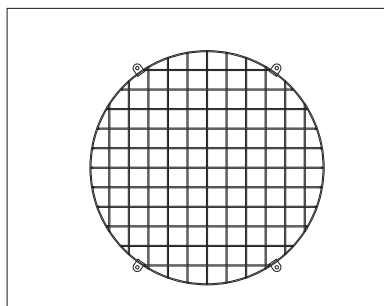

Cod: 800017.0101 - LED Minizeus
Griglia di protezione - *Protection grid*

Cod: 800016.0101 - LED Zeus
Griglia di protezione - *Protection grid*

Code: RO0640/N

PROTEZIONE ALLE SOVRATENSIONI (di serie in LED Zeus) SURGE PROTECTOR (of serie in LED zeus)

In un impianto elettrico standard un apparecchio a LED può essere sottoposto a sbalzi di tensione e disturbi esterni dovuti a fattori quali carichi discontinui sulla linea, guasti sulle linee a monte o a valle e, soprattutto, scariche atmosferiche (negli impianti esterni). Nei nostri proiettori, dove l'elettronica è fondamentale, la resistenza alle sovratensioni è sinonimo di affidabilità e corretta funzionalità.

In a standard electrical system an LED luminaire can be subjected to voltage fluctuations and external disturbances due to factors such as discontinuous loads on the line, faults on the lines upstream or downstream and, especially, atmospheric discharges (in External Plants). In our projectors, where electronics is very important, the surge resistance is synonymous with reliability and proper functionality.



Dispositivo di protezione conforme alla Norma EN 61547 contro i fenomeni impulsivi atto a proteggere il modulo LED e il relativo alimentatore: classe II fino a 10kV

Protection device in compliance with the EN 61547 standard to counteract the impulsive phenomena designed to protect the LED module and the relative power supply: class II protection up to 10kV

Sovratensioni

Le sovratensioni sono un rapido innalzamento della differenza di potenziale tra le diverse polarità (Fase o Neutro) e la Terra, in alcuni casi sono talmente elevate da superare la soglia di isolamento dei componenti elettronici causandone così il danneggiamento. Esistono anche casi di sovratensioni di entità inferiore, le quali non provocano un immediato guasto dei moduli LED o driver privi di protezione, ma se nel tempo si verificano ripetutamente possono provocare il deterioramento dei LED, di conseguenza, una durata ridotta. Nel caso di sovratensioni di elevata entità, come la caduta dei fulmini, provocano invece un guasto immediato dei moduli LED o dei driver. Le sovratensioni, di fatto, provocano degli impulsi di energia con correnti elevate sia nel driver che nei moduli LED.

Overvoltages

Overvoltages are a rapid rise in the potential difference between the different polarities (Phase or Neutral) and the Earth, in some cases they are so high as to exceed the isolation threshold of the electronic components, thus causing damage. There are also cases of minor overvoltages, which do not cause an immediate failure of the unprotected LED modules or drivers, but if they occur repeatedly over time they can cause deterioration of the LEDs, consequently a reduced life span. In the event of high voltage surges, such as lightning strikes, they cause immediate failure of the LED modules or drivers. The overvoltages, in fact, cause energy pulses with high currents in both the driver and the LED modules.

A richiesta: verniciatura resistente a 2.000 ore di esposizione alla nebbia salina in accordo alla norma ISO 9227 certificato da Ente esterno.



On request: painting resistant to 2,000 hours of exposure to salt spray in accordance with ISO 9227 certified by an external body.

LED Minizeus - LED Zeus

Soluzioni NON incluse per aumentare il risparmio energetico - *NOT included solutions to increase energy saving*

Sensor - Sensor

Luce solo all'occorrenza - *Light only when needed*

Rilevatore di movimento a microonde con crepuscolare per impostazione soglia minima Lux ambiente di intervento e con livello di stand-by impostabile (10-20-30%) con driver dimmerabili [0-10V]; questa tecnologia emette onde elettromagnetiche ad alta frequenza (5,8GHz) e riceve il loro eco, in questo modo è in grado di riconoscere una qualsiasi variazione data da un oggetto non rilevato nella precedente analisi e verrà dato il comando di ON. La trasmissione ad alta frequenza è <10mW e risulta essere 100 volte inferiore alle emissioni di un comune telefono cellulare o di un forno a microonde che emettono mediamente 1000mW.

Microwave motion detector with twilight with adjustable stand-by level for setting Lux threshold for the intervention environment and with settable stand-by level (10-20-30%) with dimmable [0-10V] driver; this technology it emits electromagnetic waves at a high frequency (5.8GHz) and receives their echoes. In this way, it can recognise any variation given by an object not detected in the previous analysis and the ON command will be given. High frequency transmission is <10mW and is 100 times lower than the emissions of a common mobile phone or a microwave oven emitting an average of 1000mW.



Rilevatore di movimento a microonde con crepuscolare e stand-by regolabile, aggiungere Y dopo il codice

+ Euro 80,00 al prezzo di listino

Microwave motion detector with crepuscular and dimmable stand-by, add Y after the code + Euro 80.00 to the list price

Esempio applicativo
Installazione su corpo illuminante

*Application example
Installation on lighting body*



Specifiche tecniche - Technical specification	
Tensione di rete - Power supply	220-240Vac - 50/60Hz
Potenza - Power	1000W - 500VA
Frequenza - Frequency	5,8GHz
Angolo di rilevamento - Detection angle	360°
Velocità di rilevamento movimento Motion detection speed	0,5-3m/s
Altezza di installazione - Assembly height	1-15 m
Consumo energetico - Energy consumption	< 0,9W
Grado IP - IP degree	IP65
Tecnologia - Technology	Microonde - Microwave
Temperatura di funzionamento sensore Sensor operating temperature	-35...50°C
Tempo di spegnimento - Switch-off time	10 sec ÷ 30 min
Sensibilità lux - Lux sensitivity	5-200 lux 24h
Sensibilità - Sensitivity	12m (regolabile - reglable)
Trasmissione di segnale - Signal transmission	< 10mW
Stand-by dimming level	0%, 10%, 20%, 30%

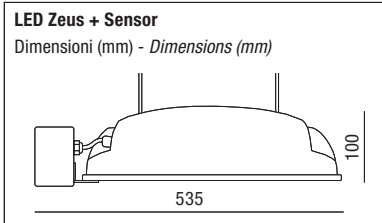
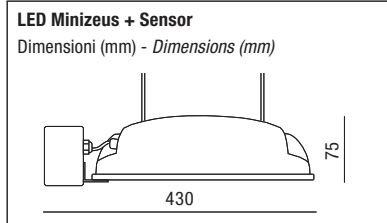

Completo di connettore IP68 per una rapida installazione
Complete with IP68 connector for quick installation

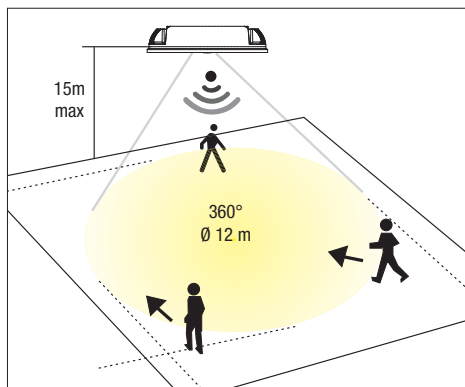
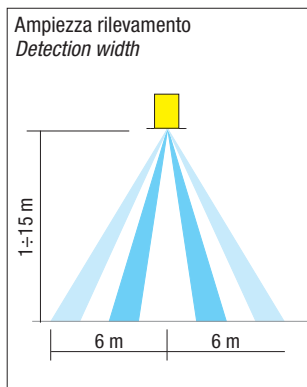

Trasmettitore incluso - Included transmitter

Carico acceso / Load on

Carico spento / Load off

Livello di luminosità in stand-by / Stand-by dimming level

OFF = 0%
M1 = 10%
M2 = 20%
M3 = 30%

Lampeggio di test del carico / Lamp will be auto test to be on and off

Funzionamento automatico impostazione di fabbrica = 24h tempo 10'' - distanza 100%
Automatic operation factory setting = 24h time 10'' - distance 100%

Ampiezza di rilevamento / Detection width

Sensibilità Lux / Lux sensitivity

Tempo di spegnimento / Hold time

Floodlight

LED Minizeus - LED Zeus

Soluzioni NON incluse per aumentare il risparmio energetico - NOT included solutions to increase energy saving

DYNA Control

Fig. 1 - Esempio applicativo 2 steps - Application example 2 steps

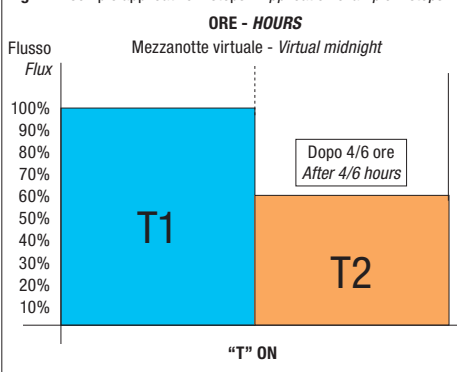

T1 = 100% Flusso luminoso
T1 = 100% Luminous flux

T2 = 70% Flusso luminoso
T2 = 70% Luminous flux

Minimo tempo di accensione per funzionamento automatico 4 ore (3 giorni).
Accensioni di 1 ora ignorate.
Accensioni da 1 a 4 ore oppure superiori alle 23 ore resettano il sistema.
The minimum ignition time for automatic operation is 4 hours (three days).
Ignitions 1 hour ignored.
Switching from 1 to 4 hours or higher with 23 hours reset the system.

DYNA CONTROL è un sistema di controllo del flusso luminoso delle lampade che si basa sul calcolo della mezzanotte virtuale. Il sistema entra in funzione alla prima accensione calcolando per 3 giorni i tempi di accensione. Il quarto giorno il sistema, in modo autonomo, calcola la mezzanotte virtuale eseguendo una regolazione del flusso e regolando la lampada come indicato sullo schema di Fig. 1. La riduzione del flusso luminoso avviene senza la necessità di alcun cavo di connessione aggiuntivo o dispositivo di comando esterno, questo sistema consente di ottenere un notevole risparmio energetico.
N.B. su richiesta è possibile eseguire la modifica delle impostazioni di fabbrica della mezzanotte virtuale adattandole alle specifiche del cliente.

DYNA CONTROL is a control system for the luminous flux of the lamps which is based on virtual midnight calculation. The system starts running when turned on for the first time, calculating the start-up times for 3 days. On the fourth day, the system automatically calculates the virtual midnight by performing a flux adjustment and adjusting the lamp as indicated on the diagram of Fig. 1. The reduction of the luminous flux occurs without the need for any additional connection cable or external control device. This system can achieve considerable energy saving.
N.B. the factory settings of the virtual midnight can be modified on request, adjusting them to the customer's specifications.

+ Euro 50,00 da listino - Aggiungere DC dopo il codice
+ Euro 50,00 to the price list - Add DC after the code

Su richiesta - On demand

LED Minizeus e LED Zeus a richiesta possono essere forniti in versione EMERGENZA
On request, LED Minizeus and LED Zeus are can be supplied in an EMERGENCY version



Batteria inclusa. Tempo di ricarica: 24h
Included battery. Charging time: 24h

Autonomy	LED EMERGENCY KIT
2h	6W SA-SE 2h - IP67
On demand	LED EMERGENCY KIT
3h	3W SA-SE 3h - IP67



Aggiungere 2E (2h) o 3E (3h) dopo il codice - + Euro 120,00 al prezzo di listino
Add 2E (2h) or 3E (3h) after the code - + Euro 120.00 to the list price

Dettagli - Details



LED Minizeus e LED Zeus vengono forniti completi di gancio per applicazione a sospensione
LED Minizeus e LED Zeus comes complete with hook for application to suspension



Dispositivo anticondensa: valvola di compensazione e riciclo dell'aria.
Anti-condensate device: valve for compensation and circulation of air.



Ottiche: realizzate in PMMA resistente ai raggi UV
Optics: made in PMMA resistant to UV radiation



Completo di connettore IP68 per una rapida installazione
Complete with IP68 connector for quick installation



LED Minizeus 200W
Driver esterno - External driver



LED Zeus 250W
Driver esterno - External driver

LED Zeus ATEX 2-22



Installazione: a parete o a sospensione.

Corpo e telaio: in alluminio pressofuso UNI EN 1706 verniciato con polvere termoindurente poliesteri.

Staffa di fissaggio: in acciaio, verniciata con polvere termoindurente poliesteri, con goniometro graduato per un corretto puntamento del fascio luminoso.

PG: pressacavo in metallo M20x1,5 ATEX PA66 (cavo Ø 10÷14mm²)

Verniciatura: di tipo poliesteri eseguita a polvere, resistente agli agenti atmosferici, alla corrosione e alla nebbia salina. RAL Yellow 1018

Ottica: semi concentrante realizzata in PMMA resistente ai raggi UV

Schermo: vetro temprato di spessore 4mm resistente agli shock termici e agli urti.

Protezione alle sovratensioni inclusa:
Modo differenziale 6kV (L-N)
Modo comune 10kV (L-GND, N-GND, L&N-GND)

Sorgente: LED **SAMSUNG**
Mantenimento del flusso luminoso minimo al 90% - 100.000h (L90B10) per il 90% dei LED.

Temperatura di colore: 4000K;

Driver: incorporato  0-10V.
Fattore di potenza ≥0,95.

Installation: on the wall or suspended.

Housing and frame: made by UNI EN 1706 Die-cast aluminum, coated with polyester thermoset powder.

Fixing bracket: made by stainless steel, coated with polyester thermoset powder, with graduated goniometer to allow the correct orientation of light beam

Metal cable glands: screwed M20x1,5 (Cable Ø 10÷14mm²)

Coating: coated with powdered polyester, resistant to atmospheric agents and corrosion and guaranteed in saline mist. RAL Yellow 1018

Optic: semi-clumping made in PMMA resistant to UV radiation

Shield: tempered glass with 4mm thickness resistant to thermal shocks and collisions.

Protection against overvoltages included:
Differential mode 6kV (L-N)
Standard mode 10kV (L - GND, N-GND, L&N-GND)

*Light source: LED **SAMSUNG***
Maintenance of minimum luminous flux to 90% - 100.000h (L90B10) for 90% of LED.

Color temperature: 4000K;

*Driver: included  0-10V.
Power factor ≥0,95*

IEP | ENERGY PETROLEUM INSTITUTE

IEP ATEX

(1) **Type Examination Certificate**

(2) Equipment or Protective Systems Intended for use in Potentially Explosive Atmospheres
Directive 2014/34/EU

(3) Type Examination Certificate Number: IEP 20 ATEX 0848

(4) Equipment: LED Zeus Type , Led Lighting Fixtures

(5) Firm Name: RELCO S.R.L.

(6) Firm Address: Via delle Azalee 6/A - 20090 Buccinasco (MI) - ITALY

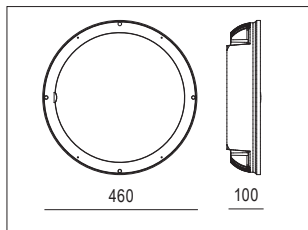
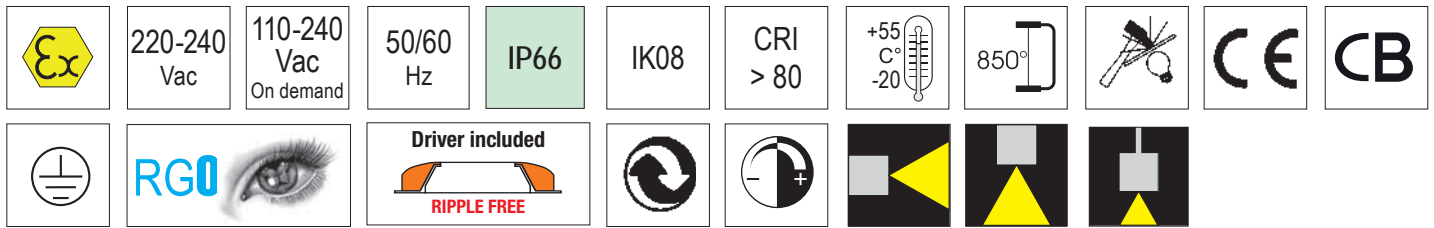

	colour	W	angle	K	nominal lm tc = 25°C	lm output	lm/W	pcs	Kg	CELL
1-10Vdc	G	175	50°	4000	23.100	21.000	120	1	9,70	334087.185ATX
1-10Vdc	G	210	50°	4000	27.700	25.200	120	1	9,70	334087.210ATX

A richiesta: potenze, ottiche e colorazione del LED diverse da quelle standard
On demand: powers, optics and LED colours different from the standard ones

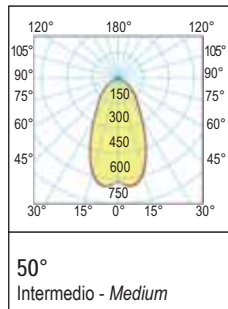

Protezione contro le atmosfere esplosive <i>Protection against explosive atmospheres</i>	CE Ex II 3G Ex nR IIC T4 Ge
Zona pericolosa ammessa <i>Hazardous area allowed</i>	CE Ex II 3D Ex tc IIIC T135° C Dc IP66 Zona 2 - Zone 2 Zona 22 - Zone 22
Normative di riferimento <i>Standard references</i>	EN60079-0 / EN60079-15 EN60079-31 / EN60079-28
Use: the light fitting is suitable for the environment with a danger of explosion of gas, dust and combustible fumes. The light fittings meet the requirements of Government Decree 116/2016 Coll. and European Community Directive N°. 2014/34/EU.	

LED Zeus ATEX viene fornito completo di gancio per applicazione a sospensione

LED Zeus ATEX comes complete with hook for application to suspension

Accessori non inclusi - Not Included accessories

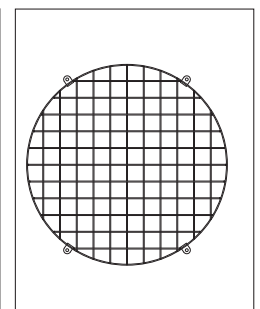
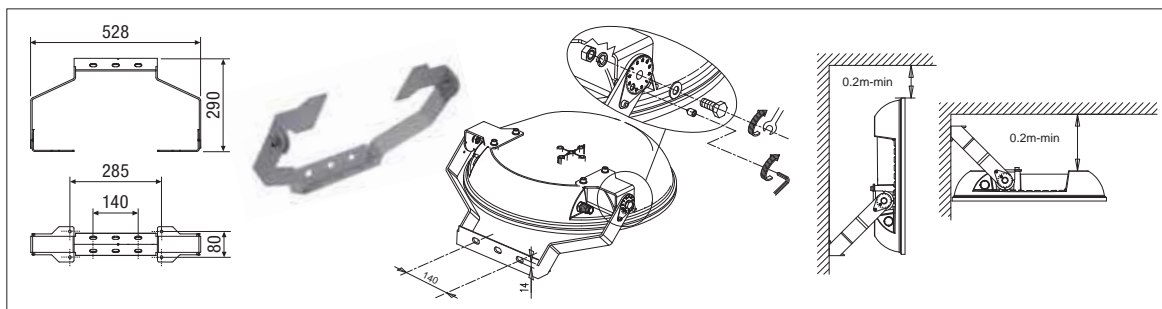

Code: 703959.0101
 Staffa sagomata orientabile per montaggio a parete più goniometro per puntamento proiettore
Shaped adjustable bracket for wall mounting complete with protractor pointing to the projector

Code: 800016.0101
 Griglia di protezione
Protection grid

BASIC series LED Punto Highbay



LED Punto Highbay è un apparecchio progettato per fornire un'illuminazione uniforme e senza interruzioni per applicazioni industriali ed è una soluzione ideale per altezze di montaggio più elevate, applicazioni ad alta temperatura e industria pesante speciale.

Punto Highbay Led is a luminaire designed to provide uninterrupted and uniform lighting for industrial application and is an ideal solution for higher mounting heights, high temperature applications and special heavy-duty industry.

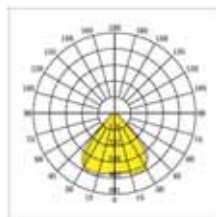
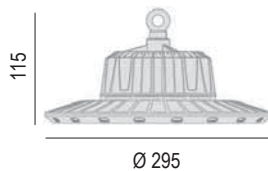

LED Punto 100

Color	Diffusor	Code
<input checked="" type="checkbox"/> Nero Black	<input type="checkbox"/> Vetro Glass	RL2251022

Sorgente Source	
Potenza Total power	100W
Temperatura di colore Color temperature	4000K
Flusso luminoso Lighting output	10.000Lm
Peso kg weight kg	1,65

CRI>80 CELL

100-264V 50/60Hz

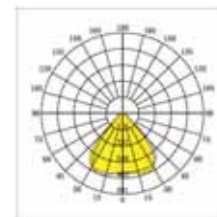
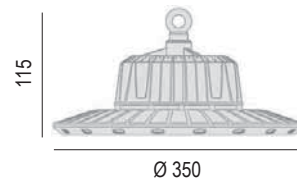

LED Punto 150

Color	Diffusor	Code
<input checked="" type="checkbox"/> Nero Black	<input type="checkbox"/> Vetro Glass	RL2251032

Sorgente Source	
Potenza Total power	150W
Temperatura di colore Color temperature	4000K
Flusso luminoso Lighting output	15.000Lm
Peso kg weight kg	2,50

CRI>80 CELL

100-264V 50/60Hz

Colore nero RAL 9004.

Ottica: diffondente

Schermo: in policarbonato 4mm resistente agli shock termici e agli urti.

Sorgente LED SMD: incorporato con temperatura di colore 4000K; altre temperature di colore a richiesta.

Driver: incorporato fattore di potenza: $\geq 0,9$

RAL 9004 black color.

Optic: diffused

Shield: in polycarbonate with 4mm thickness resistant to thermal shocks and collisions

Light source SMD LED: included with color temperature 4000K; other color temperatures available on demand.

Driver: included Power factor: $\geq 0,9$



Dissipatore in alluminio pressofuso per un'ottima dissipazione del calore e un'eccellente resistenza alla corrosione.

Die-cast aluminum housing offers excellent corrosion-resistance and robustness.

Installazione
intallation

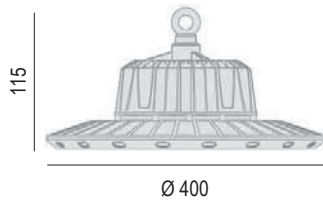

Ø 400

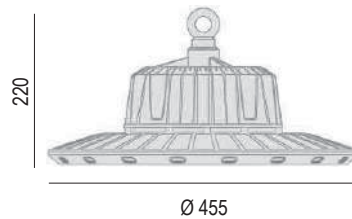
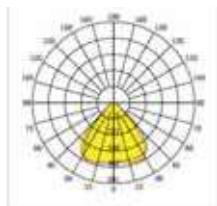

Ø 455

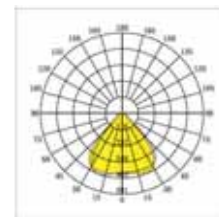

LED Punto 200

Color	Diffusor	Code
Nero Black	Vetro Glass	RL2251042

Sorgente Source	
Potenza Total power	200W
Temperatura di colore Color temperature	4000K
Flusso luminoso Lighting output	20.000Lm
Peso kg weight kg	3,00

CRI>80 CELL

100-264V 50/60Hz

LED Punto 250

Color	Diffusor	Code
Nero Black	Vetro Glass	RL2251052

Sorgente Source	
Potenza Total power	250W
Temperatura di colore Color temperature	4000K
Flusso luminoso Lighting output	25.000Lm
Peso kg weight kg	4,20

CRI>80 CELL

100-264V 50/60Hz

LED AGP Evolution ATEX 2-22



Proiettore da incasso, parete e plafone particolarmente adatto per magazzini, garage, stazioni di servizio e luoghi con atmosfera potenzialmente esplosiva. Completo di alimentatore elettronico.

Installazione: ad incasso, parete e plafone

Corpo e telaio: in alluminio pressofuso

Verniciatura: di tipo poliestere eseguita a polvere, resistente agli agenti atmosferici e alla corrosione. Colore Bianco RAL 9003.

PG: pressacavo in metallo M16 (cavo Ø 4+8mm²)

Ottica: diffondente realizzata in PMMA resistente ai raggi UV

Sorgente: LED **PHILIPS** lumileds

Mantenimento del flusso luminoso minimo al 90% - 100.000h (L90B10) per il 90% dei LED

Driver: incorporato

Fattore di potenza ≥ 0,95.

Recessed flood light particularly suitable for warehouses, garages, service stations and places in general with potentially explosive atmosphere. Complete with electronic ballast.

Installation: recessed, wall and ceiling

Body and frame: die cast aluminum

Coating: coated with powdered polyester, resistant to atmospheric agents and corrosion. White colour RAL 9003

PG: M16 metal cable gland (cable 4+8mm²)

Optic: wide made of UV-resistant PMMA

*Light source: LED **PHILIPS** lumileds*

Maintenance of minimum luminous flux to 90% - 100.000h (L90B10) for 90% of LED.

Driver: certified.

Power factor ≥ 0,95.

Use: the light fitting is suitable for the environment with a danger of explosion of gas, dust and combustible fumes. The light fittings meet the requirements of Government Decree 116/2016 Coll. and European Community Directive N°. 2014/34/EU.

Floodlight

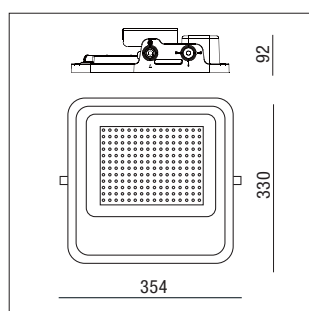

	100-277 Vac	50/60 Hz	IP66	IK10	CRI > 70	+55 C -20	850°

colour	W	angle	K	nominal Im tc = 25°C	Im output	lm/W	pcs	Kg	CELL
[B]	100	120°	4000	18.400	16.000	160	1	4,00	RL04-100
[B]	150	120°	4000	26.700	23.250	155	1	4,00	RL04-150

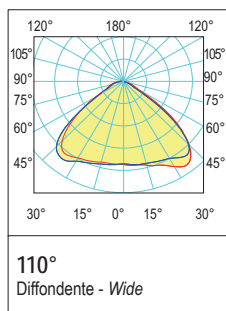

Protezione contro le atmosfere esplosive <i>Protection against explosive atmospheres</i>	
Zona pericolosa ammessa <i>Hazardous area allowed</i>	Zona 2 - Zone 2 Zona 22 - Zone 22
Normative di riferimento <i>Standard references</i>	EN 60079-0:2012/A11:2013 EN 60079-11:2012 EN60079-31:2014

LED AGP Evolution ATEX 2-22

Accessori non inclusi - *Not included accessories*



Cod. RL04/PL
Accessorio per installazione a plafone
Accessory for ceiling installation



Cod. RL04/R
Accessorio per installazione a incasso
Accessory for recessed installation
Dimensioni - *Dimensions*: 400x400mm



Cod. RL04/S
Accessorio staffa
Bracket accessory



Cod. 703952.NEW
Attacco palo per 1 o 2 proiettori, Ø60/76mm
Pole attachment for either 1 or 2 floodlights, size Ø 60/76mm.

Application example



Floodlight

LED Lampo serie



Vedi Pag. VI - See page VI

Innovativi proiettori a LED progettati per illuminare campi sportivi, stadi, aree di parcheggio, aeroporti e grandi aree in genere.

Installazione: sospensione, parete/plafone e testa palo (completo di staffa di fissaggio).

Corpo e telaio: in alluminio e acciaio verniciato con polvere termoindurente poliestere.

Staffa di fissaggio: in acciaio, verniciata con polvere termoindurente poliestere

Verniciatura: di tipo poliestere eseguita a polvere, resistente agli agenti atmosferici e alla corrosione marina.
Colore Grigio RAL 9007.

Ottica: concentrante, semi concentrante, diffondente e asimmetrica.

Lenti: PMMA autoestinguenti antiurto

Sorgente: LED SMD 5050

Temperatura di colore: 4000K; a richiesta (2200K - 2700K - 3000K - 5000K - Consegna 90 giorni).

Protezione alle sovratensioni inclusa:

Modo differenziale 6kV (L-N)

Modo comune 10kV (L-GND, N-GND, L&N-GND)

Mantenimento del flusso luminoso minimo al 80% - 50.000h (L80B10) per il 90% dei LED.

LED Driver RELCO: 

Conforme alla Norma: IEC 61000-4-5.

Fattore di potenza: $\geq 0,98$

Norme di riferimento: IEC 61000-4-5;

EN60598-1; EN60598-2-1; EN62471; EN62031;

EN60598-2-5; EN61547

Innovative LED projectors designed to light up sport fields, stadiums, car parks, airports and wide spaces in general.

Installation: on vertical and horizontal surfaces (complete with fixing bracket)

Housing and frame: made by UNI EN 1706 die-cast aluminium, coated with polyester thermoset powder.

Fixing bracket: made by stainless steel, coated with polyester thermoset powder, with graduated goniometer to allow the correct orientation of light beam

Coating: coated with powdered polyester, resistant to atmospheric agents and marine corrosion.

Grey colour RAL 9007

Optic: clumping, semi-clumping, diffused and asymmetric

Shield: tempered glass with 4mm thickness resistant to thermal shocks and collisions

Light source: LED SAMSUNG

Color temperature: 4000K; on demand (2200K - 2700K - 3000K - 5000K. Delivery time: 60 days)

Protection against overvoltages included:

Differential mode 6kV (L-N)

Standard mode 10kV (L - GND, N-GND, L&N-GND).

Maintenance of minimum luminous flux to 80% - 50.000h (L80B10) for 90% of LED.

LED Driver Relco: 

Conforming to IEC 61000-4-5.

Power factor: $\geq 0,98$

Standard reference: IEC 61000-4-5; EN60598-1;

EN60598-2-1; EN62471; EN62031; EN60598-2-5;

EN61547

LED Lampo serie



Floodlight

100-240 Vac	110 Vac On demand	50/60 Hz	IP66	IK10	CRI > 80	+40 C -40	850°				CE
	RG0	LOW FLICKER	Driver included RIPPLE FREE								

LED Lampo 2

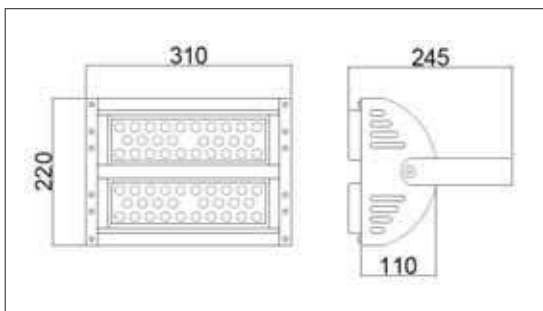

colour	W	angle	K	nominal lm tc = 25°C	lm output	lm/W	pcs	Kg	CELL
G	120	25°	4000	23.750	20.650	172	1	2,90	RFL120254K
G	120	40°	4000	23.750	20.650	172	1	2,90	RFL120404K
G	120	60°	4000	23.750	20.650	172	1	2,90	RFL120604K
G	120	60°	3000	23.750	20.650	172	1	2,90	RFL120603K
G	120	ASY	4000	23.750	20.650	172	1	2,90	RFL120ASY4K

LED Lampo 3

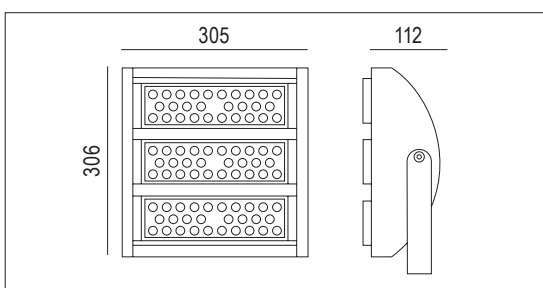

colour	W	angle	K	nominal lm tc = 25°C	lm output	lm/W	pcs	Kg	CELL
G	180	25°	4000	35.600	31.000	172	1	3,60	RFL180254K
G	180	40°	4000	35.600	31.000	172	1	3,60	RFL180404K
DALI 2 G	180	40°	4000	35.600	31.000	172	1	3,60	RFL180404KDA
G	180	60°	4000	35.600	31.000	172	1	3,60	RFL180604K
G	180	60°	3000	35.600	31.000	172	1	3,60	RFL180603K
G	180	ASY	4000	35.600	31.000	172	1	3,60	RFL180ASY4K

LED Lampo 4

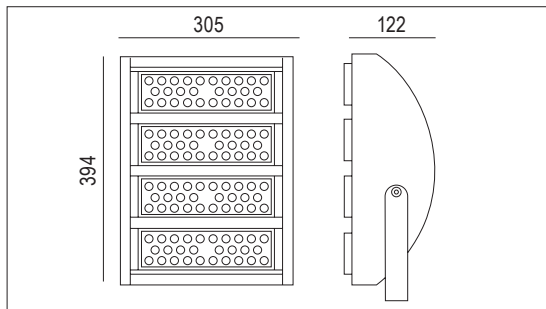

colour	W	angle	K	nominal lm tc = 25°C	lm output	lm/W	pcs	Kg	CELL
G	240	25°	4000	47.500	41.300	172	1	5,40	RFL240254K
G	240	40°	4000	47.500	41.300	172	1	5,40	RFL240404K
G	240	60°	4000	47.500	41.300	172	1	5,40	RFL240604K
G	240	60°	3000	47.500	41.300	172	1	5,40	RFL240603K
G	240	ASY	4000	47.500	41.300	172	1	5,40	RFL240ASY4K

LED Lampo 6

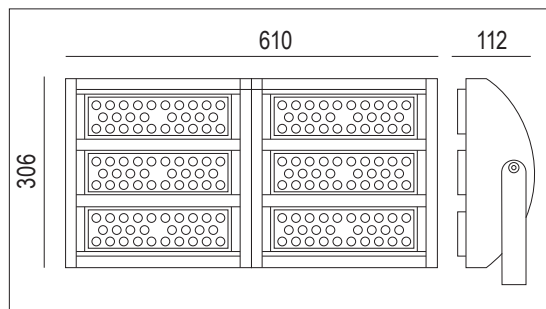

colour	W	angle	K	nominal lm tc = 25°C	lm output	lm/W	pcs	Kg	CELL
G	240	10°	4000	47.500	41.300	172	1	7,50	RFL350104K
G	350	25°	4000	70.000	60.200	172	1	7,50	RFL350254K
G	350	40°	4000	70.000	60.200	172	1	7,50	RFL350404K
G	350	40°	4000	70.000	60.200	172	1	7,50	RFL350404KDA
G	350	60°	4000	70.000	60.200	172	1	7,50	RFL350604K
G	350	ASY	4000	70.000	60.200	172	1	7,50	RFL350ASY4K
G	350	ASY	4000	70.000	60.200	172	1	7,50	RFL350ASY4KDA

LED Lampo 10



colour	W	angle	K	nominal lm tc = 25°C	lm output	lm/W	pcs	Kg	CELL
G	400	10°	4000	64.400	56.000	140	1	16,00	RFL500104K
G	500	25°	4000	96.000	83.500	167	1	16,00	RFL500254K
G	500	40°	4000	96.000	83.500	167	1	16,00	RFL500404K
DALI 2	G	500	40°	96.000	83.500	167	1	16,00	RFL500404KDA
G	500	60°	4000	96.000	83.500	167	1	16,00	RFL500604K
DALI 2	G	500	60°	96.000	83.500	167	1	16,00	RFL500604KDA
G	500	ASY	4000	96.000	83.500	167	1	16,00	RFL500ASY4K

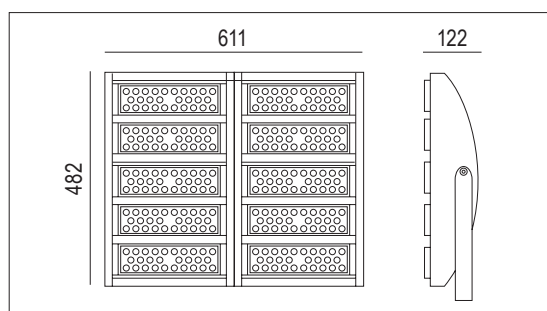

LED Lampo 12



colour	W	angle	K	nominal lm tc = 25°C	lm output	lm/W	pcs	Kg	CELL
G	480	10°	4000	77.280	67,200	140	1	20,00	RFL700104K
G	700	25°	4000	134.400	116.900	167	1	20,00	RFL700254K
G	700	40°	4000	134.400	116.900	167	1	20,00	RFL700404K
G	700	60°	4000	134.400	116.900	167	1	20,00	RFL700604K
G	700	ASY	4000	134.400	116.900	167	1	20,00	RFL700ASY4K

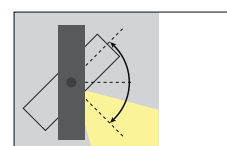
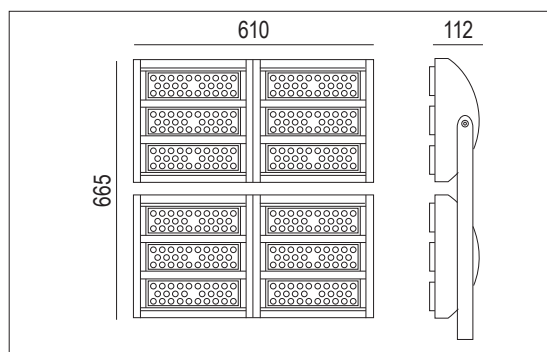

Rotazione gruppo ottiche $\pm 90^\circ$
(ogni gruppo è indipendente)
Optical group rotation $\pm 90^\circ$
(each group is independent)

LED Lampo 18



colour	W	angle	K	nominal lm tc = 25°C	lm output	lm/W	pcs	Kg	CELL
G	800	10°	4000	128.000	112.000	140	1	30,00	RFL1000104K
G	1000	25°	4000	190.000	167.000	167	1	30,00	RFL1000254K
G	1000	40°	4000	190.000	167.000	167	1	30,00	RFL1000404K
G	1000	60°	4000	190.000	167.000	167	1	30,00	RFL1000604K
G	1000	ASY	4000	190.000	167.000	167	1	30,00	RFL1000ASY4K

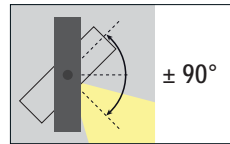
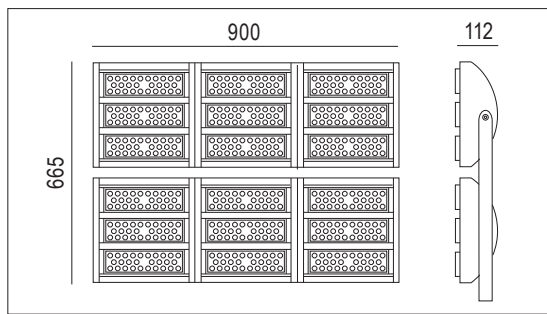

Rotazione gruppo ottiche $\pm 90^\circ$
 (ogni gruppo è indipendente)
 Optical group rotation $\pm 90^\circ$
 (each group is independent)

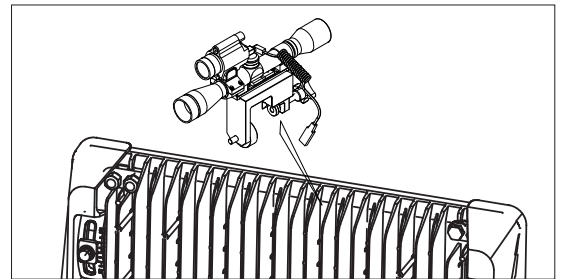

Accessorio puntatore laser
 Laser point accessory



Floodlight

Luce solo all'occorrenza - *Light only when needed*



Cod. ES-M08A

Rilevatore di movimento a microonde con crepuscolare e stand-by regolabile, aggiungere Y dopo il codice
Per maggiori informazioni vedi Pag. 20

*Microwave motion detector with crepuscular and dimmable stand-by, add Y after the code,
For more information see Page 20*

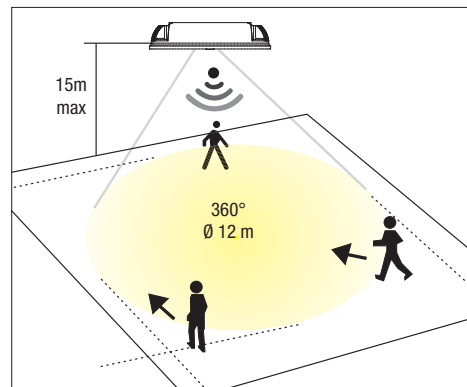

Cod. 703952.NEW

Attacco palo per l'installazione di 1 proiettore, Ø 60/76 mm.
In ferro verniciato con polveri termoindurenti poliesteri resistenti alla corrosione ed agli agenti atmosferici.

Pole attachment for the installation of 1 projector, size Ø 60/76 mm. Iron coated with polyester thermosetting powder coating, offering high resistance to rust and external atmospheric agents.



Cod. CARTER1 (LED Lampo 120W)

Cod. CARTER2 (LED Lampo 180W)

Cod. CARTER3 (LED Lampo 240W)

Cod. CARTER4 (LED Lampo 350W - 2 moduli per LED Lampo 700W)

Cod. CARTER5 (LED Lampo 500W)

CARTER per un'ulteriore protezione

CARTER for enhanced protection and design

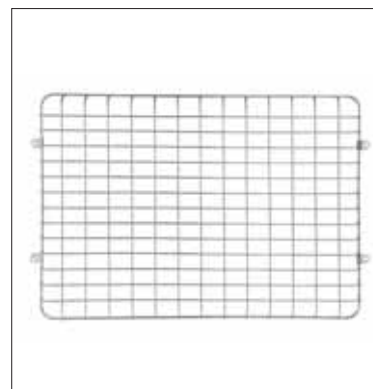

Cod. RETE140 (LED Lampo 120W)

Cod. RETE180 (LED Lampo 180W)

Cod. RETE240 (LED Lampo 240W)

Griglia di protezione - *Protection grid*



Cod. GFR100.000

Gancio per applicazione a sospensione

Hook for suspension application

Dettagli - *Details*



LED Lampo serie

I lm/W della serie LED Lampo sono stati certificati da istituto esterno

The lm/W of the LED Lampo series have been certified by an external institute



Apparecchio

Nome PROIETTORE LED LAMPO

Rilievo

Codice CL2255-18-15G2

Nome

Flusso Apparecchio	30.000 lm	Potenza Apparecchio	175 W	Efficacia	167 lm/W	Rendimento	100.03%
Flusso sorgente	30.000 lm	Valore Massimo	31.000 cd	Posizione	C=0.00 G=0.00	CG	Rotosimmetrico

Ottiche di serie - Standard optics

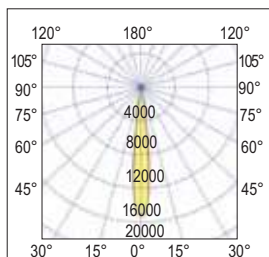

10°
Super spot

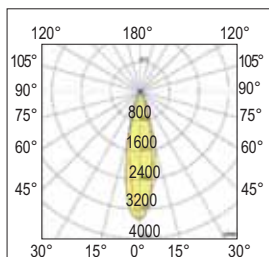

25°
Concentrante - Spot

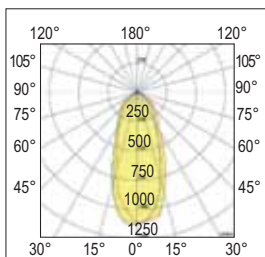

40°
Semi-diffondente - Wide

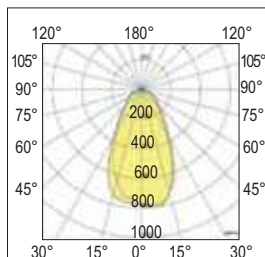

60°
Diffondente - Flood

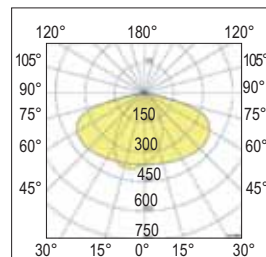

ASY
Asimmetrico - Asymmetric

Floodlight

Applicazioni - Applications

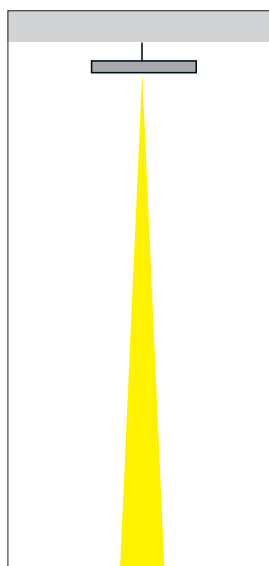

10°
Super spot

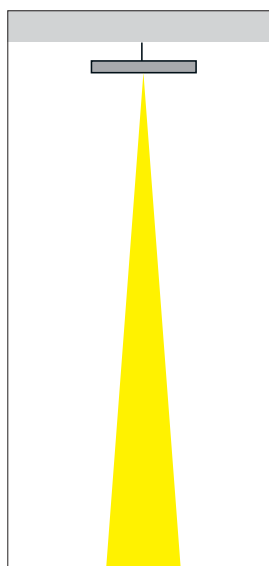

25°
Concentrante - Spot

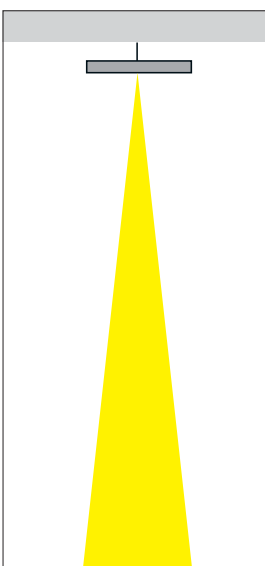

40°
Semi-diffondente - Wide

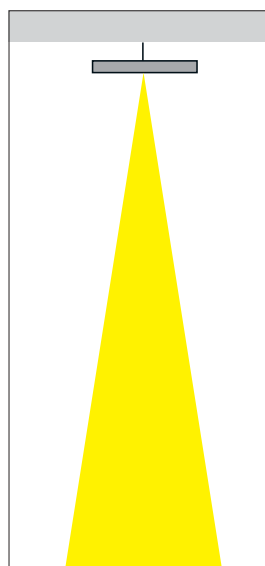

60°
Diffondente - Flood

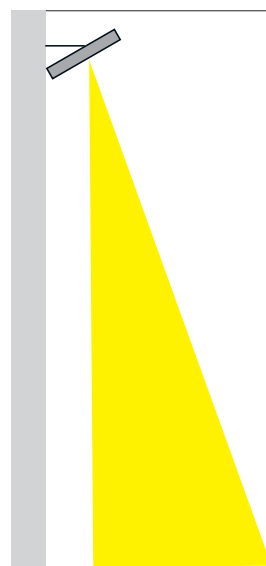

ASY
Asimmetrico - Asymmetric



Apparecchi a LED professionali per l'illuminazione di gallerie e strade.

Installazione: parete o plafone

Sistema di fissaggio: staffa in acciaio verniciata colore grigio

Corpo e telaio: in alluminio pressofuso UNI EN 1706 verniciato con polvere termoindurente poliestere.

Verniciatura: di tipo poliestere eseguita a polvere, resistente agli agenti atmosferici e alla corrosione. Colore Grigio RAL9005

Schermo: vetro temperato di spessore 4mm resistente agli shock termici e agli urti.

Sorgente: LED **SAMSUNG** 

Temperatura di colore: 4000K (5000K a richiesta).

Protezione alle sovratensioni inclusa:

Modo differenziale 6kV (L-N)

Modo comune 8kV (L-GND, N-GND, L&N-GND)

A richiesta: versione con protezione maggiorata (10kV) contro gli impulsi aggiungendo il cod. RO0640/N.

Driver: incorporato 

Fattore di potenza $\geq 0,98$.

Norme di riferimento: IEC 61000-4-5; EN60598-1; EN60598-2-1; EN62471; EN62031; EN60598-2-3; EN61547

Professional LED luminaires for tunnel and street lighting.

Installation: on the wall or ceiling

Fixing system: gray painted steel bracket

Housing and frame: made by UNI EN 1706 die-cast aluminum, coated with polyester thermoset powder.

Coating: coated with powdered polyester, resistant to atmospheric agents, corrosion.

Grey RAL 9005 color.

Shield: tempered glass with 4mm thickness resistant to thermal shocks and collisions.

Source: LED **SAMSUNG** 

Color temperature: 4000K (5000K on demand).

Protection against overvoltages included:

Differential mode 6kV (L-N)

Standard mode 8kV (L - GND, N-GND, L&N-GND).

On demand: this version with greater protection (10kV) with code RO0640/N.

Driver: included 

Power factor $\geq 0,98$

Standard reference: IEC 61000-4-5; EN60598-1; EN60598-2-1; EN62471; EN62031; EN60598-2-3; EN61547

A richiesta - On demand

Onde convogliate
Waves conveyed



Wireless

Vedi Pag. VI - See page VI

220-240 Vac	110 Vac On demand	50/60 Hz	IP66	IK09	CRI > 70	+40 C° -30	+50 C° -30	On demand	850°		
					LOW FLICKER						

LED Tunnel 1

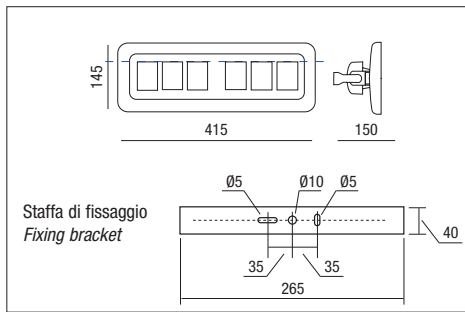

colour	W	Optic	K	nominal lm tc = 25°C	lm output	lm/W	pcs	Kg	CELL
G	80	ASY1	4000	11.960	10.400	130	1	2,70	TUN1ASY1
G	80	ASY2	4000	11.960	10.400	130	1	2,70	TUN1ASY2
G	80	SIM1	4000	11.960	10.400	130	1	2,70	TUN1SIM1
G	80	SIM2	4000	11.960	10.400	130	1	2,70	TUN1SIM2
G	80	SIM3	4000	11.960	10.400	130	1	2,70	TUN1SIM3

LED Tunnel 2

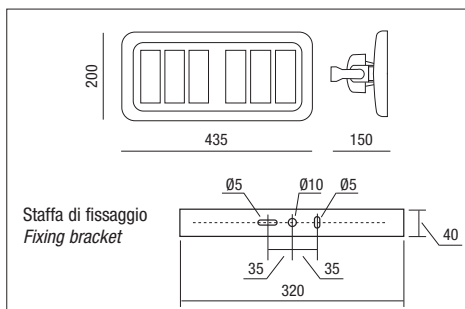

colour	W	Optic	K	nominal lm tc = 25°C	lm output	lm/W	pcs	Kg	CELL
G	120	ASY1	4000	18.000	15.600	130	1	3,70	TUN2ASY1
G	120	ASY2	4000	18.000	15.600	130	1	3,70	TUN2ASY2
G	120	SIM1	4000	18.000	15.600	130	1	3,70	TUN2SIM1
G	120	SIM2	4000	18.000	15.600	130	1	3,70	TUN2SIM2
G	120	SIM3	4000	18.000	15.600	130	1	3,70	TUN2SIM3

Ottiche - Optics

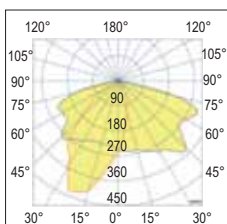

ASY 1
Asimmetrica - Asymmetric

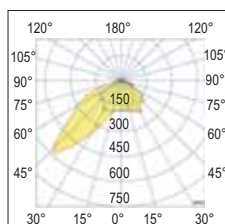

ASY 2
Asimmetrica - Asymmetric

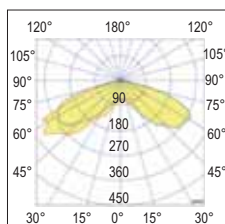

SIM 1
Simmetrica - Symmetric

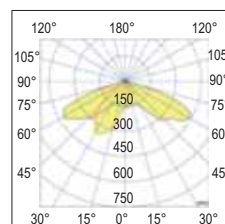

SIM 2
Simmetrica - Symmetric

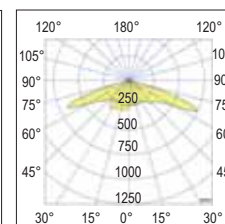

SIM 3
Simmetrica - Symmetric



LED Tunnel

Linee guida per l'illuminazione di un tunnel - Guidelines for tunnel lighting

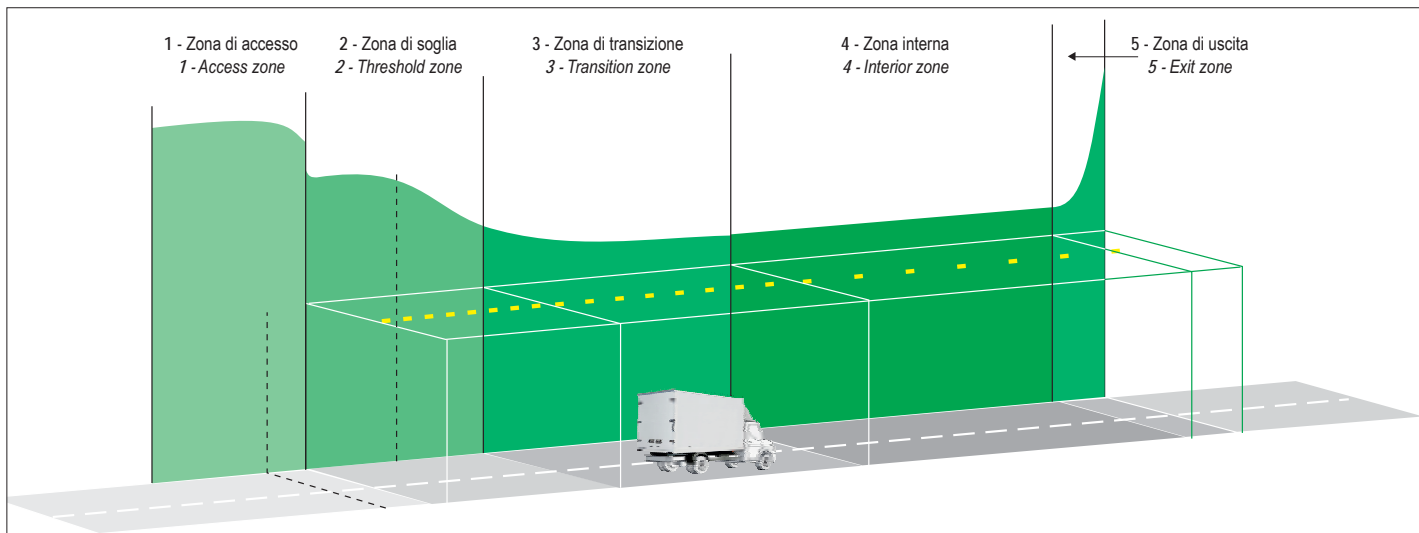

5 - Zona di uscita

È la parte del tunnel tra la zona interna e il portale di uscita. In questa zona, durante il giorno, la visione di un guidatore che si avvicina all'uscita è influenzata dalla luminosità all'esterno del tunnel. L'occhio umano può adattarsi quasi istantaneamente da bassi ad alti livelli di luce (non viceversa), quindi i processi indicati per la fase di ingresso nel tunnel non valgono per la fase di uscita. Tuttavia, in alcuni casi può essere necessaria un'illuminazione rinforzata, in cui è necessario un contrasto davanti o dietro al conducente; per esempio quando l'uscita non è visibile o quando l'uscita agisce come entrata in caso di lavori di emergenza o di manutenzione in cui può essere parte di un tunnel gemello chiuso. La lunghezza può essere al massimo di 50m e il livello di luce 5 volte superiore al livello della zona interna.

The CIE international recommendations (CIE 88-1990) classify the tunnel into 5 zones, each of which has its own established amount of light required.

The zones are classified based on the time the human eye requires to visually adjust when passing between the outside and inside of the tunnel (and vice versa).

1 - Access zone

The part of the open road immediately outside (in front of) the tunnel portal. From this zone, drivers must be able to see inside the tunnel to detect potential obstacles and drive through the tunnel without reducing the vehicle's speed. The ability of the human eye to adjust to the access zone determines the lighting level of the next part of the tunnel. One of the methods used by CIE to calculate the visual adjustment is the L20 method, which considers the average luminance of an environment in a visual cone of 20°, centred on the line of sight of the driver from the beginning of the access zone.

2 - Threshold zone

The length of the threshold zone is at least equal to the "stopping distance of the vehicle". In the first section, the luminance must remain constant and is related to the external luminance (L20) and traffic conditions. At the end, the luminance level provided can be quickly reduced up to 40% of the initial value.

3 - Transition zone

In the transition zone, the luminance is progressively reduced to reach the level required in the interior zone. The reduction phases must not exceed a ratio of 1: 3 as they depend on the ability of the human eye to visually adapt to the environment. The transition zone ends when the luminance is 3 times the interior level.

4 - Interior zone

The part of the tunnel following directly after the transition zone. It stretches from the end of the transition zone to the beginning of the exit zone. The lighting levels are related to the speed and density of the traffic, as shown in the following table

Luminance that must be maintained in the interior zone

Extra urban, traffic, speed (<70Km/h)	from 1.5 to 3cd/m ²
Extra urban, traffic, speed (>70Km/h)	from 2 to 6cd/ m ²
Highway.....	from 4 to 10cd/ m ²
Urban.....	from 4 to 10cd/ m ²

5 - Exit zone

The exit zone begins at the end of the interior zone. It ends at the exit portal of the tunnel. In this zone, during the day, the vision of a driver approaching the exit is affected by the brightness outside the tunnel. The human eye can adapt almost instantly from low to high light levels (not vice versa); therefore, the processes indicated for the tunnel access stage do not apply to the exit stage. However, reinforced lighting may be required in some cases, where a contrast is required in front of or behind the driver. For example, when the exit is not visible or when the exit acts as an entrance in case of emergency or maintenance work where it can be part of a closed twin tunnel. It can be maximum 50m long and the light level 5 times higher than the level of the interior zone.

Le linee guida CIE (CIE 88-1990) classificano il tunnel in 5 zone per ciascuna delle quali viene stabilita la quantità di luce richiesta all'interno dello stesso.

Le zone vengono classificate in base al tempo di adattamento visivo che l'occhio umano riesce avere nel passaggio tra esterno ed interno del tunnel (e viceversa).

1 - Zona di accesso

Tratto di strada non coperto che porta all'interno del tunnel stesso. Da questa zona, i conducenti devono essere in grado di vedere nel tunnel per rilevare possibili ostacoli e guidare nel tunnel senza ridurre la velocità di marcia del veicolo. La capacità dell'occhio umano di adattarsi alla zona di accesso, regola il livello di illuminazione della parte successiva del tunnel. Uno dei metodi utilizzati da CIE, per calcolare l'adattamento visivo, è il metodo L20, che stabilisce la luminanza media di un ambiente, in un cono visivo di 20°, partendo dalla linea di vista del conducente dall'istante in cui questo accede alla zona.

2 - Zona di soglia

Questa zona corrisponde in lunghezza alla "distanza di arresto di un veicolo". Nella prima parte la luminanza deve rimanere costante ed è collegata alla luminanza esterna (L20) e alle condizioni del traffico. Nella parte terminale il livello di luminanza fornito può essere rapidamente ridotto al 40% del valore iniziale.

3 - Zona di transizione

Lungo la zona di transizione, la luminanza viene ridotta progressivamente per arrivare al livello richiesto nella zona interna. Le fasi di riduzione non devono superare un rapporto di 1: 3 in quanto dipendono dalla capacità di adattamento visivo dell'occhio umano all'ambiente. La fine della zona di transizione viene raggiunta quando la luminanza è pari a 3 volte il livello interno.

4 - Zona interna

Questa è l'area tra la zona di transizione e di uscita, spesso è anche il tratto più lungo del tunnel. I livelli di illuminazione sono collegati alla velocità e alla densità del traffico, come indicato nella tabella seguente

Luminanza che deve essere mantenuta nella zona interna

Extra urbano, traffico, velocità (<70Km/h)	da 1.5 a 3cd/m ²
Extra urbano, traffico, velocità (>70Km/h)	da 2 a 6cd/ m ²
Autostrada	da 4 a 10cd/ m ²
Urbano.....	da 4 a 10cd/ m ²

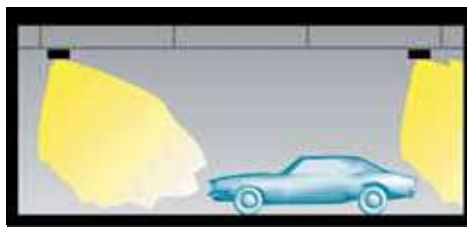



La certificazione fotometrica dei nostri apparecchi viene sempre effettuata da un istituto esterno. Efficienza luminosa e "Im Output" sono quindi il risultato di tale istituto.

The photometric certification of our appliances is always carried out by an external institute. Luminous efficiency and "Im Output" are therefore the result of this institute.

1-10Vdc



DMX

Wireless

Il LED Milano Sport è un proiettore per l'illuminazione di stadi e strutture sportive, grandi infrastrutture (aeroporti, stazioni, ecc.), aree di parcheggio, zone di stoccaggio (industriali, portuali, ecc.).

La particolare forma permette di avere diverse potenze e fasci luminosi stretti e precisi, specifici per l'installazione a notevole altezza. La qualità delle parti elettroniche e del corpo lampada e dei materiali assicurano sicurezza in fase di esercizio nelle condizioni ambientali più critiche.

Installazione: su palo o a parete

Corpo e telaio: alluminio pressofuso

Staffa di fissaggio: in acciaio zincato a caldo, con goniometro graduato per un corretto puntamento del fascio luminoso

Verniciatura: speciale eseguita a polvere, resistente agli agenti atmosferici e alla corrosione e alle nebbie. Colore Grigio RAL 9007.

Ottica: in policarbonato metallizzato

Schermo: vetro temperato ultra-white resistente agli shock termici e agli urti h 4mm

Sorgente: LED

Mantenimento del flusso luminoso minimo al 70%: 80.000h (L70B20) per l'80% dei LED.

Temperatura di colore: 5700K (CRI 90) specifica per gli impianti con riprese televisive o 4000K (CRI 80);

Driver LED multipotenza:

Certificato

Fattore di potenza: $\geq 0,9$

Protezione: 5/10kV

Norme di riferimento

EN60598-1; EN60598-2-1; EN62471; EN62031

EN60598-2-5; EN61547

LED Milano Sport is a projector for indoor and outdoor stadiums and sports grounds, large infrastructures (airports, stations, etc.), parking areas and storage areas (on industrial premises, at ports, etc.).

Different light intensities and narrow and precise light beams are possible due to the special design of the lamp body and light source, specifically for installation at a considerable height. The quality of the electronic parts, lamp body and materials ensure operating safety under even the most critical of environmental conditions.

Installation: on pole or wall

Housing and frame: die-cast aluminium

Fitting stirrup: in hot galvanised steel with graduated goniometer for correct pointing of the light beam

Painting: special powder coating, resistant to atmospheric agents, corrosion and mists. Grey RAL 9007.

Optics: concentrator and asymmetric optics

Screen: ultra-white thermal shock and collision resistant tempered glass.

Source: LED

Maintenance of 70% minimum luminous flux: 80,000h (L70B20) for 80% of the LEDs.

Color temperature: 5700K (CRI 90) specific for systems with television footage or 4000K (CRI 80);

Driver LED multipower:

Certified

Power factor: $\geq 0,9$

Surge protection: 5/10kV

Standard reference

EN60598-1; EN60598-2-1; EN62471; EN62031

EN60598-2-5; EN61547

LED Milano Sport

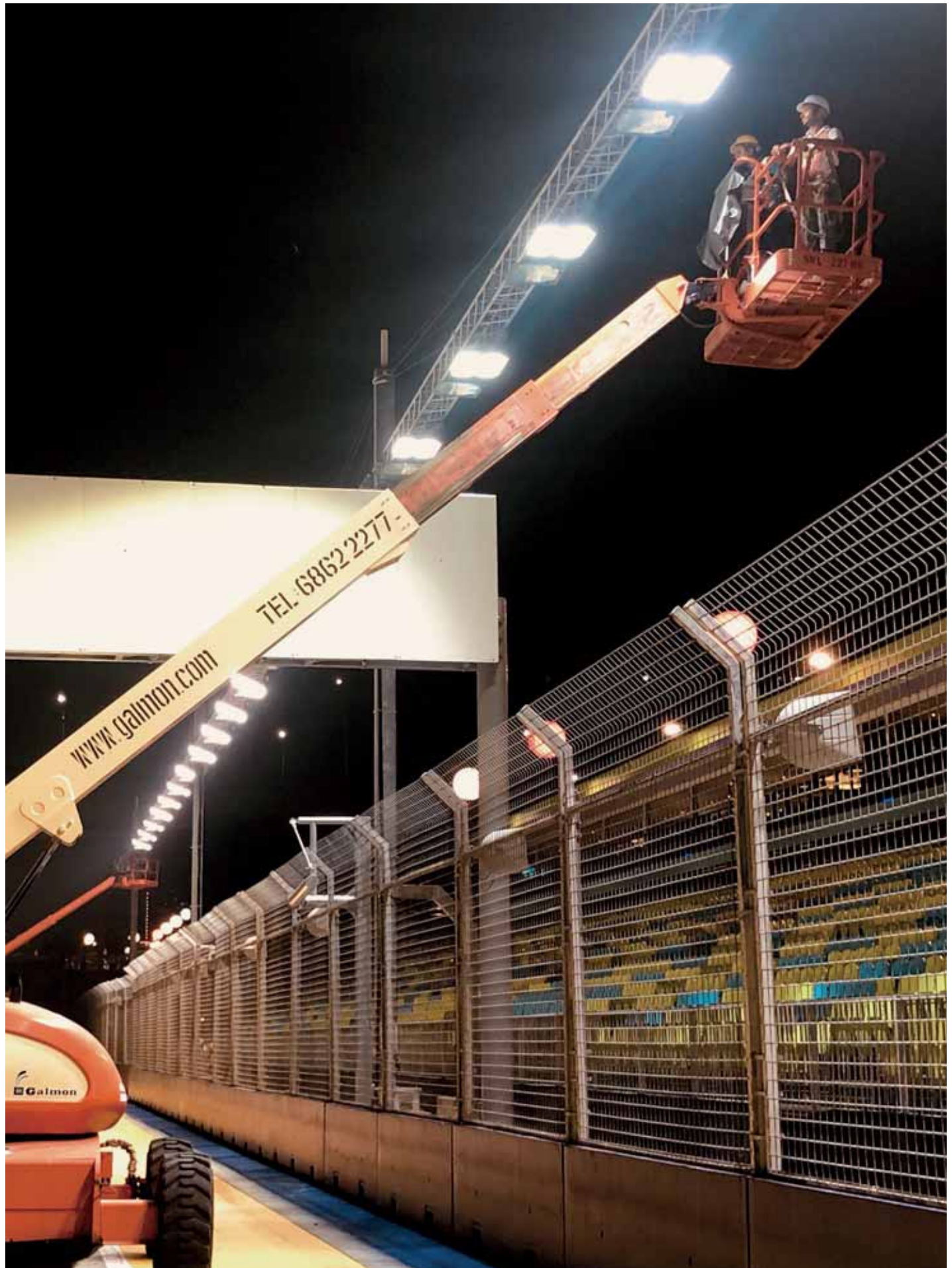

Floodlight

LED Milano Sport



Floodlight

100-240 Vac	50/60 Hz	IP66	IK08	+50 C° -20	850°		CE	 17 pending			
	LOW FLICKER	Driver included RIPPLE FREE									

LED Milano Sport 1

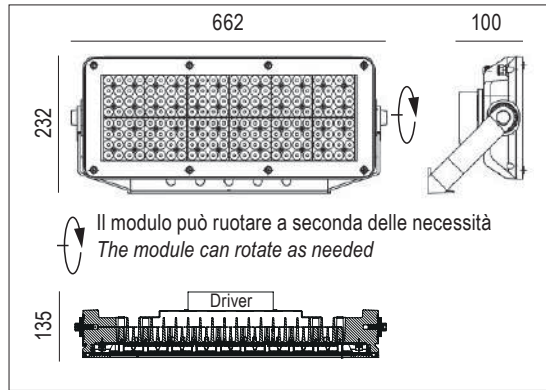

colour	W	angle	K	CRI	nominal lm tc = 25°C	lm output	lm/W	pcs	Kg	CELL
G	400	15°	4000	80	65.500	58.000	145	1	11,00	MI-400-15-4K
G	400	25°	4000	80	65.500	58.000	145	1	11,00	MI-400-25-4K
G	400	40°	4000	80	65.500	58.000	145	1	11,00	MI-400-40-4K
G	400	ASY	4000	80	65.500	58.000	145	1	11,00	MI-400-ASY-4K
G	400	15°	5700	90	65.500	58.000	145	1	11,00	MI-400-15-6K
G	400	25°	5700	90	65.500	58.000	145	1	11,00	MI-400-25-6K
G	400	40°	5700	90	65.500	58.000	145	1	11,00	MI-400-40-6K
G	400	ASY	5700	90	65.500	58.000	145	1	11,00	MI-400-ASY-6 K

A richiesta: disponibilità di varie ottiche - On request: availability of various optics

LED Milano Sport 2



colour	W	angle	K	CRI	nominal lm tc = 25°C	lm output	lm/W	pcs	Kg	CELL
G	600	15°	4000	80	98.300	87.000	145	1	25,00	MI-600-15-4K
G	600	25°	4000	80	98.300	87.000	145	1	25,00	MI-600-25-4K
G	600	40°	4000	80	98.300	87.000	145	1	25,00	MI-600-40-4K
G	600	ASY	4000	80	98.300	87.000	145	1	25,00	MI80ASY4K600W
G	600	15°	5700	90	98.300	87.000	145	1	25,00	MI-600-15-6K
G	600	25°	5700	90	98.300	87.000	145	1	25,00	MI-600-25-6K
G	600	40°	5700	90	98.300	87.000	145	1	25,00	MI-600-40-6K
G	600	ASY	5700	90	98.300	87.000	145	1	25,00	MI-600-ASY-6K
G	800	15°	4000	80	131.000	116.000	145	1	25,00	MI-800-15-4K
G	800	25°	4000	80	131.000	116.000	145	1	25,00	MI-800-25-4K
G	800	40°	4000	80	131.000	116.000	145	1	25,00	MI-800-40-4K
G	800	ASY	4000	80	131.000	116.000	145	1	25,00	MI-800-ASY-4K
G	800	15°	5700	90	131.000	116.000	145	1	25,00	MI-800-15-6K
G	800	25°	5700	90	131.000	116.000	145	1	25,00	MI-800-25-6K
G	800	40°	5700	90	131.000	116.000	145	1	25,00	MI-800-40-6K
G	800	ASY	5700	90	131.000	116.000	145	1	25,00	MI-800-ASY-6K

A richiesta: disponibilità di varie ottiche - On request: availability of various optics

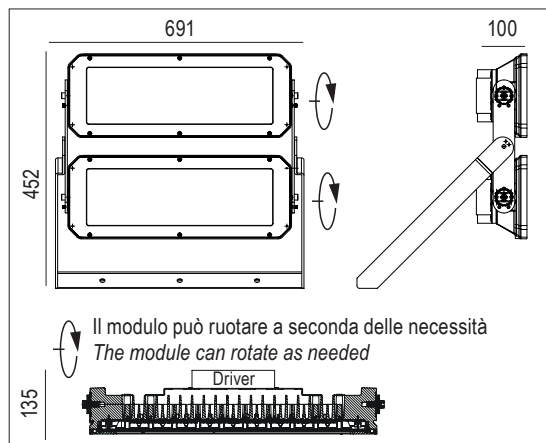

LED Milano Sport 3

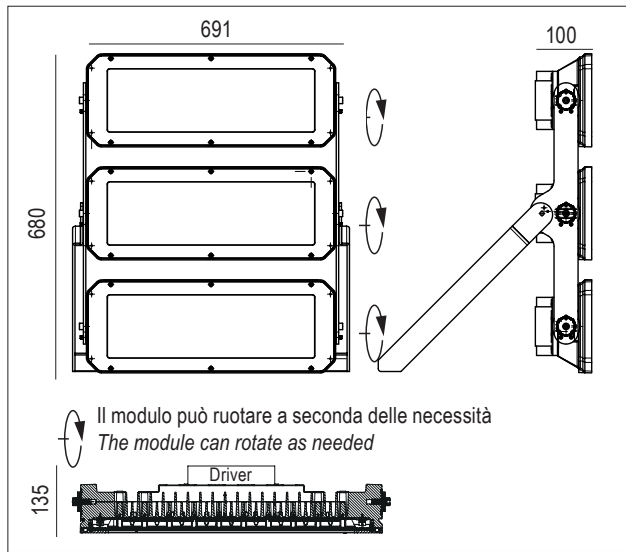

colour	W	angle	K	CRI	nominal lm tc = 25°C	lm output	lm/W	pcs	Kg	CELL
G	1.200	15°	4000	80	196.600	174.000	145	1	42,00	MI-1200-154K
G	1.200	25°	4000	80	196.600	174.000	145	1	42,00	MI-1200-254K
G	1.200	40°	4000	80	196.600	174.000	145	1	42,00	MI-1200-404K
G	1.200	ASY	4000	80	196.600	174.000	145	1	42,00	MI-1200-ASY4K
G	1.200	15°	5700	90	196.600	174.000	145	1	42,00	MI-1200-156K
G	1.200	25°	5700	90	196.600	174.000	145	1	42,00	MI-1200-256K
G	1.200	40°	5700	90	196.600	174.000	145	1	42,00	MI-1200-406K
G	1.200	ASY	5700	90	196.600	174.000	145	1	42,00	MI-1200-ASY6K

A richiesta: disponibilità di varie ottiche - **On request:** availability of various optics

Ottiche di serie - Standard optics

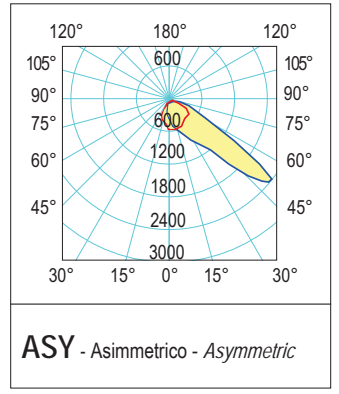
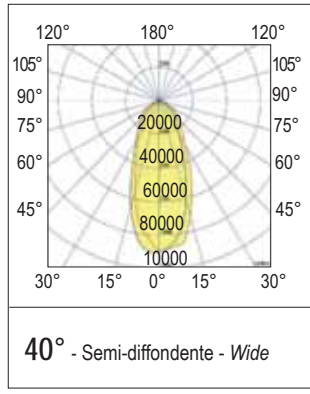
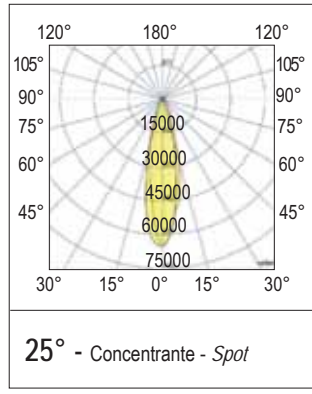
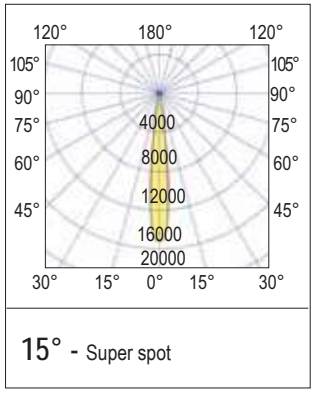

Applicazioni - Applications

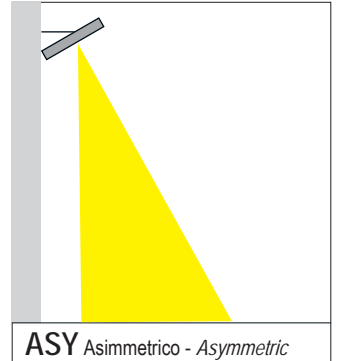
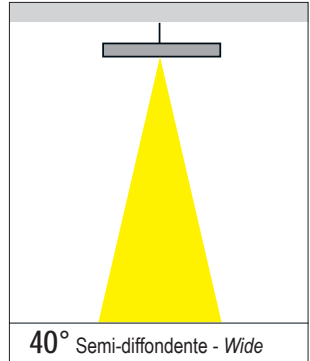
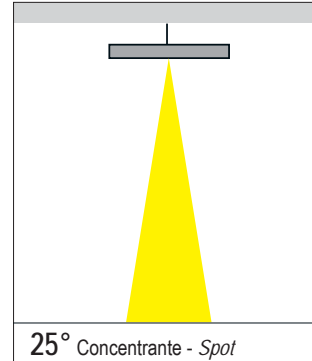
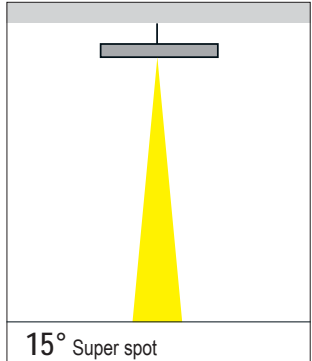

LED Milano Sport

Luce di alta qualità per riprese TV in HD - High quality light for HD TV shoots

Alluminio di elevata purezza
High purity aluminium

Vetro ultra bianco
Ultra-white glass

Accessorio puntatore laser
Laser pointer accessory
Code: 35500/LAS

Accessorio staffa testa palo
Pole head bracket accessory
Code: 35500/STF

Staffa di fissaggio ruotabile con goniometro.
Doppia vite blocca-staffa per resistenza al vento.
Rotating support with goniometer and double bracket blocking screws against the wind.

Sul retro di LED Sports alette di raffreddamento maggiorate.
LED Sports on the back is provided with increased cooling fins.

Quando guardiamo una trasmissione televisiva, può capitare di notare un fastidioso sfarfallio durante la riproduzione delle immagini a rallentatore. Il fenomeno, detto anche "flicker", affatica la vista e distrae il telespettatore soprattutto durante la riprese a "moviola". Le cause dello sfarfallio possono variare in base alla frequenza della modulazione, la fluttuazione di tensione ed il numero di fotogrammi al secondo. Generalmente uno sfarfallio inferiore al 5% non da alcun fastidio durante le riprese a "moviola" fino a 150 fotogrammi al secondo. Un sistema di illuminazione con un fattore di sfarfallio (FF) inferiore a 5% è in grado di eliminare lo sfarfallio percepito in quasi tutte le frequenze dei fotogrammi utilizzate nelle riprese sportive.

During a broadcast it is not uncommon to perceive an annoying flicker especially during slow motion. This flicker is distracting and should be eliminated where possible. The circumstances that produce the flicker vary upon the frequency modulation, voltage and camera frame rate. The table below provides a general rule of flicker factor values produced by various lighting systems. A flicker factor of less than 5% will generally not cause problems for slow motion replays at up to 150 frames per second. A lighting system with a flicker factor of less than 5% will eliminate the perceived flicker at most frame rates per second used within the sports television industry. The acceptable level of flicker factor (FF) is indicated in the Illuminance Category Tables.

Floodlight



LED Milano Sport

Dettagli e accessori inclusi - Details and included accessories



Il sistema di dissipazione del calore è appositamente realizzato per permettere il funzionamento dei LED con temperature idonee e garantire ottime prestazioni/rendimento ed un'elevata durata.

The heat dissipation system is designed to permit use of the LEDs at suitable temperatures and to guarantee excellent efficiency/performance and a long lifespan.

Completo di staffa e goniometro con scala graduata posta su entrambi i lati per il perfetto puntamento del proiettore. È possibile inoltre la regolazione dell'inclinazione di ogni singolo modulo con un range di orientamento pari a +20° e -20° rispetto alla posizione 0 (orizzontale).

Goniometric scale for perfect pointing of the projector. Graduated scale on both sides. Each module can also be tilted at an angle between +20° and -20° in relation to position 0 (horizontal).



LED Milano Sport 1 verrà fornito provvisto di N° 2 driver (IP67). Alimentazione 100-240V.

LED Milano Sport 1 is supplied with 2 drivers (IP67). 100-240V power supply.

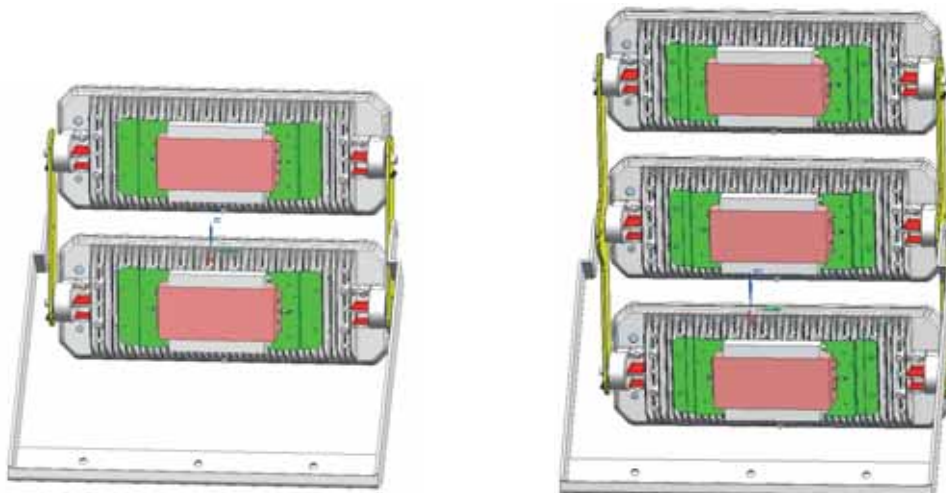



La certificazione fotometrica dei nostri apparecchi viene sempre effettuata da un istituto esterno. Efficienza luminosa e "lm Output" sono quindi il risultato di tale istituto.

The photometric certification of our appliances is always carried out by an external institute. Luminous efficiency and "lm Output" are therefore the result of this institute.

1-10Vdc



DMX

Wireless

Il LED Milano Logistica è un proiettore adatto per l'illuminazione di stabilimenti di produzione, magazzini e depositi. La particolare forma permette di avere diverse potenze e fasci luminosi stretti e precisi, specifici per l'installazione a notevole altezza. La qualità delle parti elettroniche, del corpo lampada e dei materiali assicurano sicurezza in fase di esercizio nelle condizioni ambientali più critiche.

Installazione: sospensione (con ganci), parete plafone (con staffa)

Corpo e telaio: alluminio pressofuso

Staffa di fissaggio: in acciaio zincato a caldo, con goniometro graduato per un corretto puntamento del fascio luminoso

Verniciatura: speciale eseguita a polvere, resistente agli agenti atmosferici e alla corrosione e alle nebbie. Colore Grigio RAL 9007.

Ottica: in policarbonato metallizzato

Schermo: vetro temperato ultra-white resistente agli shock termici e agli urti h 4mm

Sorgente: LED

Mantenimento del flusso luminoso minimo al 70%: 80.000h (L70B20) per l'80% dei LED.

Temperatura di colore: 4000K (CRI 80). A richiesta 5700K (CRI 90);

Driver LED multipotenza:

Certificato

Fattore di potenza: $\geq 0,9$

Protezione: 5/10kV

Norme di riferimento

EN60598-1; EN60598-2-1; EN62471; EN62031

EN60598-2-5; EN61547

The Milano Logistica LED is a projector suitable for lighting production plants, warehouses and warehouses.

Different light intensities and narrow and precise light beams are possible due to the special design of the lamp body and light source, specifically for installation at a considerable height. The quality of the electronic parts, lamp body and materials ensure operating safety under even the most critical of environmental conditions.

Installation: suspension (with hooks), wall ceiling (with bracket)

Housing and frame: die-cast aluminium

Fitting stirrup: in hot galvanised steel with graduated goniometer for correct pointing of the light beam

Painting: special powder coating, resistant to atmospheric agents, corrosion and mists. Grey RAL 9007.

Optic: in metallized polycarbonate

Screen: ultra-white tempered glass resistant to thermal shocks and impacts h 4mm

Source: LED

Maintenance of 70% minimum luminous flux: 80,000h (L70B20) for 80% of the LEDs.

Color temperature: 4000K (CRI 80). On demand 5700K (CRI 90);

Driver LED:

Certified

Power factor: $\geq 0,9$

Surge protection: 5/10kV

Standard reference

EN60598-1; EN60598-2-1; EN62471; EN62031

EN60598-2-5; EN61547

100-240 Vac	50/60 Hz	IP66	IK08	CRI > 80	+50 C° -20	850°		CE	 pending		
	RG0	LOW FLICKER	Driver included RIPPLE FREE								

LED Milano Logistica

Accessori inclusi - Included accessories

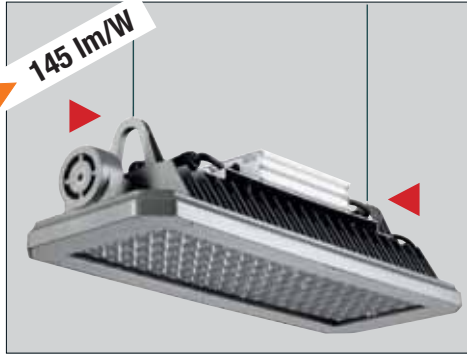

Dimensioni (mm) taffa di fissaggio
Mounting bracket dimensions (mm)

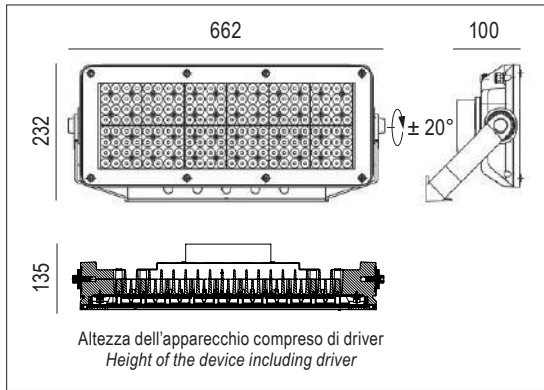
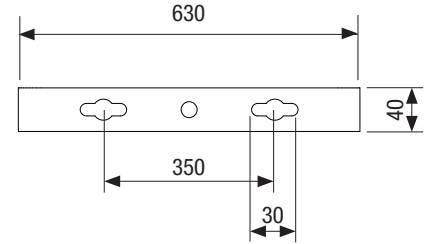

colour	W	angle	K	CRI	nominal lm tc = 25°C	lm output	lm/W	pcs	Kg	CELL
G	200	50°	4000	80	32.800	29.000	145	1	11,00	MIL20050-4K
G	200	90°	4000	80	32.800	29.000	145	1	11,00	MIL20090-4K
G	200	ELLIP	4000	80	32.800	29.000	145	1	11,00	MIL200EL-4K
G	250	50°	4000	80	38.000	33.750	135	1	11,00	MIL25050-4K
G	250	90°	4000	80	38.000	33.750	135	1	11,00	MIL25090-4K
G	250	ELLIP	4000	80	38.000	33.750	135	1	11,00	MIL250EL-4K
G	300	50°	4000	80	44.000	39.000	130	1	11,00	MIL30050-4K
G	300	90°	4000	80	44.000	39.000	130	1	11,00	MIL30090-4K
G	300	ELLIP	4000	80	44.000	39.000	130	1	11,00	MIL300EL-4K
G	400	50°	4000	80	54.200	48.000	120	1	11,00	MIL40050-4K
G	400	90°	4000	80	54.200	48.000	120	1	11,00	MIL40090-4K
G	400	ELLIP	4000	80	54.200	48.000	120	1	11,00	MIL400EL-4K

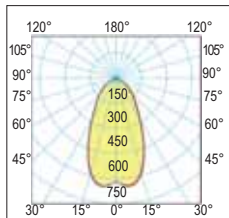

50° - Intermedio - Medium

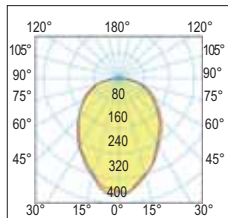

90° - Diffondente - Wide

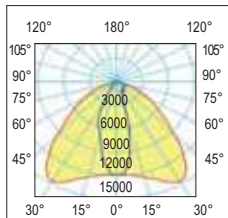

ELLIP
Ellittica - Elliptical



Esempio applicativo Installazione su corpo illuminante con sensore a richiesta

Application example Installation on lighting body with sensor on demand



Ampiezza rilevamento
Detection width

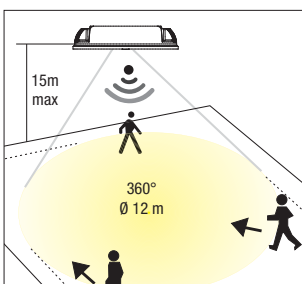
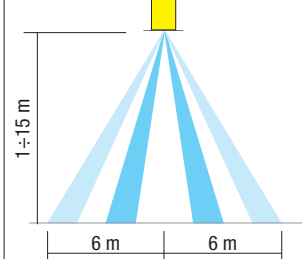

LED Milano Logistica a richiesta può essere fornito in versione EMERGENZA 2h 6W o 3h 3W

On request, LED Milano Logistica are can be supplied in an EMERGENCY version



LED Allegra Plus

130 - 140 Lm/W

Waterproof luminaires

La certificazione fotometrica dei nostri apparecchi viene sempre effettuata da un istituto esterno. Efficienza luminosa e "lm Output" sono quindi il risultato di tale istituto.

The photometric certification of our appliances is always carried out by an external institute. Luminous efficiency and "lm Output" are therefore the result of this institute.

A richiesta - On demand



Sensor DIM
1-10V

Sensor DIM
DALI

Apparecchi di illuminazione a LED per applicazioni a luce diffusa da interno e da esterno. Le elevate prestazioni illuminotecniche consentono a questi apparecchi di illuminazione di poter essere collocati in molteplici campi applicativi quali ad esempio, aree comuni, negozi, magazzini anche dove sia richiesto un elevato indice di protezione alle polveri (6), all'acqua (5) ed agli urti (8).

Installazione: a soffitto o a sospensione

Corpo: in policarbonato grigio infrangibile stabilizzato ai raggi UV. Colore Grigio RAL 7038

Ganci e viteria: in acciaio Inox

Cavo: privo di alogenuri

Diffusore: in policarbonato semi-opale di ottima qualità, autoestinguento V2 stabilizzato ai raggi UV

Conforme alla norma: EN62471: 2008, sicurezza fotobiologica delle lampade e sistemi di lampade.

Driver: incluso nel sistema > 50.000 h
Fattore di potenza $\geq 0,95$.

Sorgente: LED LG. Mantenimento del flusso luminoso minimo al 80% - 80.000h (L80B20).

Temperatura di colore: 4000K. Altre temperature di colore a richiesta (2200K - 2700K - 3000K - 5000K - Consegna: 60 giorni).

A richiesta: con rilevatore di movimento a microonde con crepuscolare - Cod. BC360A-D02 (Vedi Pag. 51)

Norme di riferimento
EN60598-1; EN60598-2-1; EN62471
EN62031; EN60598-2-5; EN61547

LED lighting fixtures for indoor and outdoor diffused light applications. Thanks to their high lighting performance, these fixtures can be used in a number of applications, such as common areas, shops and warehouses but also where high protection from dust (6), water (5) and shocks (8) is required.

Installation: ceiling or suspended

Housing: high quality semi-opal polycarbonate, self-extinguishing V2 stabilized against UV rays. Grey RAL 7038

Hooks and screw: in stainless steel

Cable: halogen free

Diffuser: made by semi-opal polycarbonate

Complying to standard: EN62471: 2008, photobiological safety of lamps and lamp systems

*Driver: included included in the system > 50.000 h
Power factor $\geq 0,95$.*

Source: LED LG. Maintenance of minimum luminous flux to 80% - 80.000h (L80B20).

Color temperature: 4000K. (other color temperatures on demand (2200K - 2700K - 3000K - 5000K - Delivery time: 60 days).

On demand: with microwave motion detector with crepuscular - Cod. BC360A-D02 (see Pag. 51)

Standard references
EN60598-1; EN60598-2-1; EN62471
EN62031; EN60598-2-5; EN61547

220-240 Vac	50/60 Hz	110 Vac On demand	IP66	IK09	IK10 A richiesta On demand	CRI > 80	+40 C -20	CE	ELC 17	
850°		TECEE	RG0	LOW FLICKER	Driver included	MULTIPOWER				

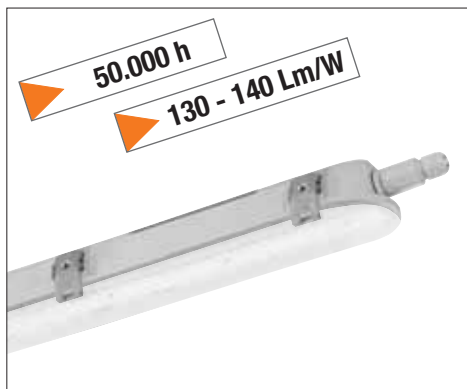

colour	W	L (mm)	Optic	K	lm output	lm/W	pcs	Kg	CELL
G	20	680	110°	4000	2800	140	1	2,50	32003/H
G	24	1220	110°	4000	3360	140	1	2,10	32001/H
G	36	1220	110°	4000	5040	140	1	2,10	32002/H
G	45	1220	110°	4000	6300	140	1	2,10	32030/H
G	54	1560	110°	4000	7020	130	1	5,46	32031/H
G	54	1560	110°	5000	7020	130	1	5,46	32033/H
G	65	1560	110°	4000	8450	130	1	5,46	32031/60/H

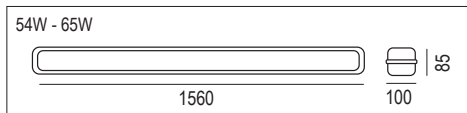
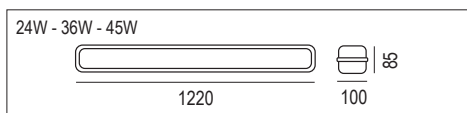
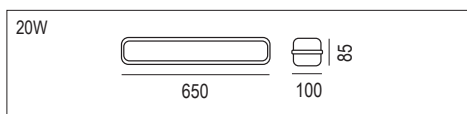

AUTOTEST (Vedi Pag. 68 - See Page 68)									
colour	W	L (mm)	Optic	K	lm output	lm/W	pcs	Kg	CELL-E
G	20	680	110°	4000	2800	140	1	2,50	32003/H/EMER
G	24	1220	110°	4000	3360	140	1	2,10	32001/H/EMER
G	36	1220	110°	4000	5040	140	1	2,10	32002/H/EMER
G	45	1220	110°	4000	6300	140	1	2,10	32030/H/EMER
G	54	1560	110°	4000	7020	130	1	5,46	32031/H/EMER
G	65	1560	110°	4000	8450	130	1	5,46	32031/60/H/EM



AUTOESTINGUENZA: LED Allegra Plus è realizzata in un materiale plastico in classe V2. Con questo materiale il corpo lampada si spegnerà entro 25".

FILO INCANDESCENTE: LED Allegra Plus è resistente alla prova del filo incandescente per 850°C.

SELF-EXTINGUISHING: LED Allegra Plus is made of a plastic material in class V2. With this material the specimen will turn off within 25".

INCANDESCENT WIRE: LED Allegra Plus is resistant to the glow wire test for 850 °C.

1-10Vdc									
colour	W	L (mm)	Optic	K	lm output	lm/W	pcs	Kg	CELL
G	24	1220	110°	4000	3360	140	1	2,10	32001/H/S10
G	36	1220	110°	4000	5040	140	1	2,10	32002/H/S10
G	45	1220	110°	4000	6300	140	1	2,10	32030/H/S10
G	54	1560	110°	4000	7020	130	1	5,46	32031/H/S10
G	65	1560	110°	4000	8450	130	1	5,46	32031/60/H/10

AUTOTEST (Vedi Pag. 68 - See Page 68) 1-10Vdc									
colour	W	L (mm)	Optic	K	lm output	lm/W	pcs	Kg	CELL-E
G	45	1220	110°	4000	6300	140	1	2,10	32030/H/EM/10
G	54	1560	110°	4000	7020	130	1	5,46	32031/H/EM/10

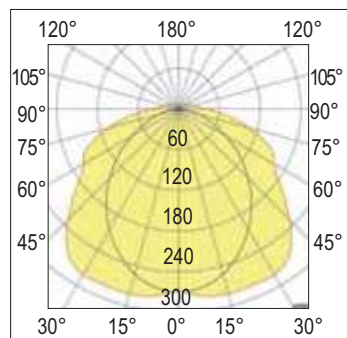

DALI 2									
colour	W	L (mm)	Optic	K	lm output	lm/W	pcs	Kg	CELL
G	24	1220	110°	4000	3360	140	1	2,10	32001/H/DALI
G	36	1220	110°	4000	5040	140	1	2,10	32002/H/DALI
G	45	1220	110°	4000	6300	140	1	2,10	32030/H/DALI
G	54	1560	110°	4000	7020	130	1	5,46	32031/H/DALI
G	65	1560	110°	4000	8450	130	1	5,46	32031/60/H/DA

AUTOTEST (Vedi Pag. 68 - See Page 68) DALI 2									
colour	W	L (mm)	Optic	K	lm output	lm/W	pcs	Kg	CELL-E
G	24	1220	110°	4000	3360	140	1	2,10	32001/H/EM/DA
G	45	1220	110°	4000	6300	140	1	2,10	32030/H/EM/DA
G	54	1560	110°	4000	7020	130	1	5,46	32031/H/EM/DA

VANTAGGI EMERGENZA CON AUTOTEST - ADVANTAGES OF EMERGENCY WITH SELF-TEST

Il modello Autotest segnala eventuali anomalie (attraverso il Led bicolore Rosso-Verde) che possono presentarsi durante il normale funzionamento della batteria e/o circuito di pilotaggio della lampada a cui è collegato l'inverter

The Autotest model signals any anomalies (through the two-colour Red-Green LED) that may occur during normal operation of the battery and/or piloting circuit of the lamp to which the inverter is connected

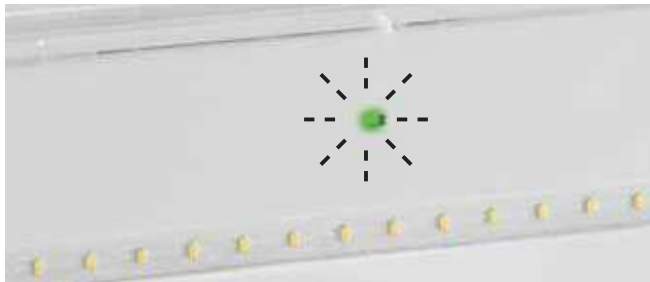

Colore LED - LED indication	Stato - Status
Verde fisso - Permanent Green	Batteria carica o in carica - Battery charge or charging
Verde lampeggiante - Flashing Green	Funzione TEST avviata - TEST in progress
Verde lampeggiante lento (1s ON - 1s OFF) Slow flashing green (1s ON - 1s OFF)	TEST di autonomia avviato - Autonomy TEST in progress
Rosso fisso - Permanent Red	Lampada guasta - Lamp failure
Rosso lampeggio veloce (0,1s ON - 0,1s OFF) Fast flashing Red (0,1s ON - 0,1s OFF)	Guasto circuito di ricarica - Charging failure
Lampeggio Rosso lento (1s ON - 1s OFF) Slow flashing Red (1s ON - 1s OFF)	Batteria guasta - Battery failure
Verde e Rosso OFF - Green and Red OFF	Emergenza ON - Emergency ON

A richiesta - On demand Emergency

Con cablaggio in emergenza ad alimentazione centralizzata. Apparecchio permanente, con alimentatore funzionante AC/DC, alimentato da un sistema di emergenza centralizzato, cioè non incorporato nell'apparecchio.

With centralized emergency wiring. Permanent device, with AC / DC power supply, powered by a centralized emergency system, i.e. not incorporated into the device



Connettore rapido incluso in tutti i modelli
Included fast connection in all models

LED Allegra Plus - Connettore 2 poli - 2 pole connections



LED Allegra Plus - Connettore 4 poli - 4 pole connections

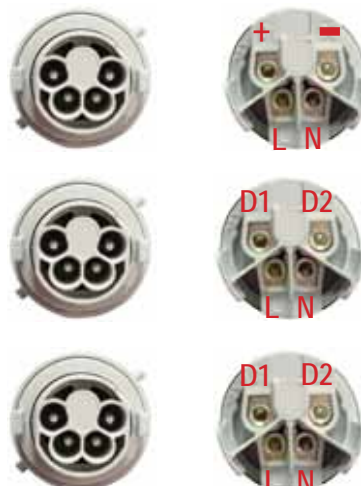

1-10Vdc

DALI 2

 Emergency

LED Allegra Plus

A richiesta: LED Allegra Plus con linea passante (aggiungere /S dopo il codice) - Upon request: LED Allegra Plus with through-wiring (add /S after the code)

N° massimo di apparecchi collegabili per ogni linea elettrica Maximum number of devices that can be connected to any electrical line	
W Potenza - Power	N° massimo di apparecchi Maximum number of device
24	65
36	40
45	30
54	26
65	20



N.B. Corrente di spunto = 25A per 200µs per ogni apparecchio
N.B. Inrush current = 25A for 200µs each

Prezzo: + 10,00 Euro al prezzo lordo standard di listino
Price: + 10,00 Euros to the list price

Accessori inclusi - Included accessories



Staffa di fissaggio a parete/plafone in acciaio inox. Tasselli e viti non compresi. Per l'installazione a parete o soffitto utilizzare tasselli e viti adeguati alla superficie su cui andrà ancorata.

Wall/ceiling fixing bracket made by stainless steel. Plug and screws are not included. For ceiling or wall installation use plug and screws adapted to surface upon which it will be anchored.



Kit per montaggio a parete/plafone e sospensione
Wall/Ceiling and suspension mounting kit

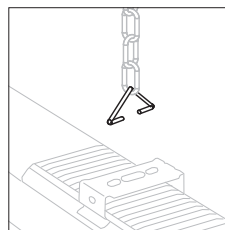

NON incluso - NOT included

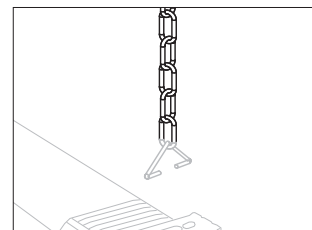

Cod. 000150
Catena 1m per montaggio a sospensione
Suspension assembly chain (1m)

Luce solo all'occorrenza - Light only when needed

A richiesta - On demand



Rilevatore di MOVIMENTO a microonde con crepuscolare per impostazione soglia Lux ambiente di intervento, questa tecnologia consente di "nascondere" il rilevatore anche all'interno di corpi lampada infatti esso emette onde elettromagnetiche ad alta frequenza (5,8GHz) e riceve il loro eco, in questo modo è in grado di riconoscere una qualsiasi variazione data da un oggetto non rilevato nella precedente analisi e verrà dato il comando di ON. La trasmissione ad alta frequenza è <10mW e risulta essere 100 volte inferiore alle emissioni di un comune telefono cellulare o di un forno a microonde che emettono mediamente 1000mW.

Installazione: da incorporare
Controllo di luminosità: 10-300 lux 24h
Trasmissione di segnale: <10mW
Consumo: ± 0,9W
Sensibilità: 2÷10m
Tempo: 10 sec + 30 min
Angolo di rilevamento: 360°

Per ulteriori informazioni vedi Pag. 80

Microwave MOTION detector with crepuscular. This technology allows the detector to be "hidden" within lamp bodies, in fact it emits electromagnetic waves at a high frequency (5.8GHz) and receives their echoes. In this way, it can recognise any variation given by an object not detected in the previous analysis and the ON command will be given. High frequency transmission is <10mW and is 100 times lower than the emissions of a common mobile phone or a microwave oven emitting an average of 1000mW.

Installation: built-in use
Light control: 10-300 lux 24h
Transmission power: <10mW
Power consumption: ± 0,9W
Sensitivity: 2÷10m
Time: 10 sec + 30 min
Angle detection: 360°

For further information see page 80

Settaggio di fabbrica - Factory setting

Sensibilità - Sensibility	10 m
Tempo - Time	Ritardato 10s - 10s delayed
Luminosità - Luminosity	200 Lux



Versione con sensore di rilevamento a distanza Radar Control ON/OFF. Aggiungere Y dopo il codice - es. 32030/HY. Più Euro 30,00 dal prezzo di listino

Version with remote detection sensor Radar control ON/OFF. Add Y after the code - ex. 32030/HY). + 30,00 Euros from the list price



Apparecchi di illuminazione a LED per applicazioni a luce diffusa da interno e da esterno. Le elevate prestazioni illuminotecniche consentono a questi apparecchi di illuminazione di poter essere collocati in molteplici campi applicativi quali ad esempio, aree comuni, negozi, magazzini anche dove sia richiesto un elevato indice di protezione alle polveri, all'acqua ed agli urti.

Installazione: a soffitto o a sospensione

Corpo: in policarbonato grigio infrangibile stabilizzato ai raggi UV.

Viteria: in acciaio Inox

Ganci: Poliammide + fibra di vetro

Cavo: privo di alogenuri

Diffusore: in policarbonato opale di ottima qualità, autoestinguente V2 stabilizzato ai raggi UV

Conforme alla norma: EN62471: 2008, sicurezza fotobiologica delle lampade e sistemi di lampade.

Driver: incluso nel sistema > 50.000 h
Fattore di potenza $\geq 0,95$.

Sorgente: LED **SAMSUNG**. Mantenimento del flusso luminoso minimo al 90% - 50.000h (L90B10).

Temperatura di colore: 4000K

Norme di riferimento
EN60598-1; EN60598-2-1; EN62471
EN62031; EN60598-2-5; EN61547

LED lighting fixtures for indoor and outdoor diffused light applications. Thanks to their high lighting performance, these fixtures can be used in a number of applications, such as common areas, shops and warehouses but also where high protection from dust water and shocks is required.

Installation: ceiling or suspended

Housing: high quality semi-opal polycarbonate, self-extinguishing V2 stabilized against UV rays

Screw: in stainless steel

Hooks: Polyamide + glass fiber

Cable: halogen free

Diffuser: made by semi-opal polycarbonate

Complying to standard: EN62471: 2008, photobiological safety of lamps and lamp systems

*Driver: included included in the system > 50.000 h
Power factor $\geq 0,95$.*

Source: LED LG. Maintenance of minimum luminous flux to 90% - 50.000h (L90B10).

Color temperature: 4000K

Standard references
EN60598-1; EN60598-2-1; EN62471
EN62031; EN60598-2-5; EN61547

220-240 Vac	50/60 Hz	IP66	IK08	CRI > 80	+45 C° -25	CE		850°	
----------------	-------------	------	------	-------------	------------------	----	--	------	--

Driver included

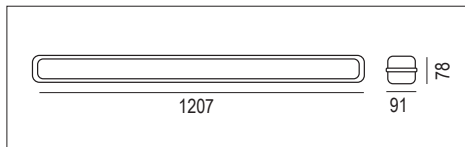
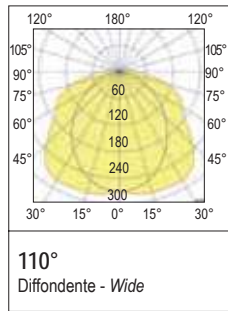

colour	W	Optic	K	lm output	lm/W	pcs	Kg	CELL
G	max 42	110°	4000	max 5.460	130	1	2,50	32030/C

AUTOTEST (Vedi Pag. 68 - See Page 68)

colour	W	Optic	K	lm output	lm/W	pcs	Kg	CELL-E
G	max 42	110°	4000	max 5.460	130	1	2,50	32030/C/EM

Flusso/potenza regolabili manualmente su 4 step - Flux / power manually adjustable on 4 steps

LED Driver multipotenza incluso
LED Driver multipower included

I mA	W
200	18
250	24
300	36
350	42
	Taratura di fabbrica Factory setting



Per una corretta gestione dell'impianto di illuminazione, bisogna sempre tenere conto sia della necessità di illuminamento realizzato tramite calcolo illuminotecnico, che il rispetto dei consumi energetici.

I nostri modelli LED Allegra Basic permettono di ottenere questo risultato poiché sono dotati di Driver multipower; questi particolari Driver consentono di impostare la corrente in uscita tramite dip-switch, fornendo, di conseguenza, la corretta potenza di lampada in base all'esigenza desiderata, permettendo quindi sia il risparmio energetico che il rispetto del flusso luminoso determinato in fase di progetto.

For proper management of the lighting system, it is always necessary to take into account both the need for lighting achieved through lighting engineering calculations, and respect for energy consumption.

Our Allegra Basic LED models allow to obtain this result as they are equipped with multipower Driver; these particular drivers allow you to set the output current via dip-switches, thus providing the correct lamp power based on the desired need, thus allowing both energy savings and respect for the luminous flux determined in the design phase.

Accessori inclusi - Included accessories



Staffa di fissaggio a parete/plafone in acciaio inox. Tasselli e viti non compresi. Per l'installazione a parete o soffitto utilizzare tasselli e viti adeguati alla superficie su cui andrà ancorata.

Wall/ceiling fixing bracket made by stainless steel. Plug and screws are not included. For ceiling or wall installation use plug and screws adapted to surface upon which it will be anchored.

Accessori NON inclusi - NOT included accessories

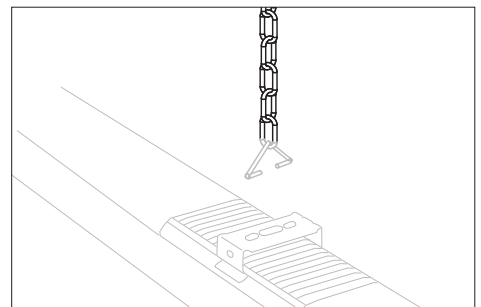

Cod. 000150
Catena 1m per montaggio a sospensione
Suspension assembly chain (1m)

Waterproof luminaires



Apparecchi di illuminazione a LED per applicazioni a luce diffusa da interno e da esterno. Le elevate prestazioni illuminotecniche consentono a questi apparecchi di illuminazione di poter essere collocati in molteplici campi applicativi quali ad esempio, aree comuni, negozi, magazzini anche dove sia richiesto un elevato indice di protezione alle polveri, all'acqua ed agli urti.

Installazione: a soffitto o a sospensione

Corpo: in policarbonato grigio infrangibile stabilizzato ai raggi UV.

Viteria: in acciaio Inox

Ganci: Poliammide + fibra di vetro

Cavo: privo di alogenuri

Diffusore: in policarbonato opale di ottima qualità, autoestinguente V2 stabilizzato ai raggi UV

Conforme alla norma: EN62471: 2008, sicurezza fotobiologica delle lampade e sistemi di lampade.

Driver: incluso nel sistema > 50.000 h

Fattore di potenza $\geq 0,95$.

Sorgente: LED **SAMSUNG**. Mantenimento del flusso luminoso minimo al 90% - 50.000h (L90B10).

Temperatura di colore: 4000K

Norme di riferimento

EN60598-1; EN60598-2-1; EN62471

EN62031; EN60598-2-5; EN61547

LED lighting fixtures for indoor and outdoor diffused light applications. Thanks to their high lighting performance, these fixtures can be used in a number of applications, such as common areas, shops and warehouses but also where high protection from dust water and shocks is required.

Installation: ceiling or suspended

Housing: high quality semi-opal polycarbonate, self-extinguishing V2 stabilized against UV rays

Screw: in stainless steel

Hooks: Polyamide + glass fiber

Cable: halogen free

Diffuser: made by semi-opal polycarbonate

Complying to standard: EN62471: 2008, photobiological safety of lamps and lamp systems

Driver: included in the system > 50.000 h

Power factor $\geq 0,95$.

Source: LED LG. Maintenance of minimum luminous flux to 90% - 50.000h (L90B10).

Color temperature: 4000K

Standard references

EN60598-1; EN60598-2-1; EN62471

EN62031; EN60598-2-5; EN61547

A richiesta - On demand



Emergency

Con cablaggio in emergenza ad alimentazione centralizzata. Apparecchio permanente, con alimentatore funzionante AC/DC, alimentato da un sistema di emergenza centralizzato, cioè non incorporato nell'apparecchio

With centralized emergency wiring. Permanent device, with AC / DC power supply, powered by a centralized emergency system, i.e. not incorporated into the device

220-240 Vac	50/60 Hz	IP66	IK10	CRI > 80	+45 C° -25	CE	17		850°		
----------------	-------------	------	------	-------------	------------------	----	----	--	------	--	--

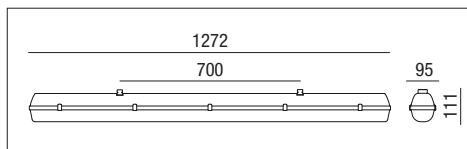
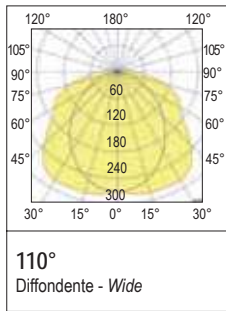

colour	W	Optic	K	lm output	lm/W	pcs	Kg	CELL
G	max 45	110°	4000	5.895	131	1	3,20	32030/G
G	max 45	110°	4000	5.895	131	1	3,20	32030/G/EMER



DALI 2								
colour	W	Optic	K	lm output	lm/W	pcs	Kg	CELL
G	max 45	110°	4000	5.895	131	1	3,20	32030/G/DALI
G	max 45	110°	4000	5.895	131	1	3,20	32030/G/EM/DA

Flusso/potenza regolabili manualmente - Flux / power manually adjustable

LED Driver multipotenza incluso LED Driver multipower included	
I mA	W
200	24
300	36
350	45
Taratura di fabbrica Factory setting	



Per una corretta gestione dell'impianto di illuminazione, bisogna sempre tenere conto sia della necessità di illuminamento realizzato tramite calcolo illuminotecnico, che il rispetto dei consumi energetici. I nostri modelli LED Gioia permettono di ottenere questo risultato poiché sono dotati di Driver multipower; questi particolari Driver consentono di impostare la corrente in uscita tramite dip-switch, fornendo, di conseguenza, la corretta potenza di lampada in base all'esigenza desiderata, permettendo quindi sia il risparmio energetico che il rispetto del flusso luminoso determinato in fase di progetto.

For proper management of the lighting system, it is always necessary to take into account both the need for lighting achieved through lighting engineering calculations, and respect for energy consumption. Our LED Gioia models allow to obtain this result as they are equipped with multipower Driver; these particular drivers allow you to set the output current via dip-switches, thus providing the correct lamp power based on the desired need, thus allowing both energy savings and respect for the luminous flux determined in the design phase.

Accessori inclusi - Included accessories



Staffa di fissaggio a parete/plafone in acciaio inox. Tasselli e viti non compresi. Per l'installazione a parete o soffitto utilizzare tasselli e viti adeguati alla superficie su cui andrà ancorata.
Wall/ceiling fixing bracket made by stainless steel. Plug and screws are not included. For ceiling or wall installation use plug and screws adapted to surface upon which it will be anchored.

Accessori NON inclusi - NOT included accessories



Cod. R-90002
Staffa laterale - Side hanger

Waterproof luminaires

LED Felice

80.000 h

140 - 165 Lm/W

Waterproof luminaires

Apparecchi di illuminazione a LED per applicazioni a luce diffusa da interno e da esterno. Le elevate prestazioni illuminotecniche consentono a questi apparecchi di illuminazione di poter essere collocati in molteplici campi applicativi quali ad esempio, aree comuni, negozi, magazzini anche dove sia richiesto un elevato indice di protezione alle polveri (6), all'acqua (6) ed agli urti (8).

Installazione: a soffitto o a sospensione

Corpo: base in plastica rinforzata con vetro GRP (Glass Reinforced Plastic).

Ganci e viteria: in acciaio Inox

Diffusore: in policarbonato trasparente (a richiesta in policarbonato semi opale - aggiungere O dopo il codice). Finitura liscia.

Conforme alla norma: EN62471: 2008, sicurezza fotobiologica delle lampade e sistemi di lampade.

Driver: incluso nel sistema > 50.000 h
Fattore di potenza $\geq 0,95$.

Sorgente: LED **SAMSUNG** 

Mantenimento del flusso luminoso minimo al 80% - 80.000h (L80B20).

Temperatura di colore: 4000K. Altre temperature di colore a richiesta (2200K - 2700K - 3000K - 5000K - Consegna: 60 giorni).

A richiesta: con rilevatore di movimento a microonde con crepuscolare

Norme di riferimento
EN60598-1; EN60598-2-1; EN62471
EN62031; EN60598-2-5; EN61547

LED lighting fixtures for indoor and outdoor diffused light applications. Thanks to their high lighting performance, these fixtures can be used in a number of applications, such as common areas, shops and warehouses but also where high protection from dust (6), water (6) and shocks (8) is required.

Housing: in plastic reinforced with GRP glass (Glass Reinforced Plastic).

Installation: ceiling or suspended

Hooks and screws: in stainless steel

Diffuser: made by transparent polycarbonate (in semi-opal polycarbonate on demand - add O after the code). Smooth finish.

Complying to standard: EN62471: 2008, photobiological safety of lamps and lamp systems

Driver: included included in the system > 50.000 h
Power factor $\geq 0,95$.

Source: LED **SAMSUNG** 

Maintenance of minimum luminous flux to 80% - 80.000h (L80B20).

Color temperature: 4000K. Other color temperatures on demand (220K - 2700K - 3000K - 5000K - Delivery time: 60 days).

On demand: with microwave motion detector with crepuscular

Standard references
EN60598-1; EN60598-2-1; EN62471
EN62031; EN60598-2-5; EN61547

La certificazione fotometrica dei nostri apparecchi viene sempre effettuata da un istituto esterno. Efficienza luminosa e "lm Output" sono quindi il risultato di tale istituto.

The photometric certification of our appliances is always carried out by an external institute. Luminous efficiency and "lm Output" are therefore the result of this institute.

A richiesta - On demand

Sensor 

Sensor DIM
1-10V

Sensor DIM
DALI

220-240 Vac 50/60 Hz 110 Vac On demand IP66 IK08 CRI > 80 +50 C° -20 CE ENEC 17 pending 850°

TECEE RGO LOW FLICKER Driver included MULTIPOWER Driver included RIPPLE FREE

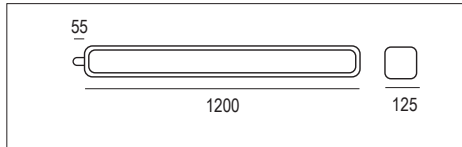
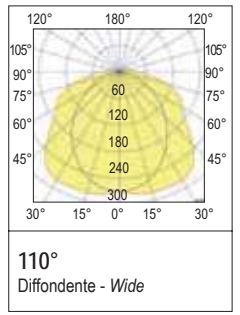
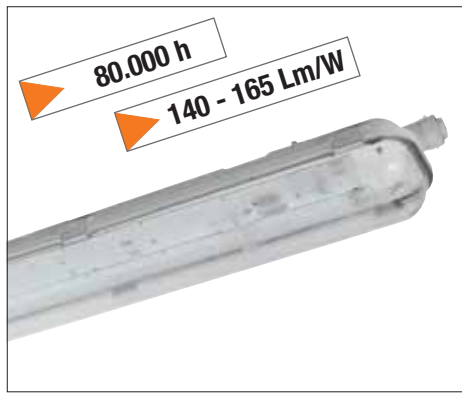

colour	W	Optic	K	lm output	lm/W	pcs	Kg	CELL
G	24	110°	4000	3900	165	1	4,40	32000/F
G	36	110°	4000	6000	165	1	4,40	32001/F
G	45	110°	4000	7400	165	1	4,40	32030/F
G	54	110°	4000	8600	160	1	4,40	32031/F
G	65	110°	4000	9750	160	1	4,40	32031/60/F

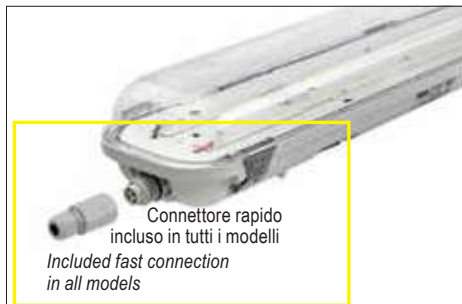

AUTOTEST (Vedi Pag. 68 - See Page 68)

colour	W	Optic	K	lm output	Lm/W	pcs	Kg	CELL-E
G	24	110°	4000	3900	165	1	4,40	32000/F/EMER
G	36	110°	4000	6000	165	1	4,40	32001/F/EMER
G	45	110°	4000	7400	165	1	4,40	32030/F/EMER
G	54	110°	4000	8600	160	1	4,40	32031/F/EMER

LED Felice - Connettore 2 poli - 2 pole connections

LED Felice - Connettore 4 poli - 4 pole connections

1-10Vdc

1-10Vdc

colour	W	Optic	K	lm output	lm/W	pcs	Kg	CELL
G	36	110°	4000	6000	165	1	4,40	32001/F/S10
G	45	110°	4000	7400	165	1	4,40	32030/F/S10
G	54	110°	4000	8600	160	1	4,40	32031/F/S10
G	65	110°	4000	9750	150	1	4,40	32031/60/F/10



AUTOESTINGUENZA: LED Felice è realizzata in un materiale plastico in classe V2. Con questo materiale il corpo lampada si spegnerà entro 25°.

FILO INCANDESCENTE: LED Felice è resistente alla prova del filo incandescente per 850°C.

SELF-EXTINGUISHING: LED Felice is made of a plastic material in class V2. With this material the specimen will turn off within 25°.

INCANDESCENT WIRE: LED Felice is resistant to the glow wire test for 850 °C.

AUTOTEST (Vedi Pag. 68 - See Page 68) **1-10Vdc**

colour	W	Optic	K	lm output	Lm/W	pcs	Kg	CELL-E
G	45	110°	4000	7400	165	1	4,40	32030/F/EM/10
G	54	110°	4000	8600	160	1	5,46	32031/F/EM/10

DALI 2

colour	W	Optic	K	lm output	lm/W	pcs	Kg	CELL
G	24	110°	4000	3900	165	1	4,40	32000/F/DALI
G	36	110°	4000	6000	165	1	4,40	32001/F/DALI
G	45	110°	4000	7400	165	1	4,40	32030/F/DALI
G	54	110°	4000	8600	160	1	4,40	32031/F/DALI
G	65	110°	4000	9750	150	1	4,40	32031/60/F/DA

AUTOTEST (Vedi Pag. 68 - See Page 68) **DALI 2**

colour	W	Optic	K	lm output	Lm/W	pcs	Kg	CELL-E
G	24	110°	4000	3900	165	1	4,40	32000/F/EM/DA
G	36	110°	4000	6000	165	1	4,40	32001/F/EM/DA
G	45	110°	4000	7400	165	1	4,40	32030/F/EM/DA
G	54	110°	4000	8600	160	1	5,46	32031/F/EM/DA

A richiesta: versione AUTOTEST - On demand: AUTOTEST version
 A richiesta: disponibile versione 3000K e 6000K - On demand: for quantity, available 3000K and 6000K version

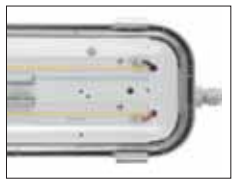

N° 2 strisce LED
N° 2 strip LED

Waterproof luminaires

LED Felice con LENTE - *with LENS*

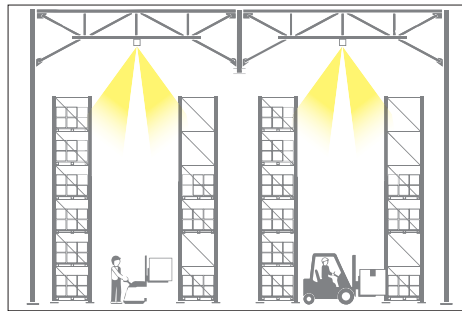
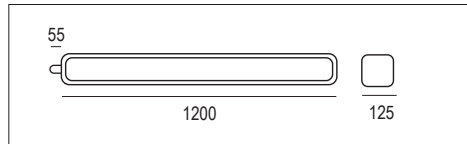
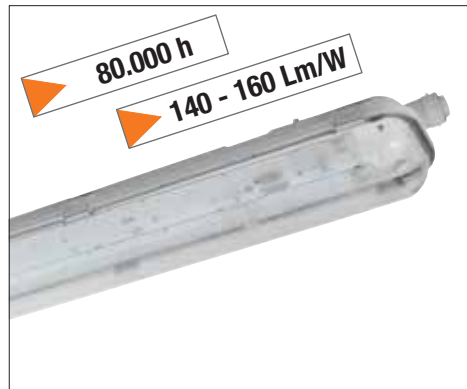

	colour	W	Optic	K	lm output	lm/W	pcs	Kg	CELL
(E)	G	22	ELLIP	4000	3520	160	1	4,40	32000/F-E
(E)	G	36	ELLIP	4000	5580	155	1	4,40	32001/F-E
(E)	G	45	ELLIP	4000	6750	150	1	4,40	32030/F-E
(E)	G	54	ELLIP	4000	7830	145	1	4,40	32031/F-E
(E)	G	65	ELLIP	4000	9440	140	1	4,40	32036/F-E

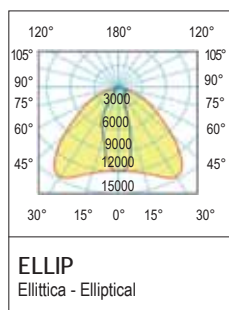

Ottica ellittica 30°x90°
Ideale per l'illuminazione in ambienti con alte scaffalature, in modo da avere una luce diffusa uniformemente
Elliptical optic 30°x90°
Ideal for lighting in environments with very high shelves, so as to have a uniformly diffused light

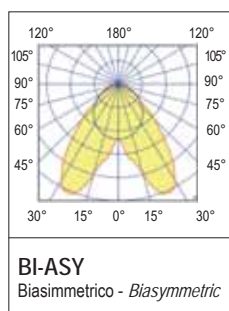

AUTOTEST (Vedi Pag. 68 - See Page 68)

	colour	W	Optic	K	lm output	lm/W	pcs	Kg	CELL
(E)	G	22	ELLIP	4000	3520	160	1	4,40	32000/FEEM
(E)	G	36	ELLIP	4000	5580	155	1	4,40	32001/FEEM
(E)	G	45	ELLIP	4000	6750	150	1	4,40	32030/FEEM
(E)	G	54	ELLIP	4000	7830	145	1	4,40	32031/FEEM
(E)	G	65	ELLIP	4000	9440	140	1	4,40	32036/FEEM

	colour	W	Optic	K	lm output	lm/W	pcs	Kg	CELL
(E)	G	45	BI-ASY	4000	6750	150	1	4,40	32030/F/BIASY
(E)	G	54	BI-ASY	4000	7830	145	1	4,40	32031/F/BIASY
(E)	G	65	BI-ASY	4000	9440	140	1	4,40	32036/F/BIASY

DALI 2

	colour	W	Optic	K	lm output	lm/W	pcs	Kg	CELL
(E)	G	45	BI-ASY	4000	6750	150	1	4,40	32030/F/BI/DA
(E)	G	54	BI-ASY	4000	7830	145	1	4,40	32031/F/BI/DA
(E)	G	65	BI-ASY	4000	9440	140	1	4,40	32036/F/BI/DA

AUTOTEST (Vedi Pag. 68 - See Page 68)

	colour	W	Optic	K	lm output	lm/W	pcs	Kg	CELL
(E)	G	45	BI-ASY	4000	6750	150	1	4,40	32030/F/BI/EM
(E)	G	54	BI-ASY	4000	7830	145	1	4,40	32031/F/BI/EM
(E)	G	65	BI-ASY	4000	9440	140	1	4,40	32036/F/BI/EM

A richiesta - On demand

Emergency

Con cablaggio in emergenza ad alimentazione centralizzata. Apparecchio permanente, con alimentatore funzionante AC/DC, alimentato da un sistema di emergenza centralizzato, cioè non incorporato nell'apparecchio

With centralized emergency wiring. Permanent device, with AC / DC power supply, powered by a centralized emergency system, i.e. not incorporated into the device

DALI 2 1-10Vdc

È possibile avere LED Felice con ottica Ellittica (E) nella versione **DALI** o **1-10V**;
DALI 2 Aggiungere "D" dopo il codice
1-10V Aggiungere "S" dopo il codice

*It is possible to have Felice LED with Elliptical (E) in the **DALI** or **1-10V** version;*
DALI 2 Add "D" after the code
1-10V Add "S" after the code

LED Felice con LENTE - *with LENS*

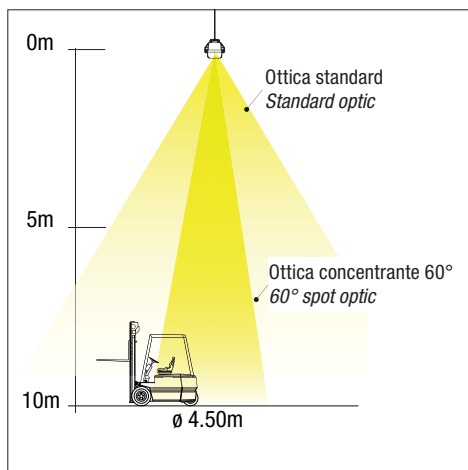
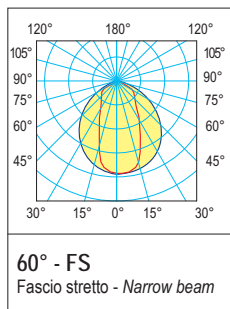

colour	W	Optic	K	lm output	lm/W	pcs	Kg	CELL
G	22	60°	4000	3600	165	1	4,40	32000/FFS
G	36	60°	4000	6000	165	1	4,40	32001/FFS
G	45	60°	4000	7400	165	1	4,40	32030/FFS
G	54	60°	4000	8600	160	1	4,40	32031/FFS
G	65	60°	4000	9750	150	1	4,40	32036/FFS
G	80	60°	4000	11600	145	1	4,40	32034/FFS

AUTOTEST (Vedi Pag. 68 - See Page 68)								
colour	W	Optic	K	lm output	lm/W	pcs	Kg	CELL
G	22 (6)	60°	4000	3600	165	1	4,40	32000/FFSEM
G	36 (6)	60°	4000	6000	165	1	4,40	32001/FFSEM
G	45 (6)	60°	4000	7400	165	1	4,40	32030/FFSEM
G	54 (6)	60°	4000	8600	160	1	4,40	32031/FFSEM
G	65 (6)	60°	4000	9750	150	1	4,40	32036/FFSEM
G	80 (6)	60°	4000	11600	145	1	4,40	32034/FFSEM
G	120 (6)	60°	4000	16800	140	1	4,40	32035/FFSEM

A richiesta: LED Felice con linea passante (aggiungere /S dopo il codice) - Upon request: LED Felice with through-wiring (add /S after the code)

N° massimo di apparecchi collegabili per ogni linea elettrica Maximum number of devices that can be connected to any electrical line	
Potenza W Power W	N° massimo di apparecchi Maximum number of device
24	65
36	40
50	26
54	24
65	20

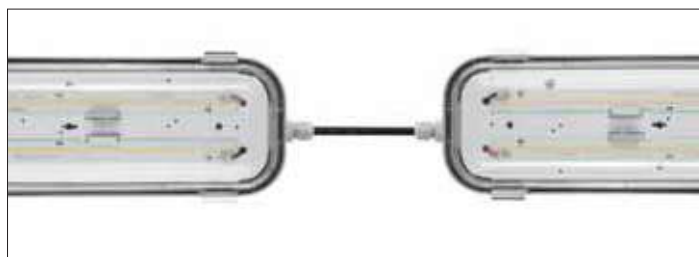

N.B. Corrente di spunto = 25A per 200µs per ogni apparecchio
N.B. Inrush current = 25A for 200µs each

Prezzo: + 10,00 Euro al prezzo lordo standard di listino
Price: + 10,00 Euros to the list price

Accessori inclusi - Included accessories

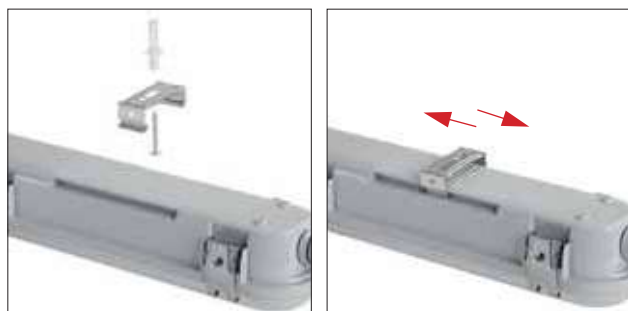

! Staffa di fissaggio a parete/plafone in acciaio inox. Tasselli e viti non compresi. Per l'installazione a parete o soffitto utilizzare tasselli e viti adeguati alla superficie su cui andrà ancorata.

Wall/ceiling fixing bracket made by stainless steel. Plug and screws are not included. For ceiling or wall installation use plug and screws adapted to surface upon which it will be anchored.

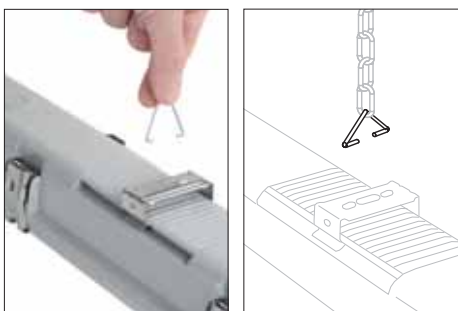

Kit per montaggio a parete/plafone e sospensione
Wall/Ceiling and suspension mounting kit

NON incluso - NOT included

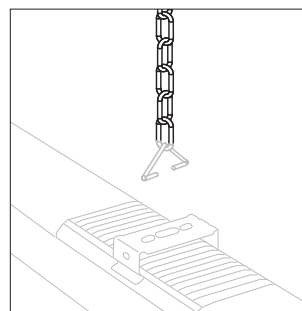

Cod. 000150
Catena 1m per montaggio a sospensione
Suspension assembly chain (1m)

Waterproof luminaires

Luce solo all'occorrenza - Light only when needed

A richiesta - On demand **1-10Vdc** **DALI 2**



Rilevatore di MOVIMENTO a microonde con crepuscolare per impostazione soglia Lux ambiente di intervento, questa tecnologia consente di "nascondere" il rilevatore anche all'interno di corpi lampada infatti esso emette onde elettromagnetiche ad alta frequenza (5,8GHz) e riceve il loro eco, in questo modo è in grado di riconoscere una qualsiasi variazione data da un oggetto non rilevato nella precedente analisi e verrà dato il comando di ON. La trasmissione ad alta frequenza è <10mW e risulta essere 100 volte inferiore alle emissioni di un comune telefono cellulare o di un forno a microonde che emettono mediamente 1000mW.

Microwave MOTION detector with crepuscular. This technology allows the detector to be "hidden" within lamp bodies, in fact it emits electromagnetic waves at a high frequency (5.8GHz) and receives their echoes. In this way, it can recognise any variation given by an object not detected in the previous analysis and the ON command will be given. High frequency transmission is <10mW and is 100 times lower than the emissions of a common mobile phone or a microwave oven emitting an average of 1000mW.

Installazione: da incorporare

Installation: built-in use



Versione **con sensore di rilevamento a distanza Radar Control ON/OFF**. Aggiungere "Y" dopo il codice es. 32000/F-EY. Più Euro 30,00 dal prezzo di listino

Version **with remote detection sensor Radar control ON/OFF**.

Add "Y after the code - ex. 32000/F-EY. + 30,00 Euros from the list price

Sensore Micro onde - Micro Wave sensor

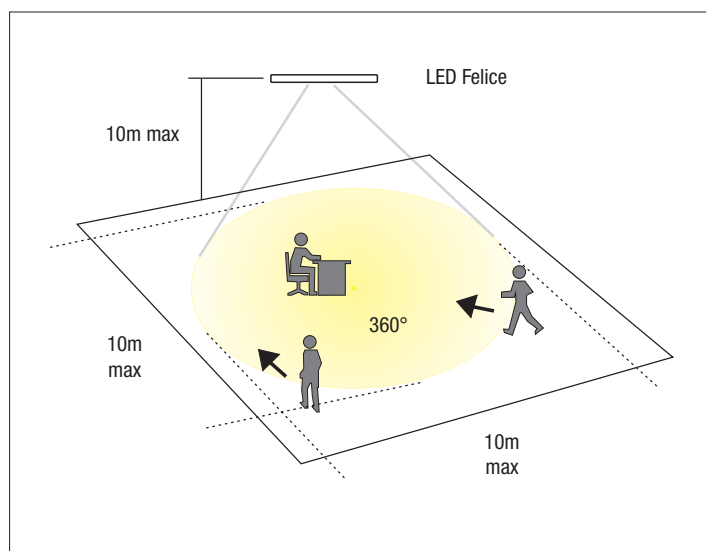

Waterproof luminaires

Dip-switch di settaggio - Setting dip-switch

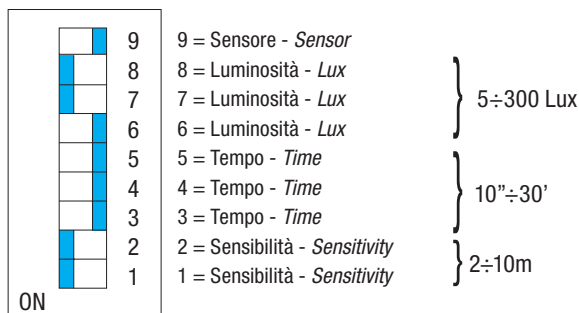

Settaggio di fabbrica - Factory setting

Sensibilità - Sensibility	10 m
Tempo - Time	Ritardato 10s - 10s delayed
Luminosità - Luminosity	200 Lux

Regolazione sensibilità: la sensibilità del sensore viene regolata aumentando o diminuendo il diametro di emissione di onde circolari emesse dal sensore una volta installato ad un'altezza compresa tra 1,5 e 3,5m. Posizionando il micro interruttore nella posizione ON equivale a "1"; posizionandolo nella posizione opposta equivale a "0". Le combinazioni indicate nella tabella 2 permettono di regolare la sensibilità da un minimo di 2 ad un massimo di 10m.

Regolazione tempo: il tempo di accensione può essere impostato da un minimo di 10" ad un massimo di 30'. Ogni movimento rilevato prima dello scadere del tempo impostato resetta automaticamente il tempo stesso, questo per evitare continui cicli di accensione/spengimento. Al fine di ottenere il massimo risparmio energetico si consiglia di impostare il minimo tempo necessario di accensione. Le combinazioni indicate in tabella permettono di regolare il tempo di accensione.

Controllo della luminosità: la scelta della soglia di impostazione della luminosità di accensione può essere impostata come indicato in Tabella 4.

Disabilitazione sensore DIP 9

Set sensitivity: reach is the term used to describe the radii of the more or less circular detection zone produced on the ground after mounting the sensor light at height from 1,5 to 3,5m.

Switch to the ON is "1", switch to the OFF is "0". The combinations indicated in Table 2 allow the sensitivity to be adjusted from a minimum of 2 to a maximum of 10m.

Set time: the ignition time can be set from a minimum of 10" to a maximum of 30'. Each movement detected before the set time expires automatically resets the time itself, this to avoid continuous on/off cycles. In order to achieve maximum energy savings, it is advisable to set the minimum time required for ignition. The combinations indicated in the table allow you to adjust the time of ignition.

Light-control setting: the choice of the switch-o brightness setting threshold can be set as indicated in Table 4.

Sensor disabling DIP 9

Alimentazione - Power supply	220-240Vac
Frequenza - Frequency	50/60Hz
Sistema di alta frequenza - HF system	5,8GHz
Impostazione del tempo - Time setting	10" ÷ 30'
Controllo luminosità - Light control	5÷300 Lux - 24h
Potenza di trasmissione - Transmission power	< 10mW
Angolo di rilevamento - Detection angle	360°
Sensibilità - Sensibility	2÷10m
Potenza - Power	1200W - 600VA
Consumo - Power consumption	± 0,9W

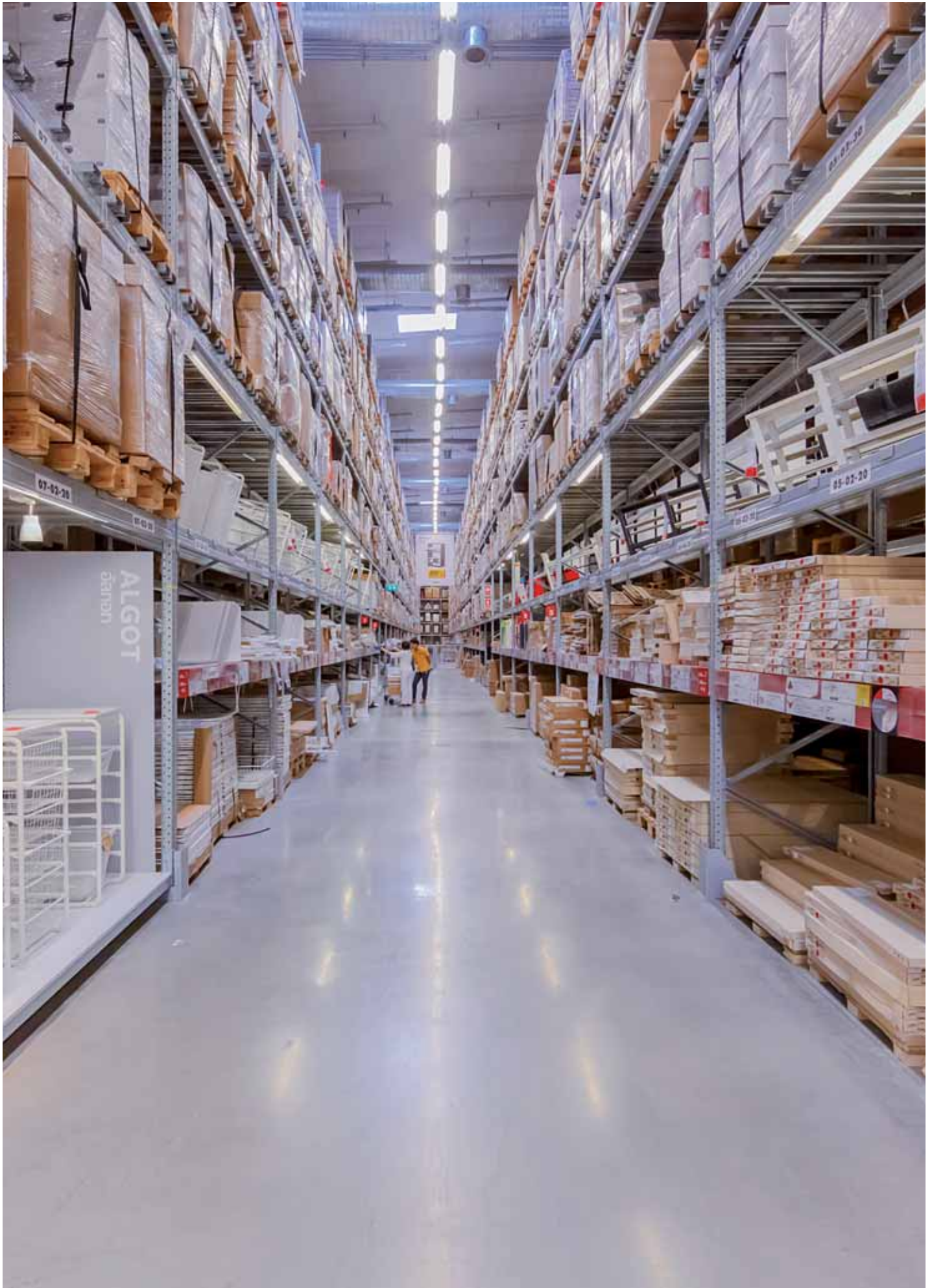

Waterproof luminaires

LED Pupilla sensor DIM

80.000 h

165 Lm/W

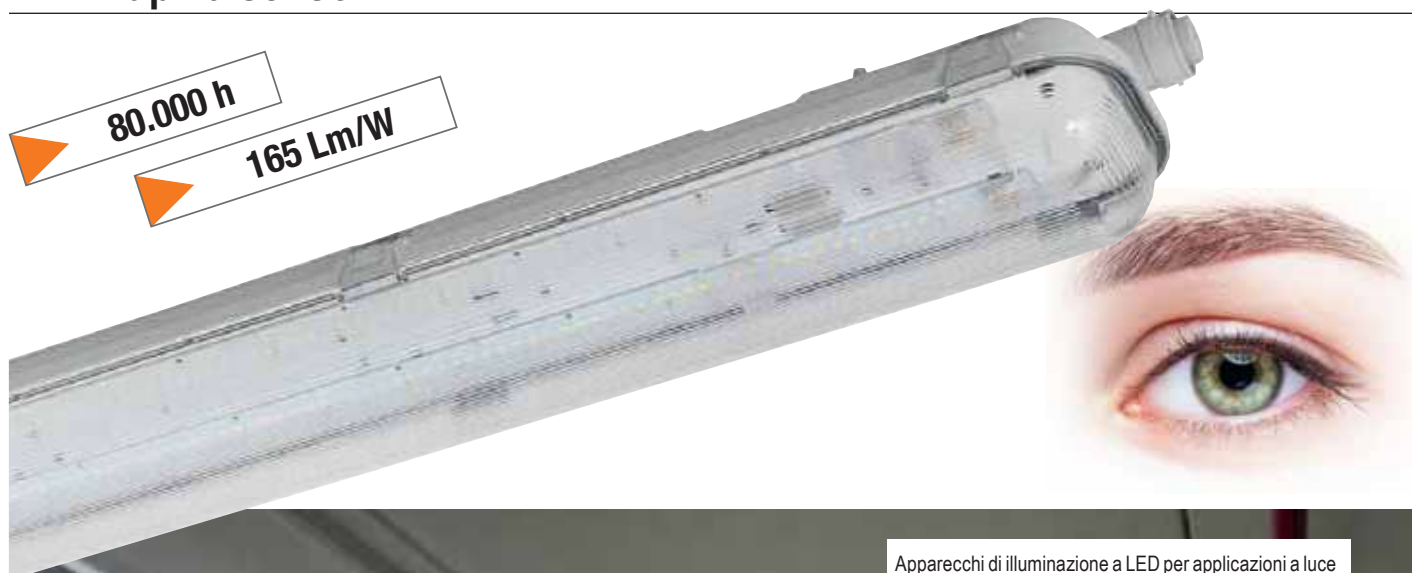

Apparecchi di illuminazione a LED per applicazioni a luce diffusa da interno e da esterno con sensore di presenza/ luminosità integrato nella lampada

Installazione: a soffitto o a sospensione

Corpo: base in plastica rinforzata con vetro **GRP (Glass Reinforced Plastic)**.

Ganci e viteria: in acciaio Inox

Diffusore: in policarbonato trasparente (a richiesta in policarbonato semi opale - aggiungere O dopo il codice). Finitura liscia.

Conforme alla norma: EN62471: 2008, sicurezza fotobiologica delle lampade e sistemi di lampade.

Driver: incluso nel sistema 
Fattore di potenza $\geq 0,90$.

Sorgente: LED **SAMSUNG**

Mantenimento del flusso luminoso minimo al 80% - 80.000h (L80B20).

Temperatura di colore: 4000K. Altre temperature di colore a richiesta (3000K - 5000K - Consegna: 60 giorni).

Norme di riferimento

EN60598-1; EN60598-2-1; EN62471
EN62031; EN60598-2-5; EN61547

LED lighting fixtures for indoor and outdoor diffused light applications with presence / light sensor integrated in the lamp

Housing: in plastic reinforced with GRP glass (Glass Reinforced Plastic).

Installation: ceiling or suspended

Hooks and screws: in stainless steel

Diffuser: made by transparent polycarbonate (in semi-opal polycarbonate on demand - add O after the code). Smooth finish.

Complying to standard: EN62471: 2008, photobiological safety of lamps and lamp systems

*Driver: included included in the system > 50.000 h
Power factor $\geq 0,90$.*

*Source: LED **SAMSUNG***

Maintenance of minimum luminous flux to 80% - 80.000h (L80B20).

Color temperature: 4000K. Other color temperatures on demand (3000K - 5000K - Delivery time: 60 days).

On demand: with microwave motion detector with crepuscular

Standard references

EN60598-1; EN60598-2-1; EN62471
EN62031; EN60598-2-5; EN61547

La certificazione fotometrica dei nostri apparecchi viene sempre effettuata da un istituto esterno. Efficienza luminosa e "lm Output" sono quindi il risultato di tale istituto.

The photometric certification of our appliances is always carried out by an external institute. Luminous efficiency and "lm Output" are therefore the result of this institute.

220-240 Vac	50/60 Hz	IP66	IK09	CRI > 80	+50 C° -20	CE	17 pending			850°	TECEE
RG0	LOW FLICKER	Driver included MULTIPOWER		Driver included RIPPLE FREE							

Luce solo all'occorrenza per un ulteriore risparmio di energia
Light only when needed for further energy saving

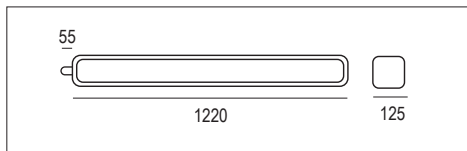
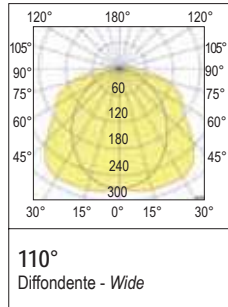

	colour	W	Optic	K	lm output	lm/W	pcs	Kg	CELL
	G	22	110°	4000	3.600	165	1	4,40	32000/F/PUPI
	G	36	110°	4000	6.000	165	1	4,40	32001/F/PUPI
	G	45	110°	4000	7.400	165	1	4,40	32030/FPUPI

A richiesta: LED Pupilla versione EMERGENZA (aggiungere EM dopo il codice)
On demand: LED Pupilla EMERGENCY version (add EM after the code)

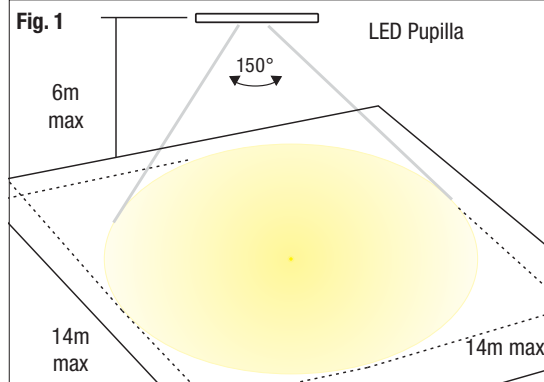
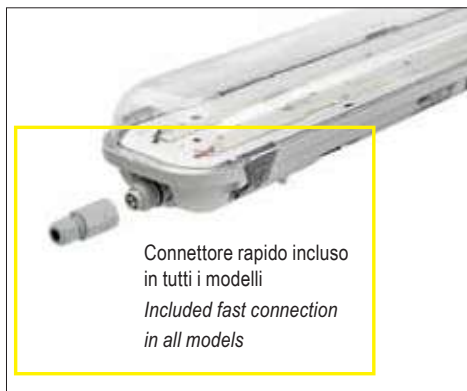

Funzioni del sensore nell'area di rilevamento (Fig. 1):

- A - Rileva un movimento e la luce si accende
- B - Se non rileva alcun movimento, a seconda del livello di luminosità rilevato nell'ambiente la luce dopo un certo tempo verrà regolata secondo la programmazione preimpostata oppure si spegnerà dopo un tempo prestabilito

Sensor functions in the detection area (Fig. 1):

- A - If it detects movement, the light turns on
- B - If it does not detect any movement, depending on the brightness level detected in the environment the light will be adjusted after a certain time according to the preset schedule or it will turn off after a set time

Esempio di funzionamento 2 step di luminosità

Quando non viene rilevato alcun movimento la luce rimane accesa a livello preimpostato (10%, 20%, 30% o 50% di luminosità) <i>When no motion is detected the light stays on at a preset level (10%, 20%, 30% or 50% of brightness)</i>	Quando viene rilevato un movimento il sensore accenderà la luce al 100% di luminosità <i>When motion is detected the sensor will turn on the light to 100% brightness</i>	La luce rimarrà accesa al 100% per il tempo di mantenimento preimpostato (5sec, 30sec, 1min, 5min, 10min, 20min e 30min). <i>The light will stay on at 100% for the preset holding time (5sec, 30sec, 1min, 5min, 10min, 20min and 30min).</i>	Quando non viene rilevato alcun movimento e trascorso il tempo di attesa, il sensore dimmerà la luce al livello di luminosità preimpostato (10%, 20%, 30% o 50% di luminosità) <i>When no motion is detected and the waiting time has elapsed, the sensor dims the light to the preset brightness level (10%, 20%, 30% or 50% of brightness)</i>

Esempio di funzionamento con SPEGNIMENTO RITARDATO

Quando non viene rilevato alcun movimento la luce rimane spenta <i>When no movement the light stayed off</i>	Quando viene rilevato un movimento il sensore accenderà la luce al 100% di luminosità <i>When motion is detected the sensor will turn on the light to 100% brightness</i>	La luce rimarrà accesa al 100% per il tempo di mantenimento preimpostato (5sec, 30sec, 3min, 5min, 10min, 20min e 30min). <i>The light will stay on at 100% for the preset holding time (5sec, 30sec, 3min, 5min, 10min, 20min and 30min).</i>	Quando non viene rilevato alcun movimento e trascorso il tempo di attesa, il sensore dimmerà la luce al livello di luminosità preimpostato (10%, 20%, 30% o 50% di luminosità) <i>When no motion is detected and the waiting time has elapsed, the sensor dims the light to the preset brightness level (10%, 20%, 30% or 50% of brightness)</i>	Dopo 10min il sensore spegnerà la luce <i>After 10min the sensor will turn off the light</i>

LED Allegra ATEX 2-22



Waterproof luminaires

A richiesta - On demand

1-10Vdc

Sensor

DALI 2

Vedi Pag. VI - See page VI

Apparecchio di illuminazione adatto all'ambiente con pericolo di esplosione di gas, polvere e fumi di combustibili. LED Allegra ATEX è conforme ai requisiti richiesti dal decreto governativo 116/2016 Coll. e la Direttiva della Comunità Europea n. 2014/34 / UE

Installazione: a soffitto o a sospensione

Corpo: in policarbonato Grigio (PC) = alta resistenza meccanica

Ganci: acciaio inossidabile + poliammide + 15% fibra di vetro

Diffusore: in policarbonato traslucido (PC) = alta resistenza meccanica

PG: pressacavo in metallo M20x1,5 ATEX PA66 (cavo Ø 6÷12mm²)

Riflettore: lamiera di acciaio. Colore bianco (RAL9003)

Driver: incluso nel sistema > 50.000 h
Fattore di potenza ≥0,95.

Sorgente: LED. Mantenimento del flusso luminoso minimo al 80% - 50.000h (L90B10) per il 90% dei LED.

Temperatura di colore: 4000K

The light fitting is suitable for the environment with a danger of explosion of gas, dust and combustibles fumes. The light fittings meet the requirements of Government Decree 116/2016 Coll. and European Community Directive No.2014/34/EU

Installation: ceiling or suspended

Body: grey polycarbonate (PC) = high mechanical resistance

Hooks and screw: in stainless steel

Clips: stainless steel + polyamide + 15% glass fibre

Diffuser: translucent polycarbonate (PC) = high mechanical resistance

Metal cable glands: screwed M20x1,5 (cavo Ø 6÷12mm²)

Reflector: steel sheet. White colour (RAL9003)

Driver: included included in the system > 50.000 h.
Power factor ≥0,95.

Source: LED. Maintenance of minimum luminous flux to 80% - 50.000h (L90B10) for 90% of LED.

Color temperature: 4000K.

(1) **Statement of Conformity**

(2) Equipment and protective systems intended for use in potentially explosive atmospheres, Directive 2014/34/EU

(3) **Statement of Conformity Number:** TÜV CY 20 ATEX 0206330

(4) for the equipment: LED luminaires
Type: LED ALLEGRA ATEX 2-22 *****/*****

(5) of the manufacturer: Relco S.r.l.

(6) Address: Via delle Azalee, 6/A
20090 Buccinasco - Milano - Italy

Order number: 0206330
Date of issue: 2020-06-12

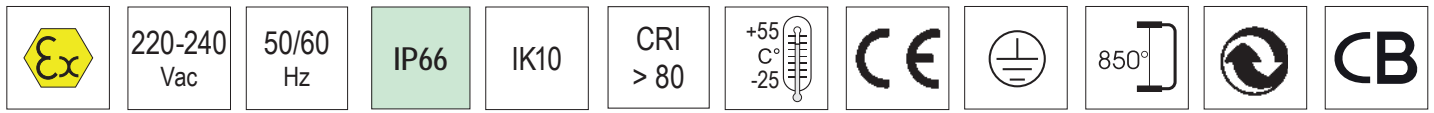

LOW FLICKER

Driver included
MULTIPOWER

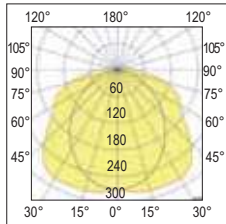
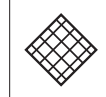

110°
Diffondente - Wide

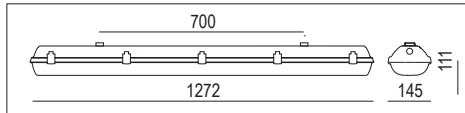

colour	W	Optic	K	lm output	lm/W	pcs	Kg	CELL
G	35 - 42 - 50	110°	4000	Vedi tabella See table	123	1	3,40	32030/AXT



AUTOTEST (Vedi Pag. 68 - See Page 68)								
colour	W	Optic	K	lm output	lm/W	pcs	Kg	CELL-E
G	35	110°	4000	Vedi tabella See table	123	1	3,20	32001/AXTEM
G	42	110°	4000		123	1	3,40	32030/AXTEM
G	50	110°	4000		123	1	3,50	32031/AXTEM

Protezione da atmosfere esplosive <i>Protection against explosive atmospheres</i>	CE Ex II 3G Ex nR IIC T6 Gc
Zona pericolosa ammessa - <i>Hazardous area allowed</i>	Zona 2 - Zone 2 / Zona 22 - Zone 22
Normative di riferimento - <i>Standard references</i>	EN60079-0 / EN60079-15 / EN60079-31

Accessori inclusi - Included accessories



Staffa di fissaggio a parete/plafone in acciaio inox. Tasselli e viti non compresi. Per l'installazione a parete o soffitto utilizzare tasselli e viti adeguati alla superficie su cui andrà ancorata - *Wall/ceiling fixing bracket made by stainless steel. Plug and screws are not included. For ceiling or wall installation use plug and screws adapted to surface upon which it will be anchored.*

Flusso/potenza regolabili manualmente - Flux / power manually adjustable

Per una corretta gestione dell'impianto di illuminazione, bisogna sempre tenere conto sia della necessità di illuminamento realizzato tramite calcolo illuminotecnico, che il rispetto dei consumi energetici. I nostri modelli LED Gioia permettono di ottenere questo risultato poiché sono dotati di Driver multipower; questi particolari Driver consentono di impostare la corrente in uscita tramite dip-switch, fornendo, di conseguenza, la corretta potenza di lampada in base all'esigenza desiderata, permettendo quindi sia il risparmio energetico che il rispetto del flusso luminoso determinato in fase di progetto. *For proper management of the lighting system, it is always necessary to take into account both the need for lighting achieved through lighting engineering calculations, and respect for energy consumption. Our LED Gioia models allow to obtain this result as they are equipped with multipower Driver; these particular drivers allow you to set the output current via dip-switches, thus providing the correct lamp power based on the desired need, thus allowing both energy savings and respect for the luminous flux determined in the design phase.*

LED Driver multipotenza incluso <i>LED Driver multipower included</i>		
I mA	W	Lm output
350	35	4.300
420	42	5.200
500	50	6.150
Taratura di fabbrica <i>Factory setting</i>		



Dip switch per la selezione della corrente in uscita
Equipped with dip switch for selection the output current



Possibilità di collegamento passante in fila continua (accessori inclusi).
Possibility of through connection in continuous line (accessories included).



Morsetteria 5 poli per ripartizione su linea trifase.
5-pole terminal block for distribution on three-phase line.

Waterproof luminaires

LED Allegra Metal



Apparecchio stagno di illuminazione a LED per applicazioni a luce diffusa da interno e da esterno.
Adatto all'illuminazione di stabilimenti di produzione, magazzini, depositi.

Installazione: a soffitto o a sospensione

Corpo: corpo in acciaio stampato in un unico pezzo di elevata resistenza meccanica

Ganci: in acciaio inossidabile AISI 304

Diffusore: in policarbonato opale autoestinguente V2 stabilizzato ai raggi UV.

Driver: multipotenza incluso > 50.000 h

Fattore di potenza ≥ 0.95.

Sorgente: LED **LG** Mantenimento del flusso luminoso minimo al 80% - 50.000h (L80B10) per il 90% dei LED.

Norme di riferimento

EN60598-1; EN60598-2-1; EN62471; EN61547

Classificazione rischio fotobiologico: gruppo esente

A richiesta: 3000K o 6000K con sovrapprezzo di 30,00 Euro
Direttiva HACCP per gli impianti illuminotecnici nelle industrie alimentari

LED waterproof luminaire for diffused indoor and outdoor light applications.

Suitable for lighting production facilities, warehouses, warehouses, pavilions, workshop areas and large areas in general.

Installation: ceiling or suspended

Body: body in pressed steel in a single piece of high mechanical resistance

Clips: in AISI 304 stainless-steel

Diffuser: in self-extinguishing opal polycarbonate V2 UV stabilised

Driver: multipower cluded > 50.000 h

Power factor ≥ 0.95.

*Source: LED **LG** Maintenance of minimum luminous flux to 80% - 50.000h (L80B10) for 90% of LED.*

Standard references

EN60598-1; EN60598-2-1; EN62471; EN61547

Photobiological risk classification: no risk

*Upon request: 3000K or 6000K with a 30.00 Euro extra charge
HACCP directive for lighting systems in food industries*

La certificazione fotometrica dei nostri apparecchi viene sempre effettuata da un istituto esterno. Efficienza luminosa e "lm Output" sono quindi il risultato di tale istituto.

The photometric certification of our appliances is always carried out by an external institute. Luminous efficiency and "lm Output" are therefore the result of this institute.

A richiesta - On demand



Consegna 30 gg - Delivery 30 days
Vedi Pag. VI - See page VI

Waterproof luminaires

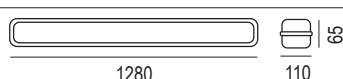

A richiesta: lunghezza 650mm o 1560mm.
Consegna 90 giorni.
*On request: length 650mm or 1560mm
Delivery 90 days.*

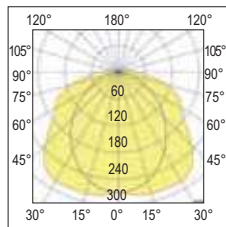

110°
Diffondente - Wide

CRI
> 80



220-240 Vac	50/60 Hz	IP65	IK06	IK09	A richiesta On demand
		85°			
RG1	Driver included MULTIPOWER	Driver included RIPPLE FREE			

LED Driver multipotenza incluso LED Driver multipower included				
PIN 1	PIN 2	I mA	W	Lumen output
OFF	OFF	900	48*	5.800
OFF	ON	1.050	56	7.200
ON	OFF	1.100	60	7.730
ON	ON	1.200	65	8.500
Settaggio di fabbrica - Factory setting				



Dip switch per la selezione della corrente in uscita
Equipped with dip switch for selection the output current

	colour	W	Optic	K	lm output	lm/W	pcs	Kg	CELL
	A	45* - 56 - 65	120°	4000	See Table	130	1	6,60	32031/60/MET
1-10Vdc	A	45* - 56 - 65	120°	4000	See Table	130	1	6,60	32031/60/M010
DALI 2	A	45* - 56 - 65	120°	4000	See Table	130	1	6,60	32031/60/MDAL
	A	45* - 56 - 65	120°	4000	See Table		1	6,60	CELL-E 32031METEM
	A	45* - 56 - 65	120°	4000	See Table		1	6,60	CELL-E 3203160M010EM
	A	45* - 56 - 65	120°	4000	See Table		1	6,60	CELL-E 3203160MDALEM

LED Allegra Metal

Accessori NON inclusi - *NOT included accessories*



Cod. 000151
Kit 2 ganci sicurezza anticaduta - *Kit of 2 safety hooks against fall*

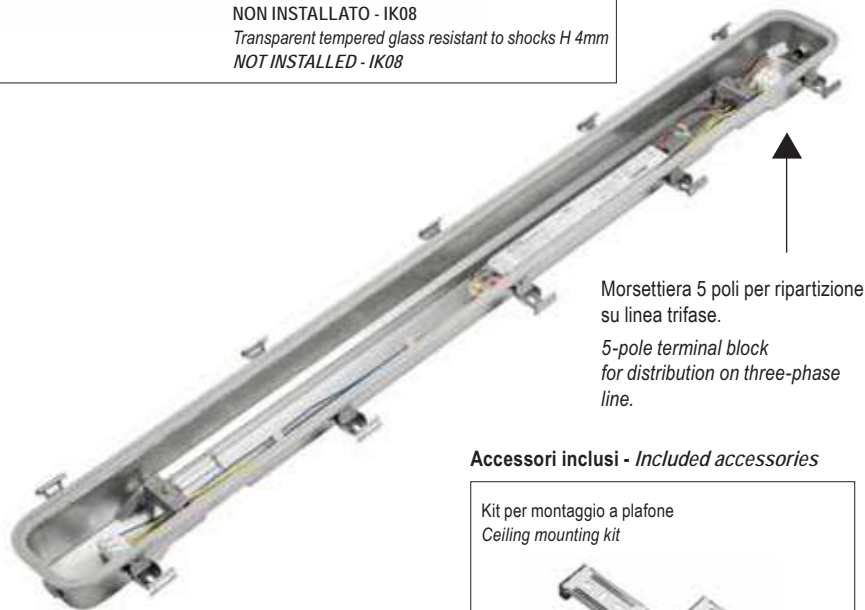

Accessori inclusi - *Included accessories*

Kit per montaggio a plafone
Ceiling mounting kit



N° massimo di apparecchi collegabili per ogni linea elettrica
Maximum number of devices that can be connected to any electrical line

W Puissance - Leistung	N° maximum d'appareils Max. Anzahl der Geräte
45	26
56	30
65	20

A richiesta - *On demand*



Emergency

Con cablaggio in emergenza ad alimentazione centralizzata. Apparecchio permanente, con alimentatore funzionante AC/DC, alimentato da un sistema di emergenza centralizzato, cioè non incorporato nell'apparecchio

With centralized emergency wiring. Permanent device, with AC / DC power supply, powered by a centralized emergency system, i.e. not incorporated into the device



Waterproof luminaires

LED Lanterna NEW

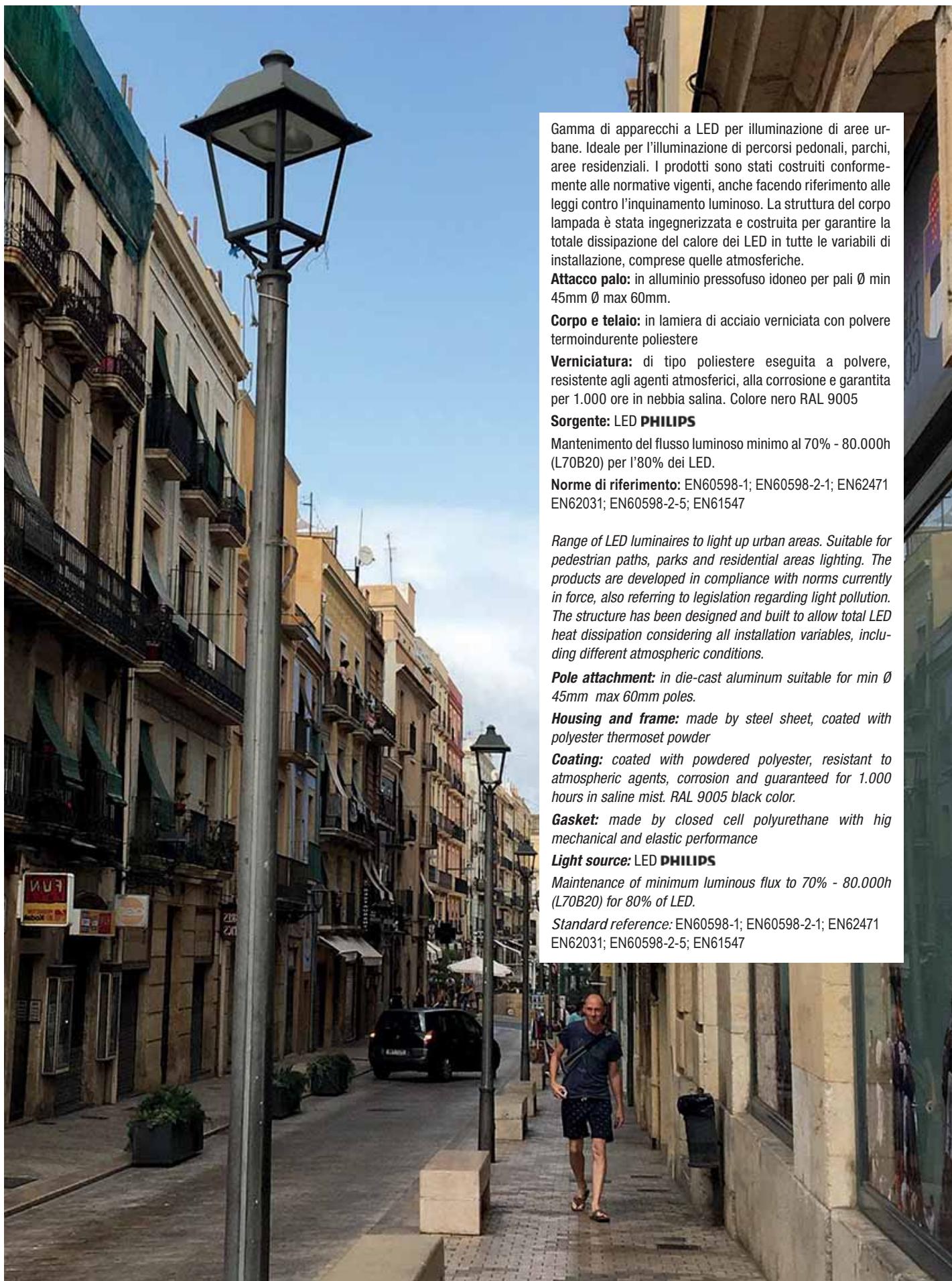

Gamma di apparecchi a LED per illuminazione di aree urbane. Ideale per l'illuminazione di percorsi pedonali, parchi, aree residenziali. I prodotti sono stati costruiti conformemente alle normative vigenti, anche facendo riferimento alle leggi contro l'inquinamento luminoso. La struttura del corpo lampada è stata ingegnerizzata e costruita per garantire la totale dissipazione del calore dei LED in tutte le variabili di installazione, comprese quelle atmosferiche.

Attacco palo: in alluminio pressofuso idoneo per pali Ø min 45mm Ø max 60mm.

Corpo e telaio: in lamiera di acciaio verniciata con polvere termoindurente poliestere

Verniciatura: di tipo poliestere eseguita a polvere, resistente agli agenti atmosferici, alla corrosione e garantita per 1.000 ore in nebbia salina. Colore nero RAL 9005

Sorgente: LED **PHILIPS**

Mantenimento del flusso luminoso minimo al 70% - 80.000h (L70B20) per l'80% dei LED.

Norme di riferimento: EN60598-1; EN60598-2-1; EN62471 EN62031; EN60598-2-5; EN61547

Range of LED luminaires to light up urban areas. Suitable for pedestrian paths, parks and residential areas lighting. The products are developed in compliance with norms currently in force, also referring to legislation regarding light pollution. The structure has been designed and built to allow total LED heat dissipation considering all installation variables, including different atmospheric conditions.

Pole attachment: in die-cast aluminum suitable for min Ø 45mm max 60mm poles.

Housing and frame: made by steel sheet, coated with polyester thermoset powder

Coating: coated with powdered polyester, resistant to atmospheric agents, corrosion and guaranteed for 1.000 hours in saline mist. RAL 9005 black color.

Gasket: made by closed cell polyurethane with high mechanical and elastic performance

Light source: LED **PHILIPS**

Maintenance of minimum luminous flux to 70% - 80.000h (L70B20) for 80% of LED.

Standard reference: EN60598-1; EN60598-2-1; EN62471 EN62031; EN60598-2-5; EN61547

100-240
Vac

50/60
Hz

IP66

IK08

CRI
> 70

+40
C°
-20



850°

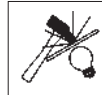

Driver included



RG0



LOW
FLICKER

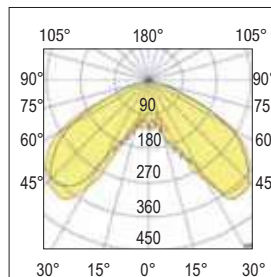
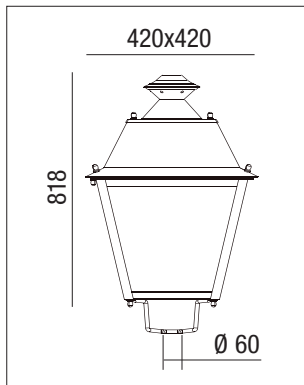

Ottica STANDARD per illuminazione parchi - STANDARD optics recommended for lighting in parks LT-20485

colour	W	Optic	K	lm output	lm/W	pcs	Kg	CELL
N	24	ST	2200	2.760	115	1	8,20	LANT2422K
N	24	ST	3000	2.760	115	1	8,20	LANT243K
N	24	ST	4000	2.760	115	1	8,20	LANT244K
N	56	ST	2200	2.760	115	1	8,20	LANT5622K
N	56	ST	3000	6.440	115	1	8,20	LANT563K
N	56	ST	4000	6.440	115	1	8,20	LANT564K
N	75	ST	2200	6.440	115	1	8,20	LANT7522K
N	75	ST	3000	8.630	115	1	8,20	LANT753K
N	75	ST	4000	8.630	115	1	8,20	LANT754K



Street furniture

Esempi applicativi con accessori non inclusi - Application example with not included accessories



Cod. LANT-SOSP-SUP
Staffa superiore per applicazione a parete
Upper bracket for wall application



Cod. LANT-SOSP-INF
Staffa inferiore per applicazione a parete
Lower bracket for wall application



Cod. VETTRASPPOL
Diffusore in vetro
Glass diffuser



Cod. VETTRASFORO
Con foro per Lanterna
con alimentazione
dal basso
*With hole for Lanterna
with power supply
from below*



Cod. VETTRASNOFORO
Senza foro per Lanterna
con alimentazione
dall'alto
*Without hole for Lanterna
with power supply
from above*

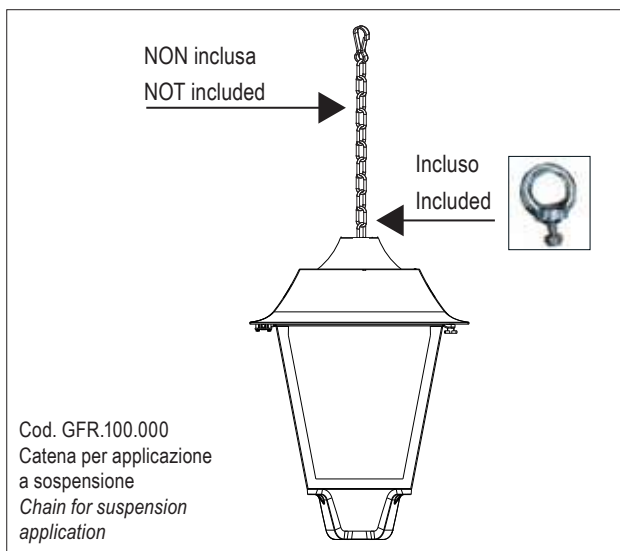

Cod. GFR.100.000
Catena per applicazione
a sospensione
*Chain for suspension
application*

Street furniture



LED Lanterna NEW

UPGRADE LED per LANTERNE
UPGRADE LED for LANTERNE



100-240
Vac

50/60
Hz



IP66

IK10



CRI
>70

La soluzione di relamping LED permette:

- Riduzione dei costi di intervento e manutenzione.
- Facilità di installazione senza modifiche strutturali

The LED relamping solution allows:

- Cost reduction of intervention and maintenance.
- Easy installation without structural modifications



VECCHIO - OLD



NUOVO - NEW



260x190x75mm



275x200x80mm



Materiale: alluminio di elevata purezza

Diffusore: vetro trasparente

Finitura: silver

Potenza: 20÷80W - 100 Lm/W

Ottiche: 4 modelli in PMMA

Temperatura di colore: bianco caldo o bianco neutro

LED: CREE 3535

Mantenimento del flusso luminoso minimo al 70% - 80.000h (L70B20) per l'80% dei LE

Peso: 1,10 Kg

Prezzo: On demand

Structure material: high purity aluminium

Diffuser material: transparent glass

Structure finish: silver

Power: 20÷80W - 100 Lm/W

Optical: 4 models PMMA

Color temperature: warm white or neutral white

LED: CREE 3535

Maintenance of minimum luminous flux to 70% - 80.000h (L70B20) for 80% of LED.

Net weight: 1,10 Kg

Price: On demand

LED Lampione 2 - 4 - 6 - 8 - 10 - 12

Gamma di apparecchi a LED per illuminazione di aree urbane. Ideale per l'illuminazione di percorsi pedonali, parchi, aree residenziali. I prodotti sono stati costruiti conformemente alle normative vigenti, anche facendo riferimento alle leggi contro l'inquinamento luminoso.

Attacco palo: in alluminio pressofuso idoneo per pali Ø min 45mm Ø max 60mm.

Corpo e bracci: in alluminio pressofuso UNI 5076 verniciato con polvere termoidurente poliestere garantita per 1.500 ore in nebbia salina.

Ottiche: in PMMA con resistenza alle alte temperature e ai raggi UV.

Verniciatura: di tipo poliestere eseguita a polvere, resistente agli agenti atmosferici, alla corrosione e garantita per 1.500 ore in nebbia salina.

- Colore Nero RAL 9005

(LED Lampione 2 / 4)

- Grigio RAL 9007 (a richiesta RAL 9005)

(LED Lampione 6 / 8 / 10 / 12).

Schermo: vetro temperato di spessore 4mm resistente agli shock termici (Lampione 2). In policarbonato spessore 2,5mm resistente agli shock termici e agli urti (Lampione 4, 6 e 8)

Sorgente: LED **SAMSUNG**

Mantenimento del flusso luminoso minimo al 70% - 80.000h (L70B20) per l'80% dei LED.

Temperatura di colore: 2200K, 3000K e 4000K. CRI >70

Driver: incorporato . Fattore di potenza ≥0,98.

A richiesta: Il settaggio del flusso luminoso può essere modificato tramite programmazione della corrente di pilotaggio da richiedere in sede in fase d'ordine.

Protezione alle sovratensioni secondo le normative vigenti.

A richiesta modo differenziale 6kV (L-N)

modo comune 8kV (L-GND, N-GND, L&N-GND)

Norme di riferimento:

IEC 61000-4-5; EN60598-1; EN60598-2-1; EN62471; EN62031; EN60598-2-5;

EN61547

Range of LED luminaires for urban lighting. Ideal for lighting pedestrian walkways, parks, residential areas. The products have been built in accordance with current regulations, also referring to the laws against light pollution.

Pole attachment: in die-cast aluminum suitable for min Ø 45mm max 60mm poles.

Body and arms: in die-cast aluminum UNI 5076 painted with thermosetting polyester powder guaranteed for 1,500 hours in saline mist.

Optics: in PMMA with resistance to high temperatures and UV rays.

Painting: polyester powder type, resistant to atmospheric agents, corrosion and guaranteed for 1,500 hours in saline mist.

- Black color RAL 9005

(LED Lampione 2 / 4)

- Grey RAL 9007 (on demand RAL 9005)

(LED Lampione 6 / 8 / 10 / 12)

Screen: 4mm thick tempered glass resistant to thermal shock (Lamp post 2). In polycarbonate 2,5 mm thick, resistant to thermal shocks and impacts (Lamp post 4, 6 and 8)

Source: LED **SAMSUNG**

Maintenance of the minimum luminous flux of 70% - 80,000h (L70B20) for 80% of the LEDs.

Color temperature: 2200K, 3000K and 4000K. CRI >70

Driver: built-in. Power factor ≥0.98.

On request: The setting of the luminous flux can be changed by programming the driving current to be requested when ordering.

Overvoltage protection according to current regulations.

On request 6kV differential mode (L-N)

common mode 8kV (L-GND, N-GND, L & N-GND)

Reference standards:

IEC 61000-4-5; EN60598-1; EN60598-2-1; EN62471; EN62031; EN60598-2-5;

EN61547

LED Lampione 2 - 4 - 6 - 8 -10 - 12



A richiesta - On demand

1-10Vdc

DALI 2

DYNA

Wireless

Vedi Pag. VI - See page VI

DYNA control - Mezzanotte virtuale - Virtual midnight

Settaggio del flusso luminoso: avviene tramite programmazione della corrente di pilotaggio da richiedere in sede in fase d'ordine / progetto
Luminous flux setting: takes place by programming the driving current to be requested at the time of the order / project

DYNA CONTROL è un sistema automatico di controllo del flusso luminoso delle lampade. Il sistema entra in funzione alla prima accensione calcolando per 3 giorni i tempi di accensione, il quarto giorno il sistema in modo autonomo, calcola la mezzanotte virtuale eseguendo una regolazione del flusso regolando la lampada come indicato sullo schema di Fig. 1; per i primi tre giorni, quindi, il sistema manterrà le lampade accese al 100%, nel tempo di accensione dell'impianto, il quarto giorno entrerà in funzione il sistema DYNA CONTROL gestendo in modo autonomo il flusso luminoso garantendo così un notevole risparmio energetico.

Accensioni inferiori ad 1 ora (es. manutenzione) verranno ignorate ed il sistema non entra in funzione, per accensioni da 1 a 4 ore (es. anomalia impianto) o superiori alle 23 ore (es. impianto sempre acceso), il sistema resetta il timer quindi ricomincerà a contare per i primi 3 giorni e successivamente riprenderà il funzionamento automatico.

DYNA CONTROL is an automatic control system for the luminous flux of the lamps. The system comes into operation at the first start-up by calculating the ignition times for 3 days, on the fourth day the system autonomously calculates the virtual midnight by adjusting the flow by adjusting the lamp as indicated in the diagram in Fig. 1; for the first three days, therefore, the system will keep the lamps on at 100%, during the system start-up time, on the fourth day the DYNA CONTROL system will come into operation, independently managing the luminous flux thus ensuring significant energy savings.

Switch-ons of less than 1 hour (e.g. maintenance) will be ignored and the system does not start up, for switch-ons from 1 to 4 hours (e.g. system anomaly) or longer than 23 hours (e.g. system always on), the system resets the timer will then start counting again for the first 3 days and will then resume automatic operation.

Fig. 1

Esempio applicativo 2 steps - Application example 2 steps

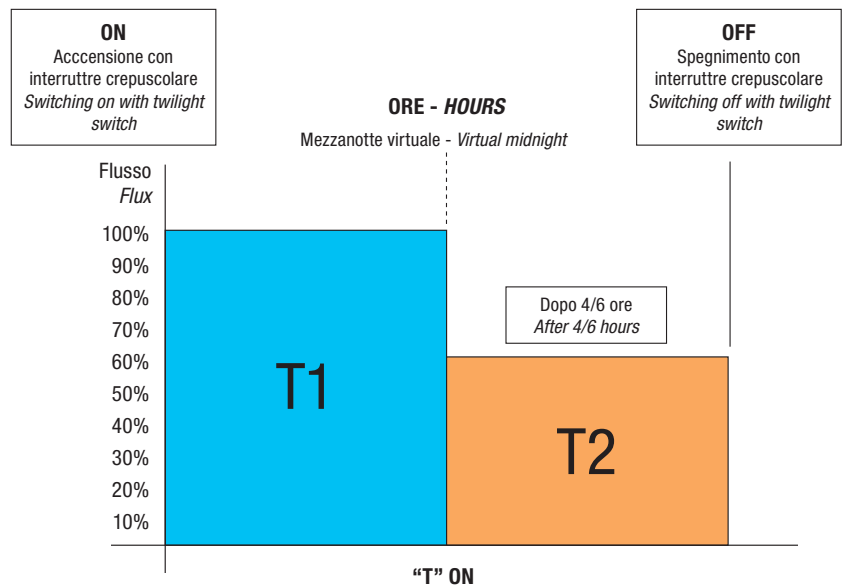

T1 = 100% Flusso luminoso - Luminous flux

T2 = 70% Flusso luminoso - Luminous flux

Minimo tempo di accensione per funzionamento automatico 4 ore (3 giorni).

Accensioni di 1 ora ignorate.

Accensioni da 1 a 4 ore oppure superiori alle 23 ore resettano il sistema.

The minimum ignition time for automatic operation is 4 hours (three days).

Ignitions 1 hour ignored.

Switching from 1 to 4 hours or higher with 23 hours reset the system.

LED Lampione 2 - 4



LED Lampione 2



LED Lampione 4

**Apparecchio predisposto
all'installazione su palo di
metallo. La RELCO NON
FORNISCE I PALI**

LED Lampione 2



A richiesta: 2200K
On demand: 2200K

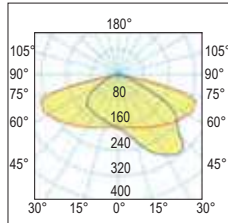

ST/CDL
Stradale - Street optic
LT-20320 5050

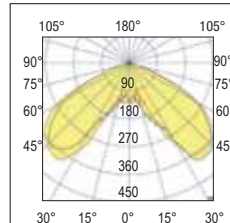

Optica consigliata per illuminazione parchi - Optics recommended for lighting in parks
LT-20485

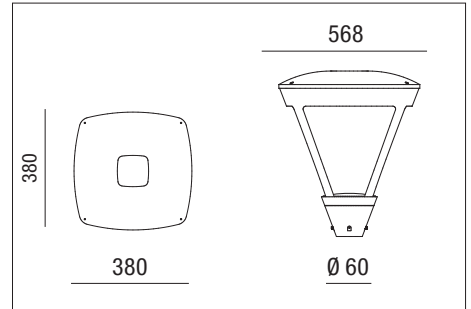

220-240 Vac 110 Vac a richiesta on demand

50/60 Hz IP66 IK08

+50°C -20°C 0,37 m² 850°

CRI >70

DRIVER INCLUDED



RG0

LOW FLICKER

colour	W	Optic	K	lm output	lm/W	pcs	Kg	CELL
N	24	ST	3000	3.000	135	1	9,00	31510/3KS
N	24	ST	4000	3.000	135	1	9,00	31510S
N	56	ST	3000	7.280	130	1	9,00	31512/3KS
N	56	ST	4000	7.280	130	1	9,00	31512S
N	75	ST	3000	9.300	125	1	9,00	31513/3KS
N	75	ST	4000	9.300	125	1	9,00	31513S

LED Lampione 4

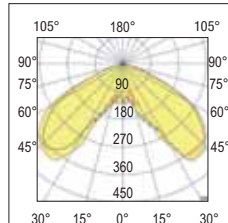

Optica STANDARD per illuminazione parchi - STANDARD optics recommended for lighting in parks
LT-20485

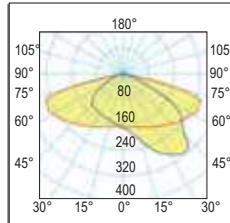

ST/CDL
Optica stradale a richiesta
On demand Street optic
LT2032050508L

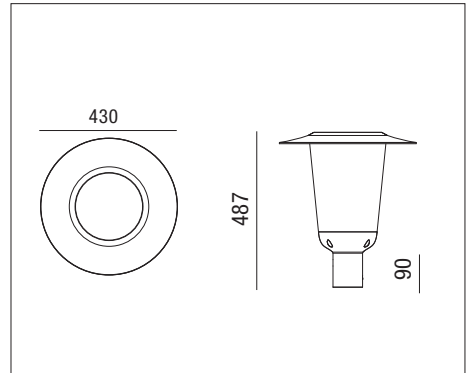

220-240 Vac 110 Vac a richiesta on demand

50/60 Hz IP66 IK08

+50°C -20°C 0,37 m² 850°

CRI >70

DRIVER INCLUDED



RG0

LOW FLICKER

colour	W	Optic	K	lm output	lm/W	pcs	Kg	CELL
N	24	PK	3000	3.360	140	1	9,00	32510/3KS
N	24	PK	4000	3.360	140	1	9,00	32510S
N	56	PK	3000	7.840	140	1	9,00	32512/3KS
N	56	PK	4000	7.840	140	1	9,00	32512S
N	75	PK	3000	10.500	140	1	9,00	32513/3KS
N	75	PK	4000	10.500	140	1	9,00	32513S

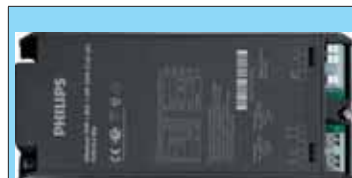

Tutti gli apparecchi di illuminazione di questo catalogo utilizzano un Driver LED "MULTIPOWER". A richiesta, per quantità, è possibile cambiare in fabbrica la taratura della corrente e, di conseguenza potenza (W) e Lumen (Lm)

All the luminaires in this catalog use a "MULTIPOWER" LED Driver.
On request, for quantity, it is possible to change the current calibration in the factory and, consequently, power (W) and Lumen (Lm)



LED Lampione 6

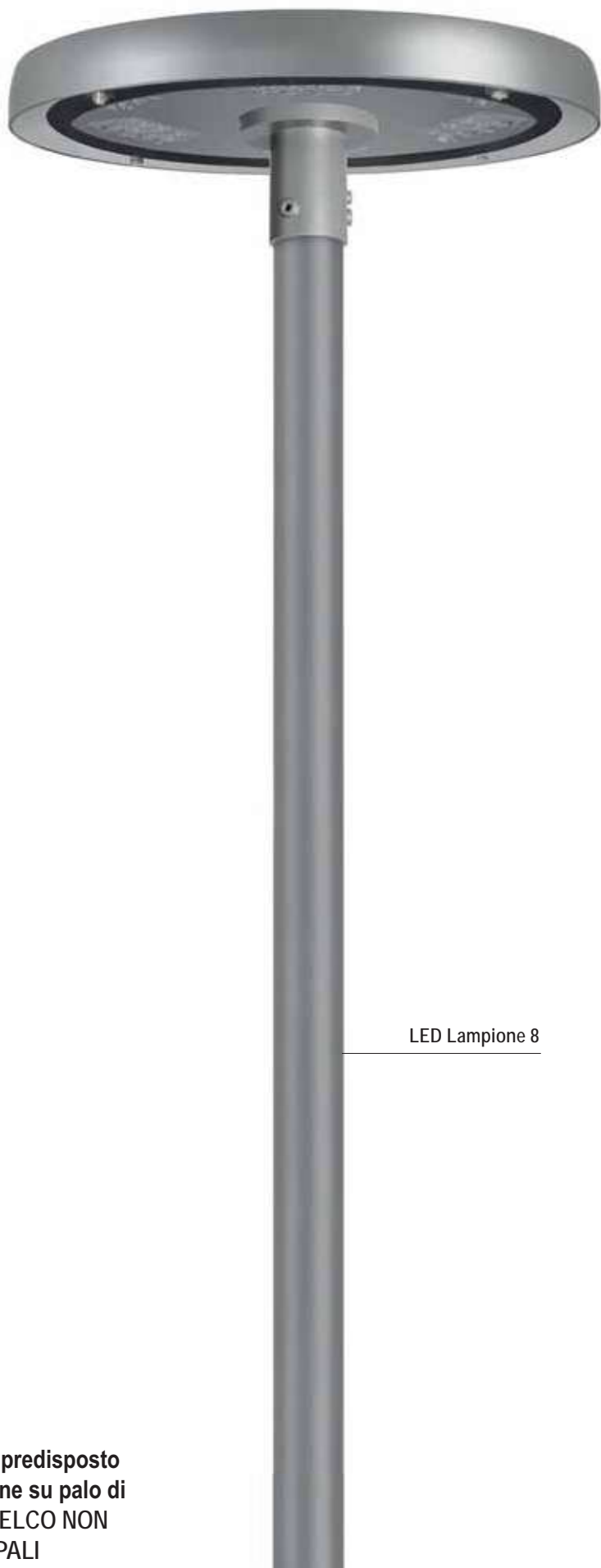

LED Lampione 8

Apparecchio predisposto
all'installazione su palo di
metallo. La RELCO NON
FORNISCE I PALI

LED Lampione 6

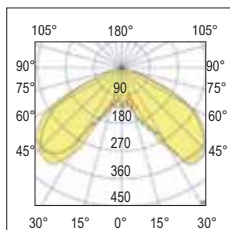

Optica STANDARD per illuminazione parchi - STANDARD optics recommended for lighting in parks LT-20485

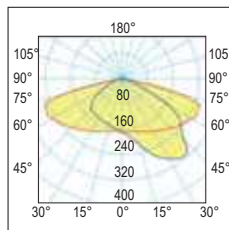

ST/CDL
Optica stradale a richiesta
On demand Street optic LT-20320 5050

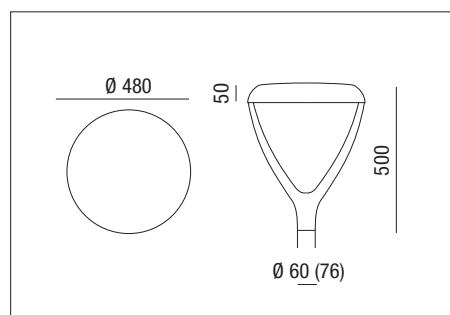

220-240 Vac

110 Vac a richiesta on demand

50/60 Hz

IP66

IK08

+50 C°
-20

0,37 m²

850°

CRI >70



DRIVER INCLUDED



RG0

LOW FLICKER

colour	W	Optic	K	lm output	lm/W	pcs	Kg	CELL
N	24	PK	3000	3.000	135	1	9,00	LAMP6ST243K
N	24	PK	4000	3.000	135	1	9,00	LAMP6ST244K
N	56	PK	3000	7.280	130	1	9,00	LAMP6ST563K
N	56	PK	4000	7.280	130	1	9,00	LAMP6ST564K
N	75	PK	2200	9.300	125	1	9,00	LAMP6ST752K
N	75	PK	3000	9.300	125	1	9,00	LAMP6ST753K
N	75	PK	4000	9.300	125	1	9,00	LAMP6ST754K

LED Lampione 8

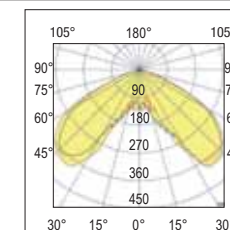

Optica STANDARD per illuminazione parchi - STANDARD optics recommended for lighting in parks LT-20485

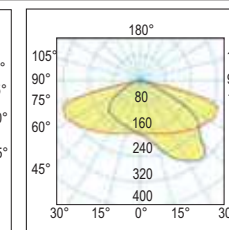

ST/CDL
Optica stradale a richiesta
On demand Street optic LT-20320 5050

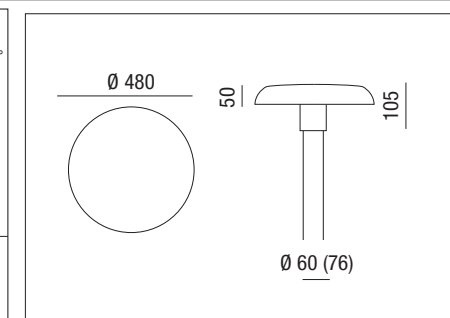

220-240 Vac

110 Vac a richiesta on demand

50/60 Hz

IP66

IK08

+50 C°
-20

0,37 m²

850°

CRI >70



DRIVER INCLUDED



RG0

LOW FLICKER

colour	W	Optic	K	lm output	lm/W	pcs	Kg	CELL
N	24	PK	3000	3.000	135	1	9,00	LAMP8ST243K
N	24	PK	4000	3.000	135	1	9,00	LAMP8ST244K
N	56	PK	3000	7.280	130	1	9,00	LAMP8ST563K
N	56	PK	4000	7.280	130	1	9,00	LAMP8ST564K
N	75	PK	2200	9.300	125	1	9,00	LAMP8ST752K
N	75	PK	3000	9.300	125	1	9,00	LAMP8ST753K
N	75	PK	4000	9.300	125	1	9,00	LAMP8ST754K



LED Lampione 10



LED Lampione 12



Apparecchio predisposto
all'installazione su palo di
metallo. La RELCO NON
FORNISCE I PALI

LED Lampione 10

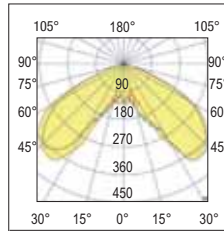

Ottica STANDARD per illuminazione parchi - STANDARD optics recommended for lighting in parks LT-20485

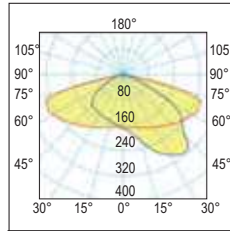

ST/CDL Ottica stradale a richiesta On demand Street optic LT-20320 5050

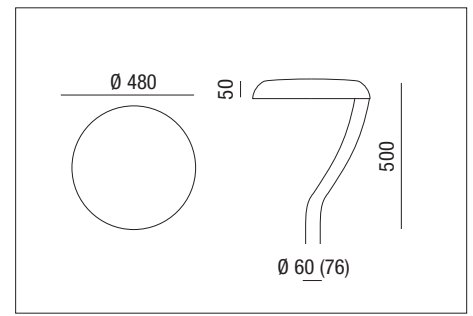

220-240 Vac	110 Vac a richiesta on demand	50/60 Hz	IP66	IK08	+50°C / -20°C	0,37 m ²	850°	CRI >70	CE
-------------	-------------------------------	----------	------	------	---------------	---------------------	------	---------	----

DRIVER INCLUDED RGO LOW FLICKER

colour	W	Optic	K	lm output	lm/W	pcs	Kg	CELL
N	24	PK	3000	3.000	135	1	9,00	LAMP10ST243K
N	24	PK	4000	3.000	135	1	9,00	LAMP10ST244K
N	56	PK	3000	7.280	130	1	9,00	LAMP10ST563K
N	56	PK	4000	7.280	130	1	9,00	LAMP10ST564K
N	75	PK	2200	9.300	125	1	9,00	LAMP10ST752K
N	75	PK	3000	9.300	125	1	9,00	LAMP10ST753K
N	75	PK	4000	9.300	125	1	9,00	LAMP10ST754K

LED Lampione 12

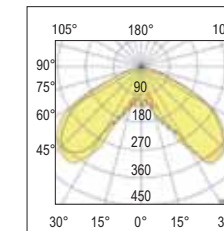

Ottica STANDARD per illuminazione parchi - STANDARD optics recommended for lighting in parks LT-20485

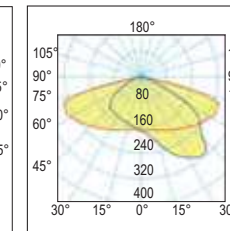

ST/CDL Ottica stradale a richiesta On demand Street optic LT-20320 5050

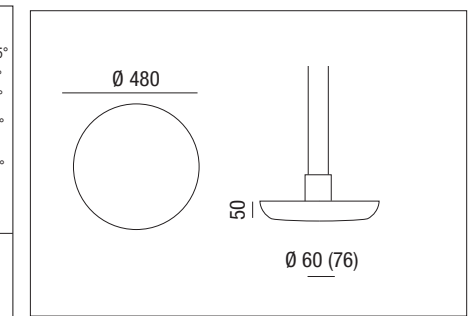

220-240 Vac	110 Vac a richiesta on demand	50/60 Hz	IP66	IK08	+50°C / -20°C	0,37 m ²	850°	CRI >70	CE
-------------	-------------------------------	----------	------	------	---------------	---------------------	------	---------	----

DRIVER INCLUDED RGO LOW FLICKER

colour	W	Optic	K	lm output	lm/W	pcs	Kg	CELL
N	24	PK	3000	3.000	135	1	9,00	LAMP12ST243K
N	24	PK	4000	3.000	135	1	9,00	LAMP12ST244K
N	56	PK	3000	7.280	130	1	9,00	LAMP12ST563K
N	56	PK	4000	7.280	130	1	9,00	LAMP12ST564K
N	75	PK	2200	9.300	125	1	9,00	LAMP12ST752K
N	75	PK	3000	9.300	125	1	9,00	LAMP12ST753K
N	75	PK	4000	9.300	125	1	9,00	LAMP12ST754K

Predisposizione Zhaga Socket
Zhaga Socket preparation

A richiesta - On demand
Sistema wireless per gestire centralmente l'illuminazione pubblica.
Wireless system to centrally manage public lighting.

Accessori non inclusi Not included accessories

Code: 210001465
Adattatore palo da Ø 60mm a Ø 76mm.
Necessario per l'installazione su palo
Up Ø 60mm to 76mm adapter pole. Required for installation on the pole

Street furniture

Gamma di apparecchi a LED per illuminazione di aree urbane. Ideale per l'illuminazione di strade, vicoli, parcheggi, aree residenziali. I prodotti sono stati costruiti conformemente alle normative vigenti, anche facendo riferimento alle leggi contro l'inquinamento luminoso.

Attacco palo: in alluminio pressofuso idoneo per pali Ø min 45mm Ø max 60mm.

Corpo: in alluminio pressofuso UNI EN 1706 verniciato con polvere termoindurente poliestere garantita per 1.500 ore in nebbia salina.

Colore: Grigio RAL 9007 (a richiesta Nero RAL 9005)

Ottica: stradale diffondente (altre ottiche a richiesta)

Guarnizione: in poliuretano a celle chiuse dalle rilevanti prestazioni meccaniche ed elastiche

Sorgente: LED **SAMSUNG**

Mantenimento del flusso luminoso minimo al 90% - 100.000h (L90B10) per il 90% dei LED.

Temperatura di colore: 3000K / 4000K (altre temperature di colore a richiesta);

Cablaggio: con cavo di alimentazione lunghezza 30cm

Power factor: ≥0,95

A richiesta protezione alle sovratensioni:

modo differenziale 6kV (L-N)

modo comune 8kV (L-GND, N-GND, L&N-GND)

Norme di riferimento: IEC 61000-4-5; EN60598-1; EN60598-2-1; EN62471; EN62031; EN60598-2-5; EN61547

Range of LED luminaires to light up urban areas. Suitable for streets, narrow roads, car parks and residential areas lighting. The products are developed in compliance with norms currently in force, also referring to legislation regarding light pollution.

Pole attachment: in die-cast aluminum suitable for min Ø 45mm max 60mm poles.

Body: made by UNI EN 1706 die-cast aluminum, coated with polyester thermoset powder guaranteed for 1,500 hours in saline mist

Colour: RAL 9007 Grey color (on demand RAL 9005 Black color)

Optic: street diffused (other optics on request)

Gasket: made by closed cell polyurethane with high mechanical and elastic performance

Light source: LED **SAMSUNG**

Maintenance of minimum luminous flux to 90% - 100.000h (L90B10) for 90% of LED.

Color temperature: 3000K; **Wiring:** with supply cable, length 30cm

Power factor: ≥0,95

On demand surge protection:

differential mode 6kV (L-N)

standard mode 8kV (L-GND, N-GND, L&N-GND).

Standard reference: IEC 61000-4-5; EN60598-1; EN60598-2-1; EN62471; EN62031; EN60598-2-5; EN61547

A richiesta - On demand

1-10Vdc

DALI 2

DYNA

Wireless

Sensor)))

Vedi Pag. VI - See page VI

100-240 Vac	50/60 Hz	IP66	IK09	CRI > 70	+40 C -20		CE	850°			
Driver included 		RGO		LOW FLICKER							



Apparecchio predisposto all'installazione su palo di metallo. La RELCO NON FORNISCE I PALI



colour	W	Optic	K	nominal lm tc = 25°C	lm output	lm/W	pcs	Kg	CELL
G	20	ST	4000	3.000	2.600	130	1	5,00	31525
G	30	ST	4000	4.500	3.900	130	1	5,00	31530
G	40	ST	4000	6.000	5.200	130	1	5,00	31540
G	50	ST	4000	7.800	6.500	130	1	5,00	31545
G	60	ST	4000	9.000	7.800	130	1	5,00	31560
G	75	ST	4000	11.200	9.750	130	1	5,00	31575
G	75	ST	4000	11.200	9.750	130	1	5,00	31575-DA
G	50	ST	3000	7.800	6.500	130	1	5,00	31545-3K
G	75	ST	3000	11.200	9.750	130	1	5,00	31575-3K

DALI 2

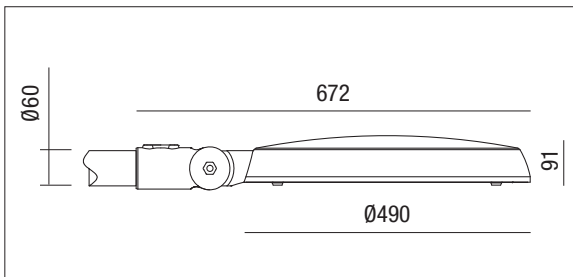

Zhaga Socket
Accessorio a richiesta
On demand accessory



Sistema di comunicazione Wireless
Possibilità di complementazione di diverse tecnologie
Programmazione e controllo da remoto mediante gateway in loco
Monitoraggio in tempo reale dello stato del sistema e raccolta dati idoneità al relamping per il risparmio energetico
Ideale per applicazioni commerciali, industriali ed ambienti esterni

Accessori non inclusi
Not included accessories



Code: 10001465
Adattatore palo da Ø 60mm a Ø 76mm.
Necessario per l'installazione su palo
Up Ø 60mm to 76mm adapter pole.
Required for installation on the pole

Ottica di serie
Standard optic

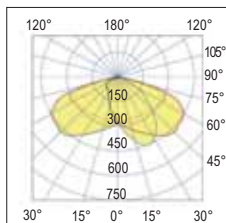

ST/CDL
Stradale - Street optic

Ottiche a richiesta
Optics on demand

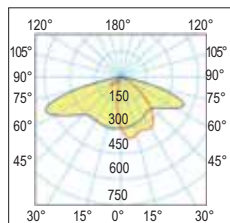

ST/CDL1
Ottica stradale consigliata per strade con pista ciclabile
Road optics recommended for roads with cycle tracks

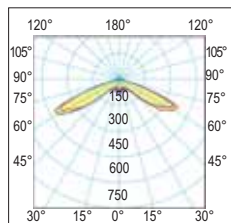

ST/CDL2
Ottica consigliata per illuminazione parchi
Optics recommended for lighting in parks

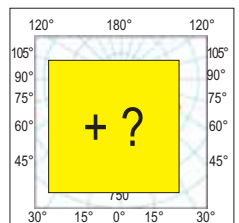

A richiesta è possibile fornire l'apparecchio con ottiche diverse da quelle già proposte
On request, it is possible to supply the device with optics other than those already proposed

LED Minisempione - LED Sempione - LED Maxisempione - LED Megasempione



Street furniture

La certificazione fotometrica dei nostri apparecchi viene sempre effettuata da un istituto esterno. Efficienza luminosa e "lm Output" sono quindi il risultato di tale istituto.

The photometric certification of our appliances is always carried out by an external institute. Luminous efficiency and "lm Output" are therefore the result of this institute.

A richiesta - On demand

1-10Vdc



DYNA

Wireless

Vedi Pag. VI - See page VI

Gamma di apparecchi a LED per illuminazione di aree urbane. Ideale per l'illuminazione di strade, parcheggi, aree residenziali.

Installazione: attacco palo in alluminio pressofuso idoneo per pali di diametro min. 55mm - max. 65mm, orientabile da ± 0 a $\pm 20^\circ$ o a "frusta".

Corpo e telaio: in alluminio pressofuso UNI EN 1706 verniciato con polvere termoindurente poliestere.

Imbocco a palo: in alluminio pressofuso UNI EN 1706, verniciato con polvere termoindurente poliestere, con goniometro graduato per un corretto puntamento del fascio luminoso.

Verniciatura: di tipo poliestere eseguita a polvere, resistente agli agenti atmosferici e alla corrosione e garantita per 1.200 ore in nebbia salina (ISO 9227). Colore Grigio RAL 9007 (a richiesta RAL 1013).

Schermo: vetro temperato di spessore 4mm resistente agli shock termici e agli urti.

Ottica: In PMMA con resistenza alle alte temperature, agli shock termici e agli urti.

Sorgente: LED **SAMSUNG**

Mantenimento del flusso luminoso minimo al 90% - 100.000h (L90B10) per il 90% dei LED.

Temperatura di colore: 4000K; altre temperature di colore a richiesta (2200K - 2700K - 3000K - 5000K - Consegna 60 giorni).

Protezione alle sovratensioni inclusa:

Modo differenziale 6kV (L-N)

Modo comune 8kV (L-GND, N-GND, L&N-GND)

A richiesta: versione con protezione maggiorata (10kV) contro gli impulsi aggiungendo il cod. RO0640/N.

Driver: incorporato

Fattore di potenza $\geq 0,98$.

Norme di riferimento: IEC 61000-4-5; EN60598-1; EN60598-2-1; EN62471; EN62031; EN60598-2-3; EN61547

Range of LED luminaires to light up urban areas. Suitable for roads, car parks and residential areas lighting.

Installation: mast top mounting in die cast aluminium suitable for poles with a diameter of min. 55mm - max. 65mm, that can be pivoted ± 0 to $\pm 20^\circ$ or side mounting

Housing and frame: made by UNI EN 1706 die-cast aluminium, coated with polyester thermoset powder.

Pole entrance: made by UNI EN 1706 die-cast aluminium, coated with polyester thermoset powder, with graduated goniometer to allow the correct orientation of light beam.

Coating: coated with powdered polyester, resistant to atmospheric agents, corrosion and guaranteed for 1.200 hours in saline mist (ISO 9227).

Grey RAL 9007 color (on demand RAL 1013).

Shield: tempered glass with 4mm thickness resistant to thermal shocks and collisions.

Optic: PMMA optic with high temperature resistance, thermal shock and impact resistance

Light source: LED **SAMSUNG**

Maintenance of minimum luminous flux to 90% - 100.000h (L90B10) for 90% of LED.

Color temperature: 4000K; other color temperatures available on demand (2200K - 2700K - 3000K - 5000K. Delivery time: 60 days)

Protection against overvoltages included:

Differential mode 6kV (L-N)

Standard mode 8kV (L - GND, N-GND, L&N-GND).

On demand: this version with greater protection (10kV) with code RO0640/N.

Driver: included

Power factor $\geq 0,98$

Standard reference: IEC 61000-4-5; EN60598-1; EN60598-2-1; EN62471; EN62031; EN60598-2-3; EN61547

LED Minisempione - LED Sempione - LED Maxisempione - LED Megasempione

Durata e Aspettativa di vita del LED

Contrariamente alle lampade tradizionali, il LED non si spegne improvvisamente all'esaurimento della sua vita utile, ma diminuisce, in tempi molto lunghi, il flusso iniziale fino al suo completo esaurimento. Il LED non si rompe (se non per difettosità), ma subisce un decadimento continuo dell'efficienza. La durata di vita indica la percentuale di decadimento del flusso luminoso (L) riferita ad un numero di ore utili di funzionamento. L'aspettativa di Vita (B) indica la percentuale di componenti che, raggiunte le ore utili di funzionamento, non mantengono le caratteristiche di flusso luminoso dichiarate. Per esempio un LED dichiarato L80/B10=100.000 ore, indica che al raggiungimento delle 100.000 ore il 90% (B10) dei moduli LED fornisce ancora l'80% del flusso luminoso iniziale (L80)

LED service life expectancy

Unlike traditional lamps, they do not tend to go out suddenly at the end of their useful life, but slowly decrease in flux until they expire. The LED does not break (unless it is defective), but declines gradually in performance. The drop in LED flux, defined as the useful life, is represented by the acronym L80 (see graph), which means flux at 80%. Value "B" followed by a value between 10 and 50 indicates the quality of the component being used, defining the percentage of LED that does not maintain the declared characteristics when the 100,000 hours have elapsed.

LED: mantenimento del flusso luminoso - TM21 (compreso fine del ciclo di vita) LED: maintenance of the lighting flux - TM21 (including end of life cycle)						
	n° LED	W	L80B10 @ta: +25°C	L80B10 @ta: +45°C	L90B10 @ta: +25°C	L90B10 @ta: +45°C
LED Minisempione	128	50	> 100.000 h	> 100.000 h	70.000 h	50.000 h
	128	75				
LED Sempione	192	95	> 100.000 h	> 100.000 h	70.000 h	50.000 h
	192	120				
LED Maxisempione	320	160	> 100.000 h	> 100.000 h	70.000 h	50.000 h
	80	210				
LED Megasempione	144	250	> 100.000 h	> 100.000 h	70.000 h	50.000 h
	144	300				

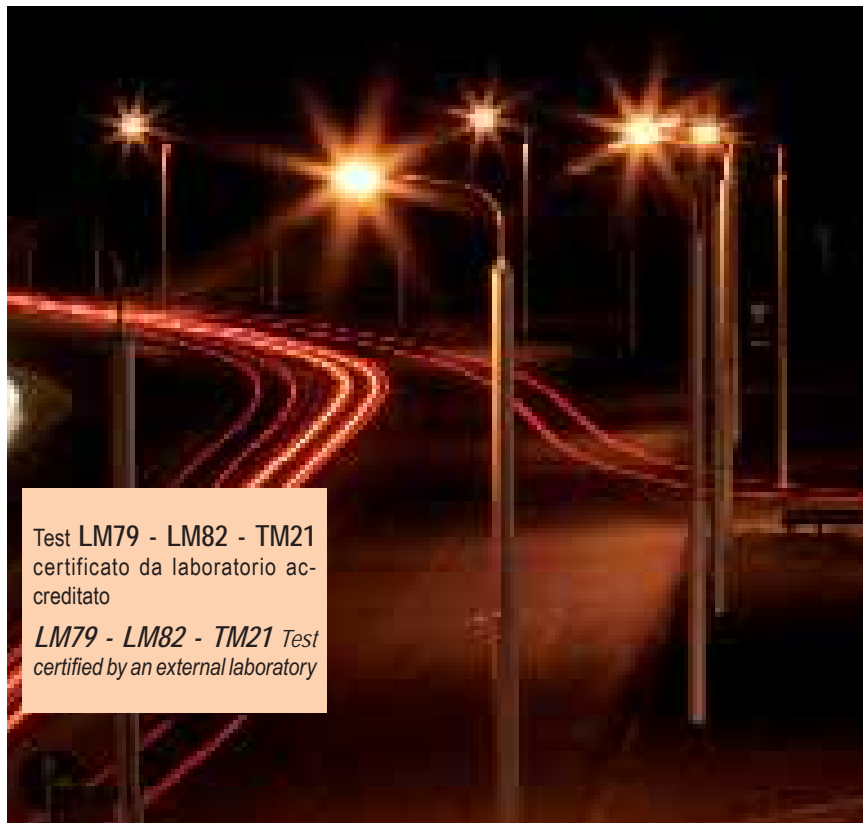
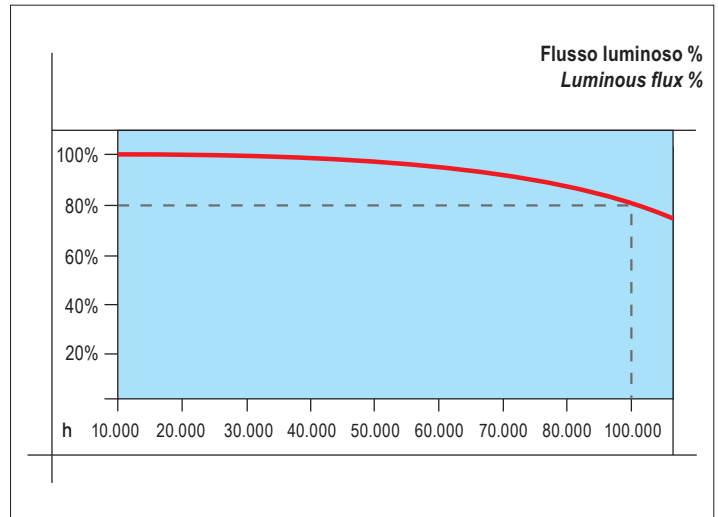

Test LM79 - LM82 - TM21
certificato da laboratorio accreditato

LM79 - LM82 - TM21 Test
certified by an external laboratory



ST/CDL

ST1,1 - l = 12h / d = 1,1
Intensity class: G*3

ST0,9 - l = 15h / d = 0,9 / h <= 16
Intensity class: G*3

ST1,3 - l = 10h / d = 1,3
Intensity class: G*3

Classi di intensità CEN (classificazione provvisoria) e valore stimato del relativo ULOR massimo - CEN intensity classes (provisional classification) and estimated value of its maximum ULOR

Class	70truept o	80truept o	90truept o	95truept o	
Prelim.					
G1		200 cd/klm	50 cd/klm		~ 31%
G2		150 cd/klm	30 cd/klm		~ 18,8%
G3		100 cd/klm	20 cd/klm		~ 12,6%
G4	500 cd/klm	100 cd/klm	10 cd/klm	0 cd/klm	~ 0,55%
G5	350 cd/klm	100 cd/klm	10 cd/klm	0 cd/klm	~ 0,55%
G6	350 cd/klm	100 cd/klm	0 cd/klm	0 cd/klm	0%

Street furniture



I modelli della serie LED Sempione sono conformi alle prove di vibrazione, secondo la Norma EN 60598-1 certificata da Ente esterno: Illuminazione stradale - Vibrazione degli apparecchi di illuminazione

The models of the LED Sempione series comply with vibration tests, according to the EN 60598-1 standard certified by the external body: Street lighting - Vibration of lighting fixtures

220-240 Vac	110 Vac On demand	50/60 Hz	IP66	IK09	CRI > 70	+45°C -30°C	CE	17	N		
850°			TECEE	LOW FLICKER	RG0	DRIVER INCLUDED MULTIPOWER RIPPLE FREE	RoHS compliance				

LED Minisempione

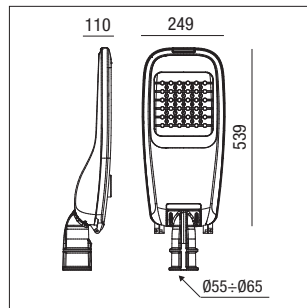

colour	W	Optic	K	nominal lm tc = 25°C	lm output	lm/W	pcs	Kg	CELL
G	20	ST	4000	3.450	3.000	150	1	5,00	36000/20S
G	30	ST	4000	5.200	4.500	150	1	5,00	36000/30S
G	40	ST	4000	6.900	6.000	150	1	5,00	36000/40S
G	50	ST	4000	8.250	7.500	150	1	5,00	36000S
1-10Vdc	G	60	ST	10.350	9.000	150	1	5,00	36001/60S
1-10Vdc	G	75	ST	12.400	11.250	150	1	5,00	36001S
DALI 2	G	75	ST	12.400	11.250	150	1	5,00	36001DA
1-10Vdc	G	50	ST	3000	7.840	7.250	145	5,00	36000/3KS
Zhaga	G	75	ST	3000	11.780	10.900	145	5,00	36001/3KS
Zhaga	G	20	ST	4000	3.450	3.000	150	5,00	36000/20ZH
Zhaga	G	30	ST	4000	5.200	4.500	150	5,00	36000/30ZH
Zhaga	G	40	ST	4000	6.900	6.000	150	5,00	36000/40ZH
Zhaga	G	50	ST	4000	8.250	7.500	150	5,00	36000SZH
Zhaga	G	60	ST	4000	10.350	9.000	150	5,00	36001/60ZH
Zhaga	G	75	ST	4000	12.400	11.250	150	5,00	36001ZH
DYNA	G	20	ST	4000	3.450	3.000	150	5,00	36000/20DY
DYNA	G	30	ST	4000	5.200	4.500	150	5,00	36000/30DY
DYNA	G	40	ST	4000	6.900	6.000	150	5,00	36000/40DY
DYNA	G	50	ST	4000	8.250	7.500	150	5,00	36000SDY
DYNA	G	60	ST	4000	10.350	9.000	150	5,00	36001/60DY
DYNA	G	75	ST	4000	12.400	11.250	150	5,00	36001DY

LED Sempione

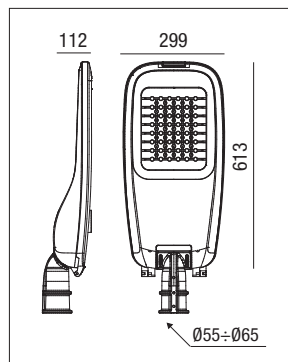

colour	W	Optic	K	nominal lm tc = 25°C	lm output	lm/W	pcs	Kg	CELL
1-10Vdc	G	95	ST	4000	15.650	14.250	150	6,00	36100S
	G	120	ST	4000	18.500	16.800	140	6,00	36200
1-10Vdc	G	95	ST	3000	14.870	13.800	145	6,00	36100/3KS
	G	120	ST	3000	17.800	16.200	135	6,00	36200/3K

Ottica di serie Standard optic

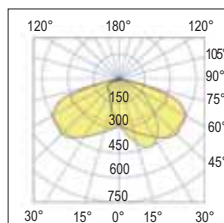

ST/CDL
Stradale - Street optic

Ottiche a richiesta Optics on demand

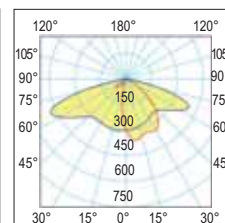

ST/CDL1
Ottica stradale consigliata per strade con pista ciclabile
Road optics recommended for roads with cycle tracks

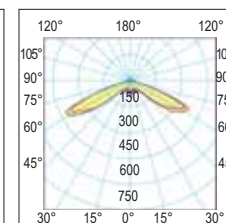

ST/CDL2
Ottica consigliata per illuminazione parchi
Optics recommended for lighting in parks

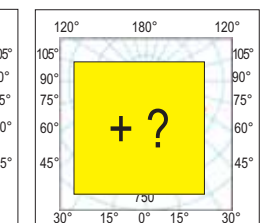

A richiesta è possibile fornire l'apparecchio con ottiche diverse da quelle già proposte
On request, it is possible to supply the device with optics other than those already proposed

Street furniture

LED Maxisempione

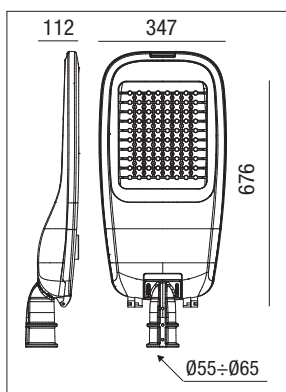

colour	W	Optic	K	nominal lm tc = 25°C	lm output	lm/W	pcs	Kg	CELL
G	150	ST	4000	22.400	19.500	130	1	7,00	36145
1-10Vdc	G	160	ST	4000	24.850	22.400	140	7,00	36250S
1-10Vdc	G	210	ST	4000	28.900	26.250	125	7,00	36251
1-10Vdc	G	160	ST	3000	24.850	22.400	140	7,00	36250/3KS
1-10Vdc	G	210	ST	3000	28.900	26.250	125	7,00	36251/3K



LED Megasempione

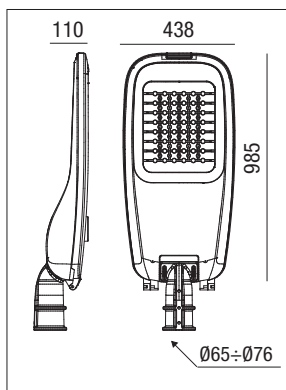

colour	W	Optic	K	nominal lm tc = 25°C	lm output	lm/W	pcs	Kg	CELL
G	250	ST	4000	39.000	30.500	122	1	15,30	36601
1-10Vdc	G	300	ST	4000	47.250	36.850	119	15,50	36600
DALI 2	G	300	ST	4000	47.250	36.850	119	15,50	36600DA
1-10Vdc	G	250	ST	3000	39.000	30.500	122	15,30	36601/3K
1-10Vdc	G	300	ST	3000	47.250	36.850	119	15,50	36600/3K

Optica di serie Standard optic

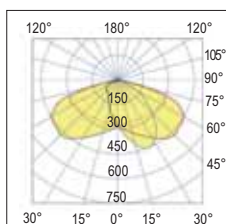

ST/CDL
Stradale - Street optic

Ottiche a richiesta Optics on demand

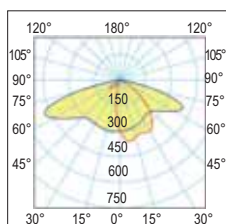

ST/CDL1
Optica stradale consigliata
per strade con pista
ciclabile
Road optics recommended
for roads with cycle tracks

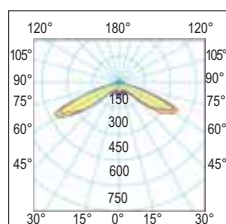

ST/CDL2
Optica consigliata per
illuminazione parchi
Optics recommended for
lighting in parks

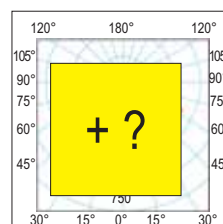

A richiesta è possibile fornire
l'apparecchio con ottiche
diverse da quelle già proposte
On request, it is possible to
supply the device with optics
other than those already
proposed

LED Minisempione - LED Sempione - LED Maxisempione - LED Megasempione

Dettagli Details



Completo di dispositivo anticondensa.
Pressacavo con valvola di compensazione e riciclo dell'aria
Complete with anti-condensate device.
Cable gland with valve for compensation and circulation of air.



Completo di sezionatore di linea in doppio isolamento che interrompe l'alimentazione elettrica all'apertura del body.
Complete with line disconnector in double insulation that interrupts the power supply when the body is opened.



Nel LED Driver è incluso il dispositivo di controllo della temperatura all'interno dell'apparecchio con ripristino automatico.

Protezione contro gli impulsi 8kV conforme alla Norma EN 61547.

The LED driver includes the temperature control device inside the device with automatic reset.

8kV Impulse protection in accordance with EN 61547.



Completo di connettore IP68 per una rapida installazione

Complete with IP68 connector for quick installation

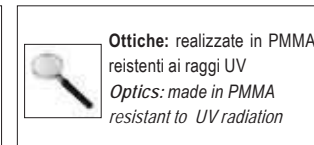

Accessori non inclusi - Not included accessories



Per un'ulteriore protezione.
Dispositivo conforme alla Norma EN 61547 contro i fenomeni impulsivi atto a proteggere il modulo LED e il relativo alimentatore: classe II (a richiesta protezione fino a 10kV)
Protection device in compliance with the EN 61547 standard to counteract the impulsive phenomena designed to protect the LED module and the relative power supply: class II (protection up to 10kV available on request)

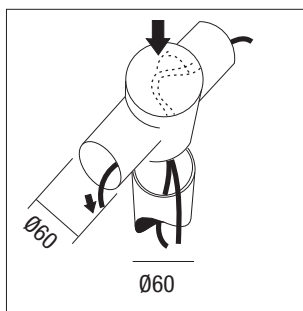

Gestione del punto luce per un ulteriore risparmio di energia (richiedere preventivo) - Management of the lighting point for further energy savings (Request a quotation)

Regolazione 1÷10V 1÷10V control	Mezzanotte virtuale Virtual midnight	Zhaga Socket	Telegestione sistema Wi-Fi (da concordare) Wi-Fi system remote management (to be agreed)
Possibilità di regolazione 10% - 100% con sistema 1÷10V Possibility of adjustment 10% - 100% with 1-10V system	Sistema con riduzione automatica del flusso System with automatic flux reduction	Predisposizione sul corpo dell'apparecchio. Ideale per la gestione dell'illuminazione autonoma locale tramite sensori o da remoto. For installation on the body of the appliance. Ideal for autonomous management of the lighting, either locally with sensors or remotely	Sistema di controllo, gestione consumi e diagnosi dell'impianto con tecnologia Wi-Fi Control system, consumption management and diagnosis of the system with Wi-Fi technology

DYNA control - Mezzanotte virtuale - Virtual midnight

Settaggio del flusso luminoso: avviene tramite programmazione della corrente di pilotaggio da richiedere in sede in fase d'ordine / progetto
Luminous flux setting: takes place by programming the driving current to be requested at the time of the order / project

DYNA CONTROL è un sistema automatico di controllo del flusso luminoso delle lampade. Il sistema entra in funzione alla prima accensione calcolando per 3 giorni i tempi di accensione, il quarto giorno il sistema in modo autonomo, calcola la mezzanotte virtuale eseguendo una regolazione del flusso regolando la lampada come indicato sullo schema di Fig. 1; per i primi tre giorni, quindi, il sistema manterrà le lampade accese al 100%, nel tempo di accensione dell'impianto, il quarto giorno entrerà in funzione il sistema DYNA CONTROL gestendo in modo autonomo il flusso luminoso garantendo così un notevole risparmio energetico.

Accensioni inferiori ad 1 ora (es. manutenzione) verranno ignorate ed il sistema non entra in funzione, per accensioni da 1 a 4 ore (es. anomalia impianto) o superiori alle 23 ore (es. impianto sempre acceso), il sistema resetta il timer quindi ricomincerà a contare per i primi 3 giorni e successivamente riprenderà il funzionamento automatico.

DYNA CONTROL is an automatic control system for the luminous flux of the lamps. The system comes into operation at the first start-up by calculating the ignition times for 3 days, on the fourth day the system autonomously calculates the virtual midnight by adjusting the flow by adjusting the lamp as indicated in the diagram in Fig. 1; for the first three days, therefore, the system will keep the lamps on at 100%, during the system start-up time, on the fourth day the DYNA CONTROL system will come into operation, independently managing the luminous flux thus ensuring significant energy savings.

Switch-ons of less than 1 hour (e.g. maintenance) will be ignored and the system does not start up, for switch-ons from 1 to 4 hours (e.g. system anomaly) or longer than 23 hours (e.g. system always on), the system resets the timer will then start counting again for the first 3 days and will then resume automatic operation.

Fig. 1 - Esempio applicativo 2 steps
Application example 2 steps

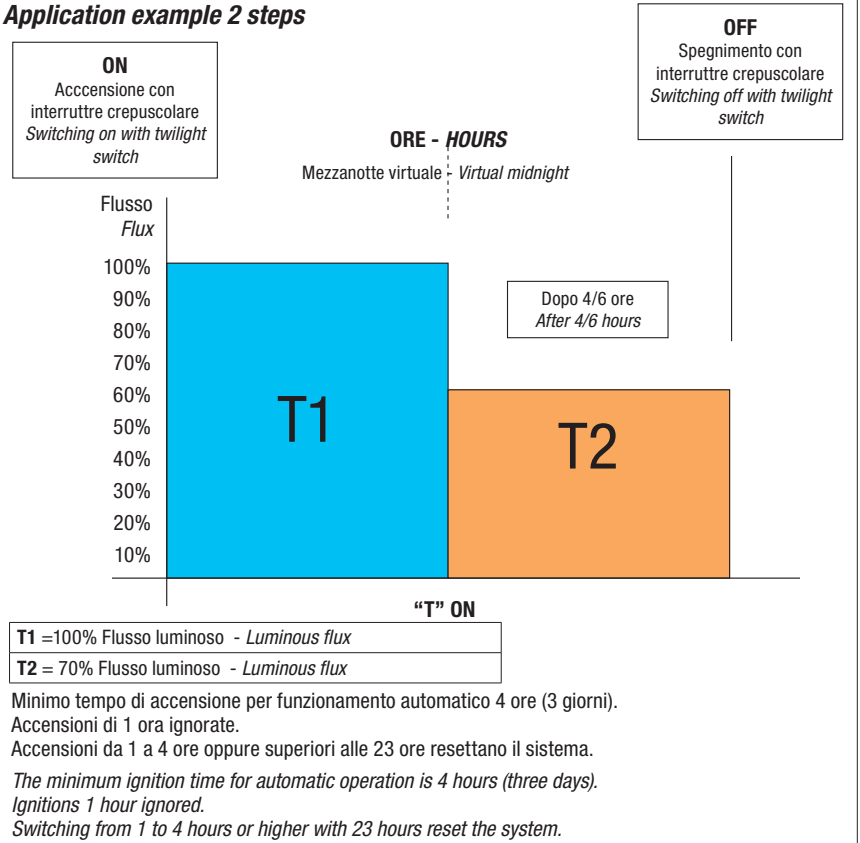

CLO - Constant Light Output

Tutte le fonti di luce (anche i LED) hanno una riduzione della produzione di luce nel corso del tempo. Per garantire il minimo richiesto di livelli di luce in un impianto, la maggior parte dei progetti di illuminazione sono calcolate in base al livello di luce alla fine della vita utile della lampada (di norma il punto L70: 70% dei Lumen iniziali). Ciò significa che il sistema consuma più potenza del necessario, sprecando in media 15% di energia durante la sua vita (Fig. A).

L'emissione luminosa funzionalità costante (CLO) compensa questa perdita di luce, in modo che i LED siano in grado di fornire sempre il livello di luce necessaria.

L'alimentatore può essere programmato per erogare corrente costante ad un livello ridotto per un nuovo apparecchio, ed aumentare gradualmente compensando il decadimento del flusso luminoso. Ciò influisce positivamente sulla vita della sorgente luminosa, sul risparmio energetico, prolungando la durata del sistema.

La regolazione della potenza erogata viene fatta in base al contatore delle ore di esercizio. Ad intervalli di tempo di 4.000 ore, il sistema incrementa la corrente del corrispondente valore di decadimento del flusso luminoso indicato dai costruttori della sorgente luminosa. In questo modo il flusso luminoso dell'apparecchio rimane costante per tutta la sua vita.

All light sources (including LEDs) produce less light over time. In order to guarantee the minimum required levels of light of a system, most lighting projects are planned taking into account the level of light at the end of the useful life of the lamp (normally point L70: 70% of initial lumen output). This means that the system consumes more power than necessary, wasting on average 15% of energy throughout its life (Fig. A).

The constant lumen output (CLO) compensates for this loss of light to ensure that the LEDs supply the required level of light at all times.

The power supply unit can be programmed to supply direct current at a reduced level for a new appliance, and to gradually increase this to compensate for the decline in luminous flux. This positively increases the lifespan of the light source and of the system, while ensuring energy savings.

The supply of power is adapted according to the operating hours counter. After every 4,000 hours, the system increases the current in proportion to the decrease in the luminous flux indicated by the manufacturers of the light source. In this way, the luminous flux of the appliance remains constant during its entire life-span.

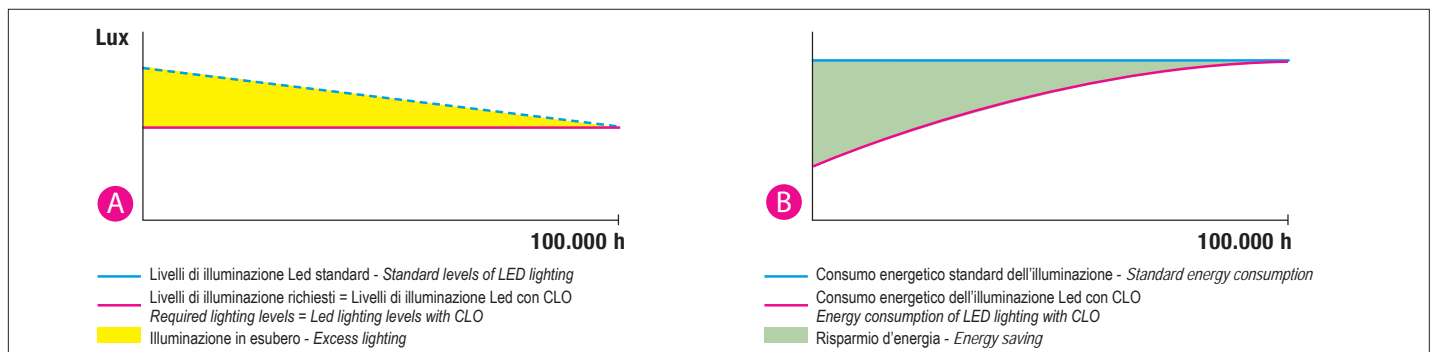

Smart City

Sistema di comunicazione Wireless

Possibilità di coimplementazione di diverse tecnologie
Programmazione e controllo da remoto mediante gateway in loco
Monitoraggio in tempo reale dello stato del sistema e raccolta dati
Idoneità al relamping per il risparmio energetico
Ideale per applicazioni commerciali, industriali ed ambienti esterni

Sistema estremamente efficiente, che combina soluzioni tecnologiche di prima qualità per il telecontrollo di luci e di oggetti IoT. Il sistema può monitorare, controllare e gestire le installazioni luminose, dalla singola lampada al network nel suo insieme.

Il sistema permette di coprire vaste aree e lo rende estremamente versatile in termini di compatibilità con una pluralità di dispositivi, è pensato per fornire soluzioni ad hoc sulla base delle necessità del singolo Cliente, copre una vasta gamma di applicazioni, che spaziano dalle aree commerciali agli edifici, dai capannoni industriali ai giardini pubblici, a città, strade e tunnel.

Impiegando diversi componenti è possibile gestire la luce a 360°, effettuare misurazioni di specifici parametri ambientali come l'inquinamento atmosferico, monitorare lo stato delle lampade (temperatura di funzionamento, consumi, eventuali difetti meccanici che potrebbero provocare danni ecc.) ed implementando sensori di movimento, creare heat map finalizzate alla definizione delle maggiori aree di concentrazione delle persone.

La programmazione dinamica della luce permette la gestione automatica del flusso luminoso della lampada in specifici intervalli di tempo. La funzione CLO consente di mantenere costante il flusso luminoso per tutta la durata di vita del prodotto, bilanciando elettronicamente la riduzione dell'efficienza tipica dei LED. Tutte le informazioni raccolte possono essere archiviate a gestire in loco o da remoto via Cloud.

Messa in opera e installazione del sistema non incluse nel prezzo.

Wireless communication system

Possibility of implementing several brand technologies
Remote programming and control via on-site gateways
Real-time monitoring of the system status and data collection
Suitable for energy saving relamping
Ideal for commercial, industrial and outdoor applications

Extremely efficient system, combining state-of the art- technological solution for the tele-control of light and objects. The system can monitor, control and manage the lighting installations ranging from the single lamp to the whole network.

The system allows to the cover extended areas makes it extremely versatile in terms of compatibility with a plurality of devices. This systems is thought to fulfil the need of providing and hoc solutions on the basis of the Customer requests. The system covers a very wide range of applications, ranging from commercial spaces to buildings, industrial plants, public gardens, cities, street and tunnels.

By implementing different components it is possible to manage the light at 360°; to make measurements of specific ambient parameters like air pollution and light intensity; to check the luminaire status (temperature, consumptions, any potentially dangerous mechanical faults etc..) and, by implementing movement sensors, to create heat maps aiming at defining the mains areas of people concentration.

All the collected information can be stored and managed on site or remotely via Cloud Service. The dynamic programming of the light enables to define an automatic management of the luminous flux emitted by the luminaire on the basis of time slots. The CLO function allows to keep the luminous flux constant along the life cycle of the luminaire, by electronically balancing the efficiency decrease, which is typical of the LEDs.

Installation and start-up of the system not included in the price



Smart City



Street furniture

INTERFACE DALI



- Interfaccia DALI
- Tensione nominale: 11÷30Vdc (0,05A max)
- Connettore presa Zhaga
- DALI BUS @ 24Vdc fino a 4 dispositivi

- Interface DALI
- Rated voltage: 11÷30Vdc (0,05A max)
- Zhaga socket connector
- DALI BUS @ 24Vdc up to 4 devices

ZHAGA SOCKET



Accessorio - Accessories

- Connettore max 30Vdc - max 1,5A - Connector max 30Vdc - max 1,5A
Code: 488787561
- Tappo IP66 - Cap connector IP66
Code: 488787581

LED Spluga - LED Maxispluga



La certificazione fotometrica dei nostri apparecchi viene sempre effettuata da un istituto esterno. Efficienza luminosa e "lm Output" sono quindi il risultato di tale istituto.

The photometric certification of our appliances is always carried out by an external institute. Luminous efficiency and "lm Output" are therefore the result of this institute.

A richiesta - On demand

1-10Vdc



DYNA

Wireless

Vedi Pag. VI - See page VI

Gamma di apparecchi a LED per illuminazione di aree urbane. Ideale per l'illuminazione di strade, parcheggi, aree residenziali.

Installazione: attacco palo in alluminio pressofuso idoneo per pali di diametro min. 55mm - max. 65mm, orientabile da ± 0 a $\pm 90^\circ$.

Corpo e telaio: in alluminio pressofuso UNI EN 1706 verniciato con polvere termoindurente poliestere.

Imbocco a palo: in alluminio pressofuso UNI EN 1706, verniciato con polvere termoindurente poliestere, con goniometro graduato per un corretto puntamento del fascio luminoso.

Ottica: In PMMA con resistenza alle alte temperature, agli shock termici e agli urti.

Verniciatura: di tipo poliestere eseguita a polvere, resistente agli agenti atmosferici e alla corrosione e garantita per 1.200 ore in nebbia salina (ISO 9227). Colore Nero RAL9005

Schermo: vetro temperato di spessore 4mm resistente agli shock termici e agli urti.

Sorgente: LED **SAMSUNG** 

Mantenimento del flusso luminoso minimo al 90% - 100.000h (L90B10) per il 90% dei LED.

Temperatura di colore: 4000K; altre temperature di colore a richiesta (2200K - 2700K - 3000K - 5000K - Consegna 60 giorni).

Protezione alle sovratensioni inclusa:

Modo differenziale 6kV (L-N)

Modo comune 8kV (L-GND, N-GND, L&N-GND)

A richiesta: versione con protezione maggiorata (10kV) contro gli impulsi aggiungendo il cod. R00640/N.

Driver: incorporato 

Fattore di potenza $\geq 0,98$.

Norme di riferimento: IEC 61000-4-5; EN60598-1; EN60598-2-1; EN62471; EN62031; EN60598-2-3; EN61547

Range of LED luminaires to light up urban areas. Suitable for roads, car parks and residential areas lighting.

Installation: pole attachment in die cast aluminium suitable for poles with a diameter of min. 55mm - max. 65mm, that can be pivoted ± 0 to $\pm 90^\circ$.

Housing and frame: made by UNI EN 1706 die-cast aluminium, coated with polyester thermoset powder.

Pole entrance: made by UNI EN 1706 die-cast aluminium, coated with polyester thermoset powder, with graduated goniometer to allow the correct orientation of light beam.

Optic: PMMA optic with high temperature resistance, thermal shock and impact resistance

Coating: coated with powdered polyester, resistant to atmospheric agents, corrosion and guaranteed for 1.200 hours in saline mist (ISO 9227). Black RAL 9005 color.

Shield: tempered glass with 4mm thickness resistant to thermal shocks and collisions.

Light source: LED **SAMSUNG** 

Maintenance of minimum luminous flux to 90% - 100.000h (L90B10) for 90% of LED.

Color temperature: 4000K; other color temperatures available on demand (2200K - 2700K - 3000K - 5000K. Delivery time: 60 days)

Protection against overvoltages included:

Differential mode 6kV (L-N)

Standard mode 8kV (L - GND, N-GND, L&N-GND).

On demand: this version with greater protection (10kV) with code R00640/N.

Driver: included 

Power factor $\geq 0,98$

Standard reference: IEC 61000-4-5; EN60598-1; EN60598-2-1; EN62471; EN62031; EN60598-2-3; EN61547



LED Maxispluga

LED Spluga

Il vano ottico è separato dal vano componenti per una migliore gestione termica e per evitare l'accesso al gruppo ottico in fase di installazione o manutenzione.

The optical compartment is separate from the component compartment for better thermal management and to avoid access to the optical unit during installation.

LED Spluga

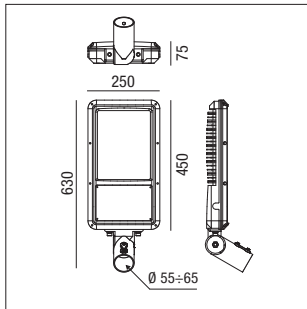

220-240 Vac	50/60 Hz	IP66	IK09	CRI >70	+40 C° -30	+50 C° -30 a richiesta on demand	RoHS compliance	850°
CE	17			RG0	DRIVER INCLUDED MULTIPOWER	LOW FLICKER	TECEE	

	colour	W	Optic	K	nominal lm tc = 25°C	lm output	lm/W	pcs	Kg	CELL
1-10Vdc	G	75	ST	4000	12.200	9.750	130	1	6,80	34504-5S
1-10Vdc	G	75	ST	3000	12.200	9.750	130	1	6,80	34504-5/3KS
1-10Vdc	G	75	ST	5000	12.200	9.750	130	1	6,80	34504/5000-5S
1-10Vdc	G	95	ST	4000	15.400	12.350	130	1	6,80	34506-5S
1-10Vdc	G	95	ST	3000	15.400	12.350	130	1	6,80	34506-5/3KS
1-10Vdc	G	95	ST	5000	15.400	12.350	130	1	6,80	34506/5000-5S
1-10Vdc	G	95	90°	4000	15.400	12.350	130	1	6,80	34506/90/955S

LED Maxispluga

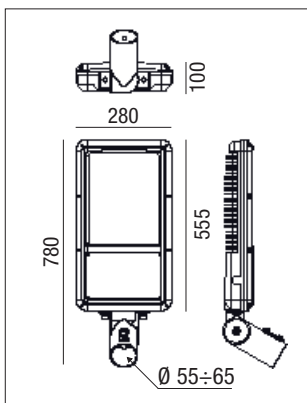

220-240 Vac	50/60 Hz	IP66	IK09	CRI >70	+40 C° -30	+50 C° -30 a richiesta on demand	RoHS compliance	850°
CE	17			RG0	DRIVER INCLUDED MULTIPOWER	LOW FLICKER	TECEE	

	colour	W	Optic	K	nominal lm tc = 25°C	lm output	lm/W	pcs	Kg	CELL
	G	120	ST	4000	19.500	15.600	130	1	10,00	34507-5
	G	120	ST	3000	19.500	15.600	130	1	10,00	34507-5/3K
1-10Vdc	G	140	ST	4000	22.750	18.200	130	1	10,00	34508-5S
1-10Vdc	G	140	ST	3000	22.750	18.200	130	1	10,00	34508-5/3KS
1-10Vdc	G	210	ST	4000	34.100	27.300	130	1	10,00	34509-5S
1-10Vdc	G	210	ST	3000	34.100	27.300	130	1	10,00	34509-5/3KS

A richiesta: potenze (W) intermedie - On demand: intermediate powers (W)

Ottica di serie Standard optic	Ottiche a richiesta Optics on demand
<p>ST/CDL Stradale - Street optic</p>	<p>ST/CDL1 Ottica stradale consigliata per strade con pista ciclabile Road optics recommended for roads with cycle tracks</p>
	<p>ST/CDL2 Ottica consigliata per illuminazione parchi Optics recommended for lighting in parks</p>
	<p>A richiesta è possibile fornire l'apparecchio con ottiche diverse da quelle già proposte On request, it is possible to supply the device with optics other than those already proposed</p>

Dettagli - Details



Il LED Driver è sempre certificato .
The Driver LED is always certified

Nel LED Driver è incluso il dispositivo di controllo della temperatura all'interno dell'apparecchio con ripristino automatico.

Protezione contro gli impulsi 8kV conforme alla Norma EN 61547.

The LED driver includes the temperature control device inside the device with automatic reset.

8kV Impulse protection in accordance with EN 61547.



Completo di connettore IP68 per una rapida installazione
Complete with IP68 connector for quick installation



A richiesta: verniciatura resistente a 2.000 ore di esposizione alla nebbia salina in accordo alla norma ISO 9227 certificato da Ente esterno.

On request: painting resistant to 2,000 hours of exposure to salt spray in accordance with ISO 9227 certified by an external body.



Ottiche: realizzate in PMMA resistente ai raggi UV
Optics: made in PMMA resistant to UV radiation



Dispositivo anticondensa: valvola di compensazione e riciclo dell'aria.

Anti-condensate device: valve for compensation and circulation of air.

Accessori non inclusi - Not included accessories



Code: RO0640/N

Dispositivo di protezione conforme alla Norma EN 61547 contro i fenomeni impulsivi atto a proteggere il modulo LED e il relativo alimentatore: classe II (a richiesta protezione fino a 10kV)

Protection device in compliance with the EN 61547 standard to counteract the impulsive phenomena designed to protect the LED module and the relative power supply: class II (protection up to 10kV available on request)



Cod. 802000.0101 - Braccio a parete - Wall bracket



LED Mini Gran Sasso - LED Gran Sasso - LED Maxi Gran Sasso



La certificazione fotometrica dei nostri apparecchi viene sempre effettuata da un istituto esterno. Efficienza luminosa e "lm Output" sono quindi il risultato di tale istituto.

The photometric certification of our appliances is always carried out by an external institute. Luminous efficiency and "lm Output" are therefore the result of this institute.

A richiesta - On demand

1-10Vdc DALI 2

DYNA Wireless

Vedi Pag. VI - See page VI

Gamma di apparecchi a LED per illuminazione di aree urbane. Ideale per l'illuminazione di strade, parcheggi, aree residenziali.

Installazione: attacco palo in alluminio pressofuso idoneo per pali di diametro min. 55mm - max. 65mm, orientabile da ± 0 a $\pm 90^\circ$.

Corpo e telaio: in alluminio pressofuso UNI EN 1706 verniciato con polvere termoidurente poliester.

Imbocco a palo: in alluminio pressofuso UNI EN 1706, verniciato con polvere termoidurente poliester, con goniometro graduato per un corretto puntamento del fascio luminoso.

Verniciatura: di tipo poliester eseguita a polvere, resistente agli agenti atmosferici e alla corrosione e garantita per 1.200 ore in nebbia salina (ISO 9227). Colore Nero RAL9005.

Schermo: vetro temperato di spessore 4mm resistente agli shock termici e agli urti.

Ottica: In PMMA con resistenza alle alte temperature, agli shock termici e agli urti.

Sorgente: LED **SAMSUNG**  Mantenimento del flusso luminoso minimo al 90% - 100.000h (L90B10) per il 90% dei LED.

Temperatura di colore: 4000K; altre temperature di colore a richiesta (2200K - 2700K - 3000K - 5000K - Consegna 60 giorni).

Protezione alle sovratensioni inclusa:
 Modo differenziale 6kV (L-N)
 Modo comune 8kV (L-GND, N-GND, L&N-GND)

A richiesta: versione con protezione maggiorata (10kV) contro gli impulsi aggiungendo il cod. RO0640/N.

Driver: incorporato 
 Fattore di potenza $\geq 0,98$.

Norme di riferimento: IEC 61000-4-5; EN60598-1; EN60598-2-1; EN62471; EN62031; EN60598-2-3; EN61547

Range of LED luminaires to light up urban areas. Suitable for roads, car parks and residential areas lighting.

Installation: pole attachment in die cast aluminium suitable for poles with a diameter of min. 55mm - max. 65mm, that can be pivoted ± 0 to $\pm 90^\circ$.

Housing and frame: made by UNI EN 1706 die-cast aluminium, coated with polyester thermoset powder.

Pole entrance: made by UNI EN 1706 die-cast aluminium, coated with polyester thermoset powder, with graduated goniometer to allow the correct orientation of light beam.

Coating: coated with powdered polyester, resistant to atmospheric agents, corrosion and guaranteed for 1.200 hours in saline mist (ISO 9227).

Black RAL 9005 color.

Shield: tempered glass with 4mm thickness resistant to thermal shocks and collisions.

Optic: PMMA optic with high temperature resistance, thermal shock and impact resistance

Light source: LED **SAMSUNG** 
 Maintenance of minimum luminous flux to 90% - 100.000h (L90B10) for 90% of LED.

Color temperature: 4000K; other color temperatures available on demand (2200K - 2700K - 3000K - 5000K. Delivery time: 60 days)

Protection against overvoltages included:
 Differential mode 6kV (L-N)
 Standard mode 8kV (L - GND, N-GND, L&N-GND).

On demand: this version with greater protection (10kV) with code RO0640/N.

Driver: included 
 Power factor $\geq 0,98$
Standard reference: IEC 61000-4-5; EN60598-1; EN60598-2-1; EN62471; EN62031; EN60598-2-3; EN61547

LED Mini Gran Sasso - LED Gran Sasso - LED Maxi Gran Sasso



LED Maxi Gran Sasso

NEW 2023

LED Gran Sasso

LED Mini Gran Sasso

Street furniture

220-240 Vac	110 Vac On demand	50/60 Hz	IP66	IK09	CRI > 70	+45 C° -30	CE			850°	
	TECEE	LOW FLICKER		RG0	DRIVER INCLUDED MULTIPOWER RIPPLE FREE	RoHS compliance		17 pending			

LED Mini Gran Sasso

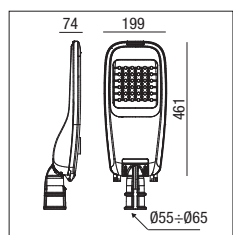

colour	W	Optic	K	nominal lm tc = 25°C	lm output	lm/W	pcs	Kg	CELL
N	20	ST	4000	3.150	2.835	140	1	2,20	346-20-4K
N	20	ST	3000	3.150	2.835	140	1	2,20	346-20-3K
N	30	ST	4000	4.615	4.150	138	1	2,20	346-30-4K
N	30	ST	3000	4.615	4.150	138	1	2,20	346-30-3K
N	40	ST	4000	6.075	5.468	136	1	2,20	346-40-4K
N	40	ST	3000	6.075	5.468	136	1	2,20	346-40-3K
N	50	ST	4000	7.425	6.680	134	1	2,20	346-50-4K
N	50	ST	3000	7.425	6.680	134	1	2,20	346-50-3K
DYNA	N	20	ST	4000	3.150	2.835	1	2,20	346-20-4K-DY
DYNA	N	20	ST	3000	3.150	2.835	1	2,20	346-20-3K-DY
DYNA	N	30	ST	4000	4.615	4.150	1	2,20	346-30-4K-DY
DYNA	N	30	ST	3000	4.615	4.150	1	2,20	346-30-3K-DY
DYNA	N	40	ST	4000	6.075	5.468	1	2,20	346-40-4K-DY
DYNA	N	40	ST	3000	6.075	5.468	1	2,20	346-40-3K-DY
DYNA	N	50	ST	4000	7.425	6.680	1	2,20	346-50-4K-DY
DYNA	N	50	ST	3000	7.425	6.680	1	2,20	346-50-3K-DY

LED Gran Sasso

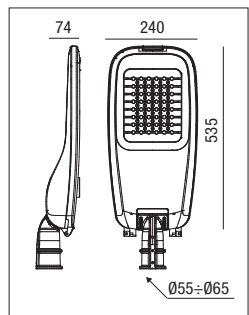

colour	W	Optic	K	nominal lm tc = 25°C	lm output	lm/W	pcs	Kg	CELL
N	60	ST	4000	9.225	8.300	138	1	3,60	346-60-4K
N	60	ST	3000	9.225	8.300	138	1	3,60	346-60-3K
N	75	ST	4000	11.250	10.125	137	1	3,60	346-75-4K
N	75	ST	3000	11.250	10.125	137	1	3,60	346-75-3K
N	90	ST	4000	13.500	12.150	135	1	3,60	346-90-4K
N	90	ST	3000	13.500	12.150	135	1	3,60	346-90-3K
DYNA	N	60	ST	4000	9.225	8.300	1	3,60	346-60-4K-DY
DYNA	N	60	ST	3000	9.225	8.300	1	3,60	346-60-3K-DY
DYNA	N	75	ST	4000	11.250	10.125	1	3,60	346-75-4K-DY
DYNA	N	75	ST	3000	11.250	10.125	1	3,60	346-75-3K-DY
DYNA	N	90	ST	4000	13.500	12.150	1	3,60	346-90-4K-DY
DYNA	N	90	ST	3000	13.500	12.150	1	3,60	346-90-3K-DY

A richiesta versione Zhaga Socket
On demand Zhaga Socket version



	colour	W	Optic	K	nominal lm tc = 25°C	lm output	lm/W	pcs	Kg	CELL
	N	120	ST	4000	19.000	16.600	138	1	4,50	346-120-4K
	N	120	ST	3000	19.000	16.600	138	1	4,50	346-120-3K
	N	140	ST	4000	22.000	19.200	137	1	5,00	346-140-4K
	N	140	ST	3000	22.000	19.200	137	1	5,00	346-140-3K
DYNA	N	120	ST	4000	19.000	16.600	138	1	4,50	346-120-4K-DY
DYNA	N	120	ST	3000	19.000	16.600	138	1	4,50	346-120-3K-DY
DYNA	N	140	ST	4000	22.000	19.200	137	1	5,00	346-140-4K-DY
DYNA	N	140	ST	3000	22.000	19.200	137	1	5,00	346-140-3K-DY

DYNA

DYNA

DYNA

DYNA

A richiesta versione Zhaga Socket
On demand Zhaga Socket version

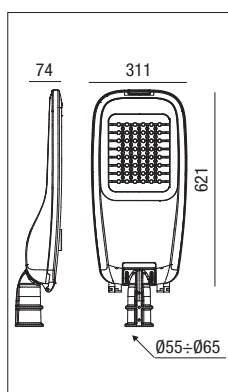

Ottica di serie
Standard optic

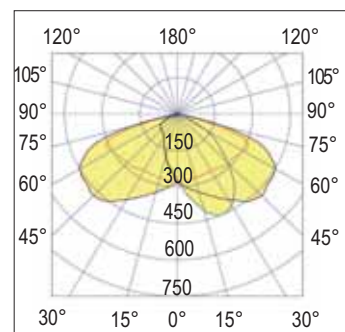

ST/CDL
Stradale - Street optic

Ottiche a richiesta
Optics on demand

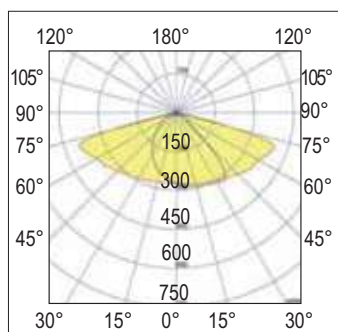

ST/CDL3
Ottica stradale consigliata per piste ciclabili
Street optic recommended for cycle paths

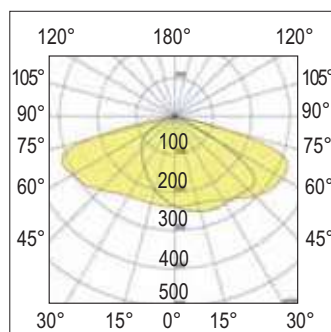

ST/CDL4
Ottica consigliata per illuminazione stradale
Optic recommended for street lighting

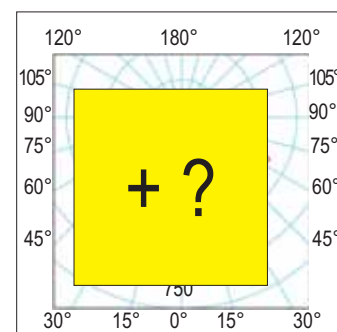

A richiesta è possibile fornire l'apparecchio con ottiche diverse da quelle già proposte
On request, it is possible to supply the device with optics other than those already proposed

Gestione del punto luce per un ulteriore risparmio di energia (richiedere preventivo) - Management of the lighting point for further energy savings (Request a quotation)

Regolazione 1÷10V 1-10V control	Mezzanotte virtuale Virtual midnight	Zhaga Socket	Telegestione sistema Wi-Fi (da concordare) Wi-Fi system remote management (to be agreed)
Possibilità di regolazione 10% - 100% con sistema 1÷10V Possibility of adjustment 10% - 100% with 1-10V system	Sistema con riduzione automatica del flusso System with automatic flux reduction	Predisposizione sul corpo dell'apparecchio. Ideale per la gestione dell'illuminazione autonoma locale tramite sensori o da remoto. For installation on the body of the appliance. Ideal for autonomous management of the lighting, either locally with sensors or remotely	Sistema di controllo, gestione consumi e diagnosi dell'impianto con tecnologia Wi-Fi Control system, consumption management and diagnosis of the system with Wi-Fi technology

LED Mini Gran Sasso - LED Gran Sasso - LED Maxi Gran Sasso

Gestione del punto luce per un ulteriore risparmio di energia (richiedere preventivo) - Management of the lighting point for further energy savings (Request a quotation)

Mezzanotte virtuale - Virtual midnight

Sistema con riduzione automatica del flusso - System with automatic flux reduction

DYNA control - Mezzanotte virtuale Virtual midnight

Settaggio del flusso luminoso: avviene tramite programmazione della corrente di pilotaggio da richiedere in sede in fase d'ordine / progetto
Luminous flux setting: takes place by programming the driving current to be requested at the time of the order / project

DYNA CONTROL è un sistema automatico di controllo del flusso luminoso delle lampade. Il sistema entra in funzione alla prima accensione calcolando per 3 giorni i tempi di accensione, il quarto giorno il sistema in modo autonomo calcola la mezzanotte virtuale eseguendo una regolazione del flusso regolando la lampada come indicato sullo schema di Fig. 1; per i primi tre giorni quindi il sistema manterrà le lampade accese al 100%, nel tempo di accensione dell'impianto, il quarto giorno entrerà in funzione il sistema DYNA CONTROL gestendo in modo autonomo il flusso luminoso garantendo così un notevole risparmio energetico. Accensioni inferiori ad 1 ora (es. manutenzione) verranno ignorate ed il sistema non entra in funzione, per accensioni da 1 a 4 ore (es. anomalia impianto) o superiori alle 23 ore (es. impianto sempre acceso), il sistema resetta il timer quindi ricomincerà a contare per i primi 3 giorni e successivamente riprenderà il funzionamento automatico.

DYNA CONTROL is an automatic system to control lamp brightness. The system starts working when first switched-on calculating switch-on times for 3 days, on the fourth day the system autonomously calculates the virtual midnight, adjusting the brightness of the lamp as indicated in fig.1. Therefore, for the first three days the system will keep the lamps on at 100%, during system switch-on, on the fourth day, the DYNA CONTROL system will start operating autonomously, controlling the lamp's brightness, thus ensuring significant energy savings.

Switch-on of less than 1 hour (ex. for maintenance) will be ignored and the system will not operate. For switch-on times from 1 to 4 hours (ex. system anomaly) or over 23 hours (ex. system always on), the system resets the timer and will restart counting for the first 3 days and then resume to automatic operation.

Fig. 1 - Esempio applicativo 5 steps - Application example 5 steps

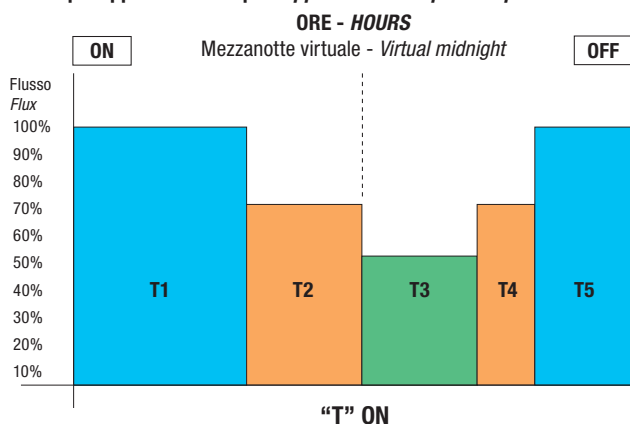

T1 = 30% "T" - 100% Flusso luminoso - Luminous flux
T2 = 20% "T" - 70% Flusso luminoso - Luminous flux
T3 = 20% "T" - 50% Flusso luminoso - Luminous flux
T4 = 10% "T" - 70% Flusso luminoso - Luminous flux
T5 = 20% "T" - 100% Flusso luminoso - Luminous flux

Minimo tempo di accensione per funzionamento automatico 4 ore (3 giorni).
 Accensioni di 1 ora ignorate.
 Accensioni da 1 a 4 ore oppure superiori alle 23 ore resettano il sistema.
 The minimum ignition time for automatic operation is 4 hours (three days).
 Ignitions 1 hour ignored.
 Switching from 1 to 4 hours or higher with 23 hours reset the system.

Street furniture



Il LED Driver è sempre certificato
 The Driver LED is always certified

Nel LED Driver è incluso il dispositivo di controllo della temperatura all'interno dell'apparecchio con ripristino automatico.

Protezione contro gli impulsi 8kV conforme alla Norma EN 61547

The LED driver includes the temperature control device inside the device with automatic reset.

8kV Impulse protection in accordance with EN 61547.

Classi di intensità CEN (classificazione provvisoria) e valore stimato del relativo ULOR massimo - CEN intensity classes (provisional classification) and estimated value of its maximum ULOR

Class	70truept	80truept	90truept	95truept	
Prelim.	70truept	80truept	90truept	95truept	
G1		200 cd/klm	50 cd/klm		~ 31%
G2		150 cd/klm	30 cd/klm		~ 18,8%
G3		100 cd/klm	20 cd/klm		~ 12,6%
G4	500 cd/klm	100 cd/klm	10 cd/klm	0 cd/klm	~ 0,55%
G5	350 cd/klm	100 cd/klm	10 cd/klm	0 cd/klm	~ 0,55%
G6	350 cd/klm	100 cd/klm	0 cd/klm	0 cd/klm	0%



ST/CDL
ST1,1 - l = 12h / d = 1,1 Intensity class: G*3
ST0,9 - l = 15h / d = 0,9 / h <= 16 Intensity class: G*3
ST1,3 - l = 10h / d = 1,3 Intensity class: G*3



ST/CDL3
ST3 - l = 15h / d = 3 Intensity class: G*3
ST3,2 - l = 16h / d = 3,2 / h <= 16 Intensity class: G*3
ST2,4 - l = 12h / d = 2,4 Intensity class: G*3



ST/CDL4
ST1,3 - l = 10h / d = 1,3 Intensity class: G*3
ST1 - l = 13h / d = 1 / h <= 15 Intensity class: G*3
ST1,15 - l = 15h / d = 1,15 Intensity class: G*3

d = L/h	L = Largezza zona da illuminare Width of the area to be illuminated
h = Altezza installazione Height to be illuminated	l = Interdistanza pali Interdistance between poles

LED Mini Gran Sasso - LED Gran Sasso - LED Maxi Gran Sasso

Dettagli - Details



Completo di connettore IP68 per una rapida installazione
Complete with IP68 connector for quick installation



Dispositivo anticondensa: valvola di compensazione e riciclo dell'aria.
Anti-condensate device: valve for compensation and circulation of air.

Accessori non inclusi - Not included accessories



Dispositivo di protezione conforme alla Norma EN 61547 contro i fenomeni impulsivi atto a proteggere il modulo LED e il relativo alimentatore: classe II fino a 10kV

Protection device in compliance with the EN 61547 standard to counteract the impulsive phenomena designed to protect the LED module and the relative power supply: class II protection up to 10kV

Code: RO0640/N

PROTEZIONE ALLE SOVRATENSIONI

In un impianto elettrico standard un apparecchio a LED può essere sottoposto a sbalzi di tensione e disturbi esterni dovuti a fattori quali carichi discontinui sulla linea, guasti sulle linee a monte o a valle e, soprattutto, scariche atmosferiche (negli impianti esterni).

Nei nostri proiettori, dove l'elettronica è fondamentale, la resistenza alle sovratensioni è sinonimo di affidabilità e corretta funzionalità.

Sovratensioni

Le sovratensioni sono un rapido innalzamento della differenza di potenziale tra le diverse polarità (Fase o Neutro) e la Terra, in alcuni casi sono talmente elevate da superare la soglia di isolamento dei componenti elettronici causandone così il danneggiamento. Esistono anche casi di sovratensioni di entità inferiore, le quali non provocano un immediato guasto dei moduli LED o driver privi di protezione, ma se nel tempo si verificano ripetutamente possono provocare il deterioramento dei LED, di conseguenza, una durata ridotta. Nel caso di sovratensioni di elevata entità, come la caduta dei fulmini, provocano invece un guasto immediato dei moduli LED o dei driver. Le sovratensioni, di fatto, provocano degli impulsi di energia con correnti elevate sia nel driver che nei moduli LED.

SURGE PROTECTOR

In a standard electrical system an LED luminaire can be subjected to voltage fluctuations and external disturbances due to factors such as discontinuous loads on the line, faults on the lines upstream or downstream and, especially, atmospheric discharges (in External Plants).

In our projectors, where electronics is very important, the surge resistance is synonymous with reliability and proper functionality.

Overvoltages

Overvoltages are a rapid rise in the potential difference between the different polarities (Phase or Neutral) and the Earth, in some cases they are so high as to exceed the isolation threshold of the electronic components, thus causing damage. There are also cases of minor overvoltages, which do not cause an immediate failure of the unprotected LED modules or drivers, but if they occur repeatedly over time they can cause deterioration of the LEDs, consequently a reduced life span. In the event of high voltage surges, such as lightning strikes, they cause immediate failure of the LED modules or drivers. The overvoltages, in fact, cause energy pulses with high currents in both the driver and the LED modules.

ZHAGA SOCKET



Accessorio - Accessories

- Connettore max 30Vdc - max 1,5A - Connector max 30Vdc - max 1,5A

Code: 488787561

- Tappo IP66 - Cap connector IP66

Code: 488787581



- Interfaccia DALI

- Tensione nominale:

11÷30Vdc (0,05A max)

- Connettore presa Zhaga

- DALI BUS @ 24Vdc fino

a 4 dispositivi

- Interface DALI

- Rated voltage: 11÷30Vdc (0,05A max)

- Zhaga socket connector

- DALI BUS @ 24Vdc up

to 4 devices

LED Monza round

Outdoor



Sistema LED lineare per applicazioni professionali nell'illuminazione di facciate, portici, sottopassaggi e in generale per l'illuminazione di particolari elementi architettonici. A richiesta è possibile collegare gli apparecchi in serie per ottenere delle linee di luce continua.

Installazione: su superfici verticali e orizzontali (completo di staffa di fissaggio).

Corpo: in policarbonato trasparente, resistente agli urti.

Testate di chiusura: in PVC, colore nero

Staffa di fissaggio: in alluminio, verniciata con polvere termoindurente poliestere

Guarnizione: in gomma ai siliconi dalle rilevanti prestazioni meccaniche ed elastiche

Dispositivo anticondensa: valvola di compensazione e riciclo dell'aria

Norme di riferimento

EN60598-1; EN60598-2-1; EN62471; EN62031; EN61547

Sorgente: **SAMSUNG - CREE**

Mantenimento del flusso luminoso minimo al 80% - 50.000h (L80B10) per il 90% dei LED.

Temperatura di colore: 2200K, 3000K e 4000K

Cablaggio: 1,5m di cavo tipo H07RN-F 2x1mm²

Driver: incorporato  Fattore di potenza ≥0,95

LED linear system for professional lighting applications on facades, arcades, tunnels and generally to light up particular architectural elements. On demand it is possible to make a serial connection of the luminaires to have continuous light lines. The very low energy consumption and a lifespan exceeding 30.000 hours make the profiles ideal both for installations in new electrical systems and replacement of luminaires with traditional light sources.

Installation: on vertical and horizontal surfaces (complete with fixing bracket)

Housing: made by transparent polycarbonate, resistant to collisions

End caps: made by PVC, black color

Fixing bracket: made by aluminum, coated with polyester thermoset powder

Gasket: made by silicone rubber with high mechanical and elastic performance

Anti-condensate device: valve for compensation and circulation of air

Standard reference

EN60598-1; EN60598-2-1; EN62471; EN62031; EN61547

Light source: **SAMSUNG - CREE**

Maintenance of 80% minimum luminous flux: 50,000h (L80B10) for 90% of the LEDs.

Color temperature: 2200K, 3000K and 4000K

Wiring: 1,5m cable type H07RN-F 2x1mm²

Driver: included  Power factor ≥0,95

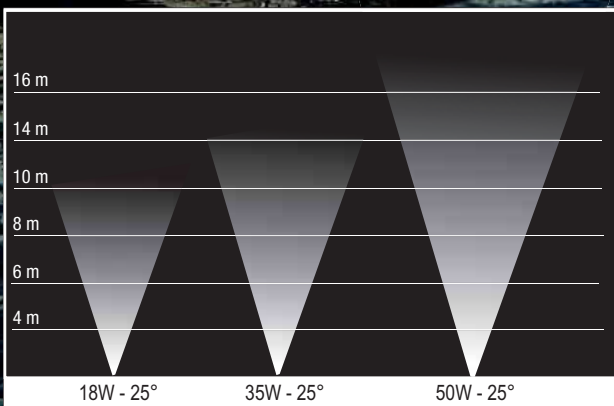

A richiesta
On demand

1-10Vdc

Pag. VI



Pag. VI

220-240 Vac	110 Vac On demand	50/60 Hz	IP67	IK09	CRI > 80	+40 C -20	850°	CE		
Driver included 		DIM a richiesta on demand 								

LED Monza round 70 Wall Washer - LED Monza round 100

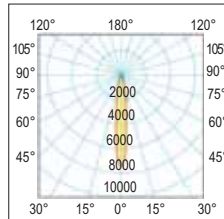

10°
Concentrate
Narrow
Schermo trasparente standard
Standard transparent shield

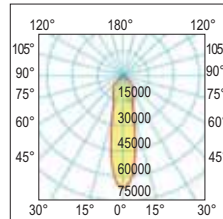

25°
Semi-concentrate
Spot
Schermo trasparente standard
Standard transparent shield



LED Monza round 70 Wall Washer

colour	W	angle	K	nominal lm tc = 25°C	lm output	lm/W	pcs	Kg	CELL
T	18	10°	3000	2600	2160	120	1	0,92	27334/R/10/3K
T	18	10°	4000	2600	2160	120	1	0,92	27334/R/10
T	18	25°	3000	2600	2160	120	1	0,92	27334/R/3K
T	18	25°	4000	2600	2160	120	1	0,92	27334/R

A richiesta: per quantità minima 100 pezzi disponibili a 2200K - On demand: for quantity min 100 pcs available 2200K

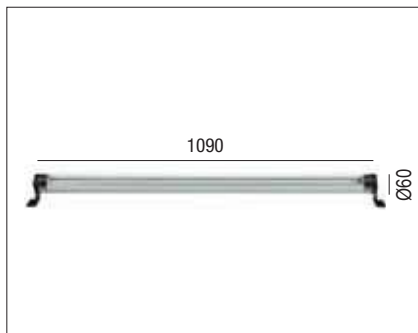

LED Monza round 100

colour	W	angle	K	nominal lm tc = 25°C	lm output	lm/W	pcs	Kg	CELL
T	35	10°	3000	5040	4200	120	1	1,20	27339/R/10/3K
T	35	10°	4000	5040	4200	120	1	1,20	27339/R/10
T	35	10°	4000	5040	4200	120	1	1,20	27339/R/10/DA
T	35	25°	3000	5040	4200	120	1	1,20	27333/R/3K
T	35	25°	4000	5040	4200	120	1	1,20	27333/R
T	50	10°	4000	6300	5500	110	1	1,20	27339/R/10/50
T	50	25°	4000	6300	5500	110	1	1,20	27339/R/25/50

A richiesta: per quantità minima 100 pezzi disponibili a 2200K - On demand: for quantity min 100 pcs available 2200K

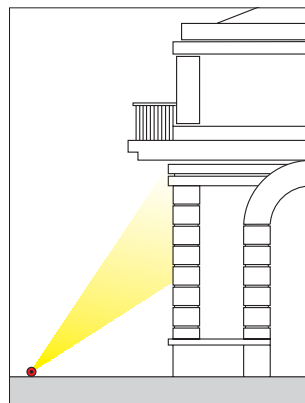
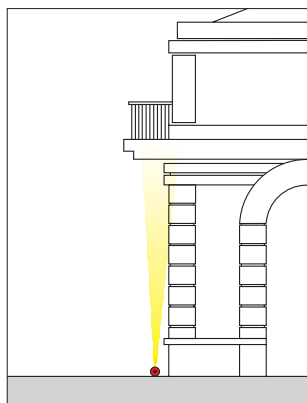
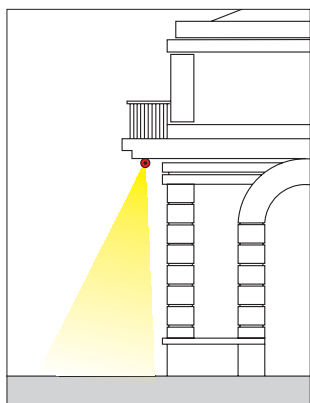
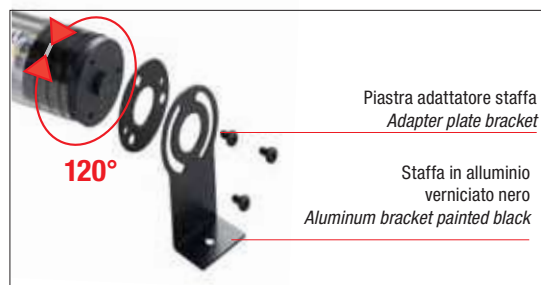

LED Tuba Lux

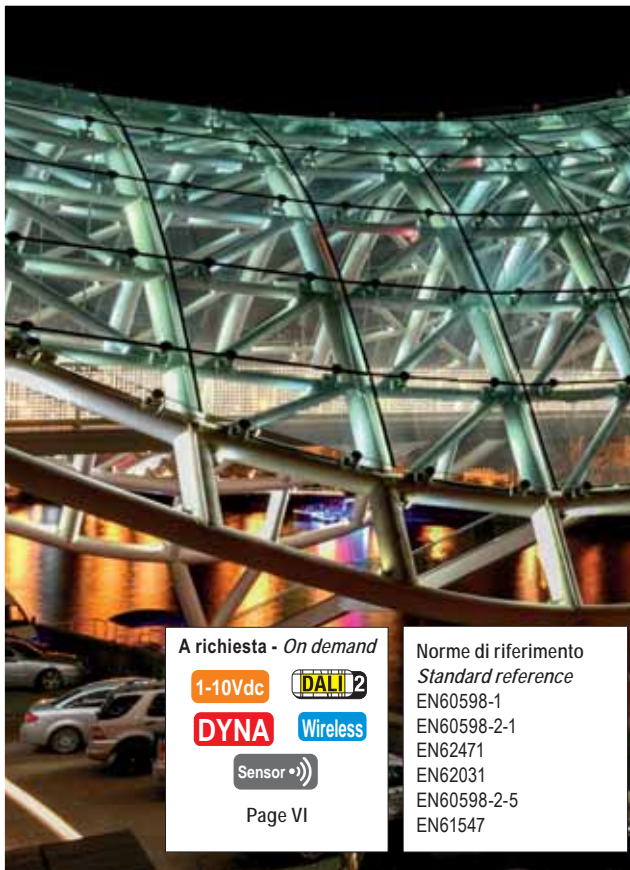

A richiesta - On demand

1-10Vdc DALI2

DYNA Wireless

Sensor

Page VI

Norme di riferimento
Standard reference

EN60598-1
EN60598-2-1
EN62471
EN62031
EN60598-2-5
EN61547

Sistema LED lineare per applicazioni professionali nell'illuminazione di facciate, portici, sottopassaggi e in generale per l'illuminazione di particolari elementi architettonici. A richiesta è possibile collegare gli apparecchi in serie per ottenere delle linee di luce.

Installazione: su superfici verticali e orizzontali (completo di staffa di fissaggio).

Corpo: in policarbonato trasparente o opale, resistente agli urti.

Testate di chiusura: in acciaio Inox

Staffa di fissaggio: in acciaio Inox

Guarnizione: in gomma ai siliconi dalle rilevanti prestazioni meccaniche ed elastiche

Dispositivo anticondensa: valvola di compensazione e riciclo dell'aria

Sorgente: **SAMSUNG - CREE**

Mantenimento del flusso luminoso minimo al 80% - 50.000h (L80B10) per il 90% dei LED.

Temperatura di colore: 4000K; altre temperature di colore a richiesta

Cablaggio: 1.250cm di cavo tipo H07RN-F 2x1mm²

Driver: incorporato . Fattore di potenza ≥0,95

LED linear system for professional lighting applications on facades, arcades, tunnels and generally to light up particular architectural elements. On demand it is possible to make a serial connection of the luminaires to have light lines. The very low energy consumption and a life-span exceeding 30.000 hours make the profiles ideal both for installations in new electrical systems and replacement of luminaires with traditional light sources.

Installation: on vertical and horizontal surfaces (complete with fixing bracket)

Housing: made by transparent or opal polycarbonate, resistant to collisions

End caps: made in Inox steel

Fixing bracket: made Inox steel

Gasket: made by silicone rubber with high mechanical and elastic performance

Anti-condensate device: valve for compensation and circulation of air

Light source: **SAMSUNG - CREE**

Maintenance of 80% minimum luminous flux: 50,000h (L80B10) for 90% of the LEDs.

Color temperature: 4000K; other color temperatures available on demand

Wiring: 1.250cm cable type H07RN-F 2x1mm²

Driver: included . Power factor ≥0,95

Outdoor

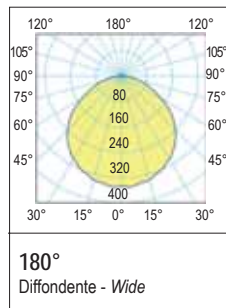
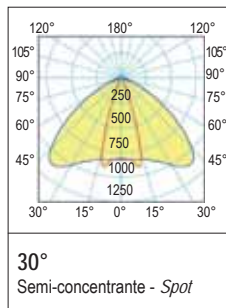

220-240 Vac 110 a richiesta on demand Vac 50/60 Hz IP67 IK09 CRI >80 +40 C° -20 C° +50 C° -20 C° a richiesta on demand

 850° DRIVER INCLUDED

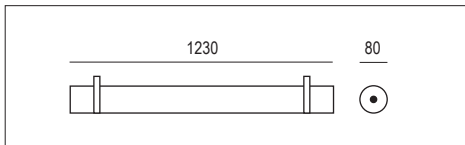

colour	W	angle	K	nominal lm tc = 25°C	lm output	lm/W	pcs	Kg	CELL
T	50	30°	3000	6.250	5.000	100	1	2,00	27339/TU/TR3K
T	50	30°	4000	6.250	5.000	100	1	2,00	27339/TUBA/TR
OP	50	180°	3000	5.000	4.000	80	1	2,00	27339/TU/OP3K
OP	50	180°	4000	5.000	4.000	80	1	2,00	27339/TUBA/OP

Accessori non inclusi - Not included accessories



Cod. XY10-2P
Connettore IP68 per una rapida installazione
IP68 connector for quick installation



Cod. 31300
Kit per installazione a sospensione LED Tuba Lux - Lunghezza cavi 2m
LED Tuba Lux Suspension installation kit - Cable lenght 2m

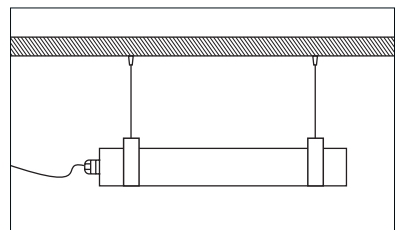

LED Positano

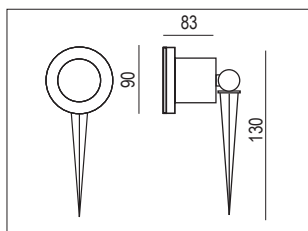

Norme di riferimento
Standard reference
 EN60598-1
 EN60598-2-1
 EN62471
 EN62031
 EN60598-2-5
 EN61547

Faretto ad illuminazione d'accento concepito per l'illuminazione di aree esterne. Costituisce uno strumento efficace per l'illuminazione di arredi, percorsi, porticati ed altri elementi architettonici, ma anche gruppi di vegetazione come alberi e cespugli.

Corpo: materiale termoplastico

Schermo: vetro temprato resistente agli shock termici e agli urti

Cablaggio: completo di cavo 3m (VDE H05RR-F - 2x1mm²) e spina Schuko

Sorgente: lampadina LED GU10

Accessori inclusi: picchetto, staffa di fissaggio a parete e lampadina

Spot-light with accentuated lighting for use in indoor or outdoor where a high degree IP protection is required.

It is an efficient means of lighting objects, parths, porches and other architectural features, as well as vegetation such a trees and shrubs.

Housing: thermoplastic material

Shield: tempered glass resistant against thermal shocks and collision

Wiring: complete with 3m wire (VDE H05RR-F - 2x1mm²) and schuko plug

Source: GU10 LED lamp

Included accessories: spike, wall fitting bracket and lamp

220-240 Vac	50/60 Hz	IP66	IK08	CRI >80	+40 C -20			
colour	W	LED	K	lm	pcs	Kg	S + L	
N	6	Led GU10 lamp	4000	450	1	0,80	02012/LEDGU10	
N	6	Led GU10 lamp	3000	450	1	0,80	02013/LEDGU10	



Outdoor

LED Gargano

Outdoor



LED Gargano è un apparecchio da esterno, ad alto grado di protezione, utilizzabile sia tramite fissaggio che ad incasso ideale per giardini, parchi, aiuole, terrazzi, corselli per piscine.

Installazione: incassi a pavimento adatti per illuminare percorsi pedonali, aree verdi, porticati, edifici sia residenziali che pubblici.

Corpo: corpo in alluminio pressofuso. Verniciatura di tipo poliestere eseguita a polvere resistente agli agenti atmosferici e alla nebbia salina. Viterie in acciaio Inox AISI 316L.

Ghiera: alluminio. Verniciatura di tipo poliestere eseguita a polvere resistente agli agenti atmosferici e alla nebbia salina.

Diffusore: vetro temperato resistente agli shock termici ed agli urti.

Guarnizione: in gomma silconica

Sorgente: LED 5050 **SAMSUNG**

Colori: disponibile nel colore verniciato nero RAL 9005 e grigio RAL 9006

Carrabilità: sistema carrabile fino a 10Km/h - 1t

Driver: box esterno IP67 con driver e interfaccia controller DMX.

LED Gargano is a luminaire for outdoor use, with high protection degree, for fixed or recessed installation, for gardens, parks, flowerbeds, terraces, swimming pools (NOT immersion).

Installation: floor recessed luminaires suitable for illuminating pedestrian paths, green areas, porches, buildings either public or domestic.

Body: die-cast aluminium body. Polyester powder coating. Resistance to atmospheric agents and corrosion guaranteed in saline mist. Screws in stainless steel AISI 316L.

Ring: aluminium. Polyester powder coating. Resistance to atmospheric agents and corrosion guaranteed in saline mist.

Diffuser: impact and shock-resistant tempered glass.

Gasket: silicone rubber

*Light source: LED 5050 **SAMSUNG***

Colours: Available in RAL 9005 black and RAL 9006 grey painted version.

Drive-over: up to 10Km/h - 1t

Driver: IP67 external box with driver and DMX controller interface

Norme di riferimento
Standard reference
EN60598-1
EN60598-2-1
EN62471
EN62031
EN60598-2-5
EN61547



LED Gargano

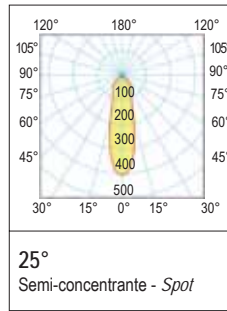

220-240 Vac 50/60 Hz IP67 IK10 CRI >80 +40°C / -20°C 850°

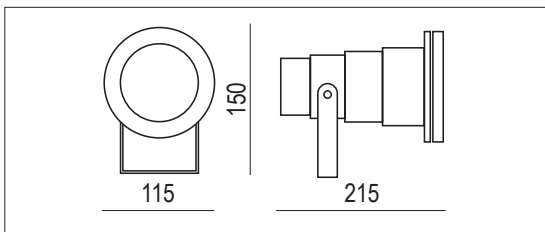

colour	W	angle	K	lm Output	pcs	Kg	CELL
N	10	25°	4000	914	1	0,80	24285/LED
N	10	25°	3000	914	1	0,80	24286/LED
G	10	25°	3000	914	1	0,80	24290/LED
G	10	25°	4000	914	1	0,80	24284/LED
N	4	45°	3000	400	1	0,80	24280/LEGU10

A richiesta: per quantità disponibile versione 2700K e 5000K - On demand: for quantity, available 2700K and 5000K version

Accessori non inclusi - Not included accessories



Cassaforma per installazione a pavimento Framework for floor installation				
colour	H (mm)	pcs	Kg	S
N	240	1	1,00	24134
G	240	1	1,00	24135



Frangiluce - Louver				
colour	Ø (mm)	pcs	Kg	S
N	150	1	1,00	24136
G	150	1	1,00	24137



Frangiluce - Louver				
colour	Ø (mm)	pcs	Kg	S
N	150	1	1,00	24138
G	150	1	1,00	24139



Outdoor



Cod. 24165
Picchetto in alluminio
Aluminium spike



IP68
Cod. THR209
Accessorio IP68, 4 vie per linee di luce continua
4-way IP68 accessory for continuous light lines.



IP68
Cod. 12370
Big box - IP68
1 Entrata / 5 Uscite
1 Input / 5 Outputs

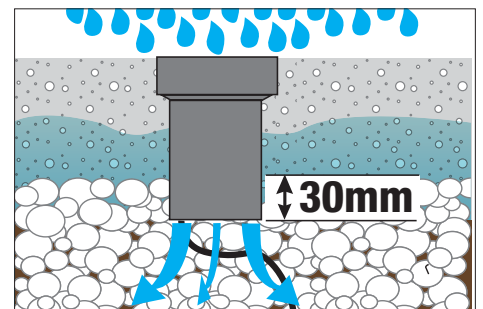

Al fine di permettere un adeguato drenaggio si consiglia di preparare un fondo di ghiaia in fase di installazione. Per il collegamento è necessario utilizzare connettori stagni.
We advise you to prepare a gravel drain fund for installing the products, to ensure suitable drainage. For the connection it is necessary to use waterproof connectors.

LED Capri - LED Capri Mini



LED Capri è un apparecchio da esterno, ad alto grado di protezione, utilizzabile sia tramite staffa di fissaggio da terra o parete (inclusa) che con picchetto (da ordinare separatamente), ideale per illuminare facciate giardini, parchi, aiuole, terrazzi.

Corpo e telaio: in alluminio pressofuso UNI EN 1706 verniciato con polvere termoindurente poliester

Staffa di fissaggio: in acciaio, verniciata con polvere termoindurente poliester

Verniciatura: di tipo poliester eseguita a polvere, resistente agli agenti atmosferici e alla corrosione e garantita per 1.000 ore in nebbia salina. Colore Nero RAL 9005.

Schermo: vetro temprato di spessore 4mm resistente agli shock termici e agli urti.

Driver: incorporato

Sorgente: LED **CREE** Fattore di potenza $\geq 0,92$. Mantenimento del flusso luminoso al 80%. 50.000h (L80B20).

The Capri LED is an outdoor appliance with a high degree of protection, which can also be used with a floor or wall fixing bracket (included) or with a stake (to be ordered separately), ideal for illuminating façades in gardens, parks, flowerbeds, terraces.

Housing and frame: made by UNI EN 1706 die-cast aluminum, coated with polyester thermoset powder

Fixing bracket: made by stainless steel, coated with polyester thermoset powder

Coating: coated with powdered polyester, resistant to atmospheric agents, corrosion and guaranteed for 1.000 hours in saline mist. Black RAL9005 color.

Optic: clumping

Shield: tempered glass with 4mm thickness resistant to thermal shocks and collisions

Driver: included

*Light source: LED **CREE** Power factor $\geq 0,92$. maintenance of 80% minimum luminous flux: 50,000h (L80B20).*

Outdoor

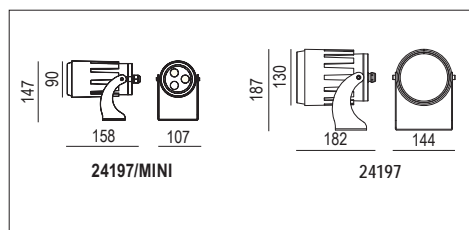
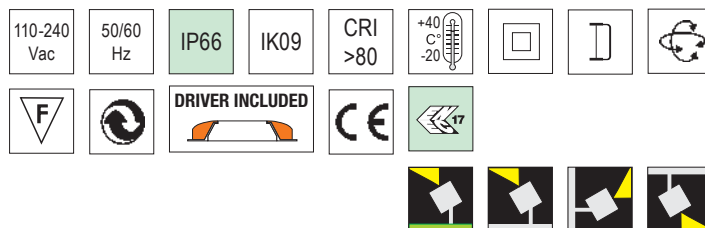

Norme di riferimento
Standard reference
EN60598-1
EN60598-2-1
EN62471
EN62031
EN60598-2-5
EN61547

colour	W	Optic	K	lm	pcs	Kg	CELL
N	9	30°	4000	710	1	1,30	24197/MINI
N	27	30°	4000	2230	1	1,60	24197



Accessori non inclusi
Not included accessories



Cod. 24165
Picchetto in alluminio
NON INCLUSO
NOT INCLUDED
ACCESSORY
aluminium spike

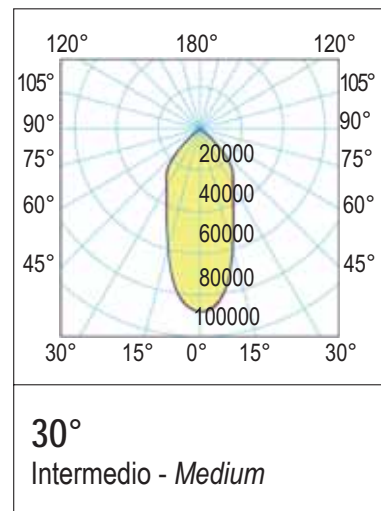

LED Capri - LED Capri Mini



Outdoor

LED Ischia



LED Ischia è un apparecchio da esterno, ad alto grado di protezione, utilizzabile sia tramite staffa di fissaggio da terra o parete (inclusa), con picchetto (da ordinare separatamente) o da palo (da ordinare separatamente), ideale per illuminare facciate giardini, parchi, aiuole, terrazzi.

Corpo e telaio: in alluminio pressofuso UNI EN 1706 verniciato con polvere termoindurente poliestere

Verniciatura: di tipo poliestere eseguita a polvere, resistente agli agenti atmosferici e alla corrosione e garantita per 1.000 ore in nebbia salina. Colore Nero RAL 9005.

Ottica: con lenti in PC ad alto confort visivo e buon effetto antiriflesso.

Schermo: vetro temprato di spessore 4mm super bianco resistente agli shock termici e agli urti.

Driver: incorporato

Sorgente: LED Fattore di potenza $\geq 0,92$. Mantenimento del flusso luminoso al 80%. 50.000h (L80B20)

A richiesta: DALI 2 e DMX.

Norme di riferimento: EN60598-1; EN60598-2-1; EN62471; EN62031; EN60598-2-5; EN61547

The Capri LED is an outdoor appliance with a high degree of protection, which can also be used with a floor or wall fixing bracket (included) or with a stake (to be ordered separately), ideal for illuminating façades in gardens, parks, flowerbeds, terraces.

Housing and frame: made by UNI EN 1706 die-cast aluminum, coated with polyester thermoset powder

Coating: coated with powdered polyester, resistant to atmospheric agents, corrosion and guaranteed for 1.000 hours in saline mist. Black RAL9005 color.

Optic: with PC lenses with high visual comfort and good anti glare effect

Shield: tempered glass with 4mm thickness super white resistant to thermal shocks and collisions

Driver: included

Light source: LED Power factor $\geq 0,92$. maintenance of 80% minimum luminous flux: 50,000h (L80B20).

On demand: DALI 2 and DMX.

Standard reference: EN60598-1; EN60598-2-1; EN62471; EN62031; EN60598-2-5; EN61547

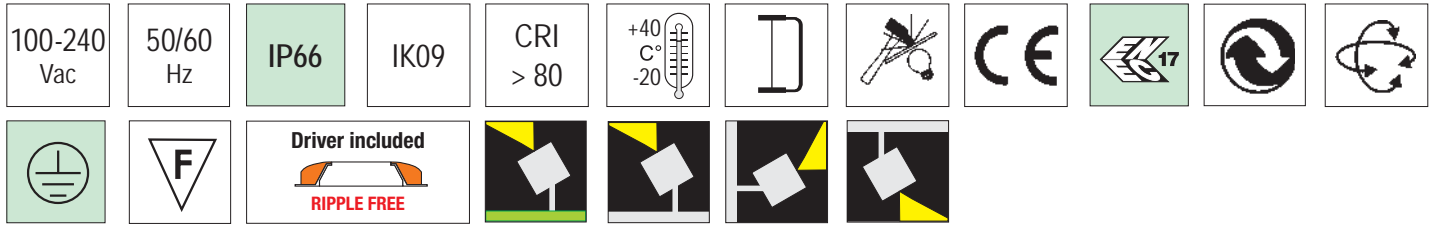

LED Ischia 1

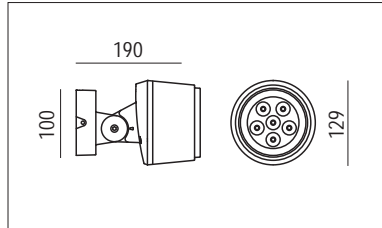

Orientabilità
inclinazione del corpo
lampada $\pm 90^\circ$
Adjustability
inclination of the lamp
body $\pm 90^\circ$

colour	W	Optic	K	Lm/W	lm Output	pcs	Kg	CELL
N	18	40°	3000	130	2600	1	1,80	215-18-40-3K
N	18	40°	2200	130	2400	1	1,80	215-18-40-2K
N	18	40°	4000	130	2600	1	1,80	215-18-40-4K

LED Ischia 2

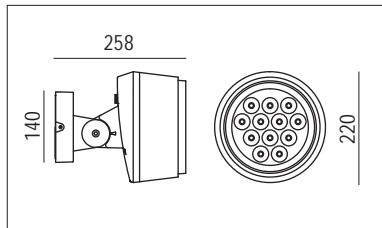

Orientabilità
inclinazione del corpo
lampada $\pm 90^\circ$
Adjustability
inclination of the lamp
body $\pm 90^\circ$

colour	W	Optic	K	Lm/W	lm Output	pcs	Kg	CELL
N	40	40°	3000	130	5200	1	3,80	215-40-40-3K
N	40	40°	2200	130	4800	1	3,80	215-40-40-2K
N	40	40°	4000	130	5200	1	3,80	215-40-40-4K

Dettaglio ottiche - Optical detail

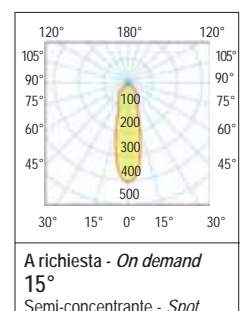
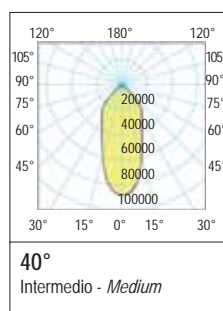
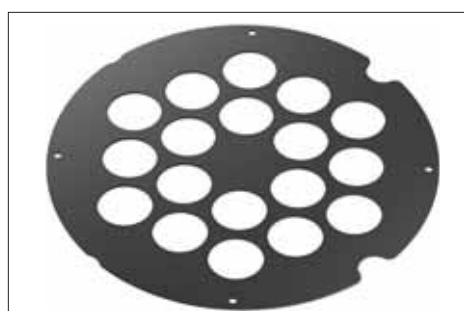





LED Ischia

Accessori non inclusi LED ISCHIA 40W - *Not included accessories LED ISCHIA 40W*



colour	Descrizione - Description	Code
N	Gancio singolo per applicazione su palo Ø 100 mm per LED Ischia 40W <i>Single Bracket for pole application Ø 100 mm LED Ischia 40W</i>	TG-215-AB
N	Gancio singolo per applicazione su palo Ø 120 mm per LED Ischia 40W <i>Single Bracket for pole application Ø 120 mm LED Ischia 40W</i>	TG-215-A
N	Gancio doppio per applicazione su palo Ø 100 mm per LED Ischia 40W <i>Double Bracket for pole application Ø 100 mm LED Ischia 40W</i>	TG-215-BA
N	Gancio doppio per applicazione su palo Ø 120 mm per LED Ischia 40W <i>Double Bracket for pole application Ø 120 mm LED Ischia 40W</i>	TG-215-B

Outdoor

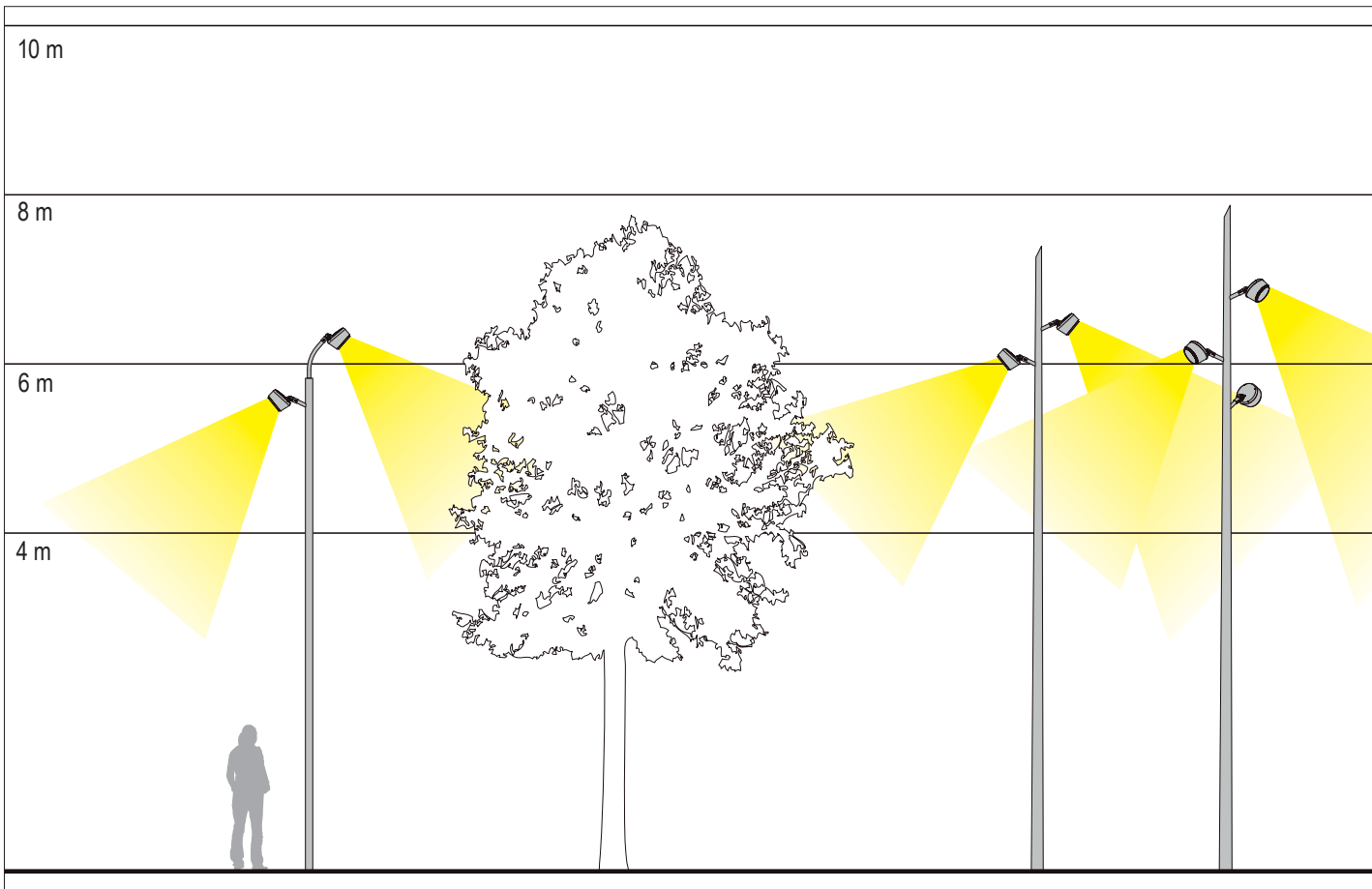

LED Ischia

Accessori non inclusi - *Not included accessories*

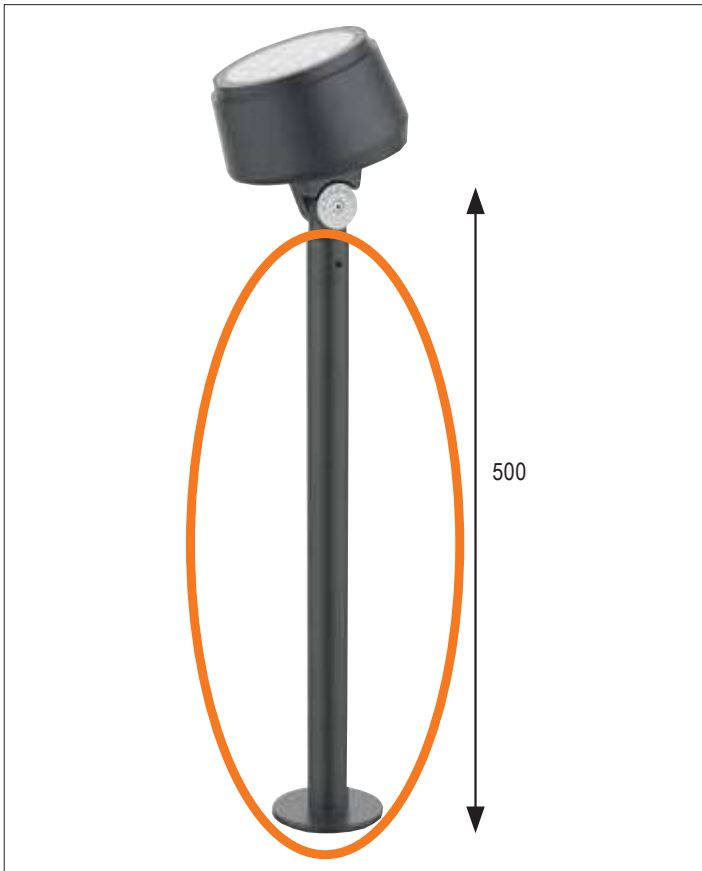

Cod. 215PA
Palo per LED Ischia - *LED Ischia pole*



Cod. 24165
Picchetto in alluminio - *Aluminium spike*

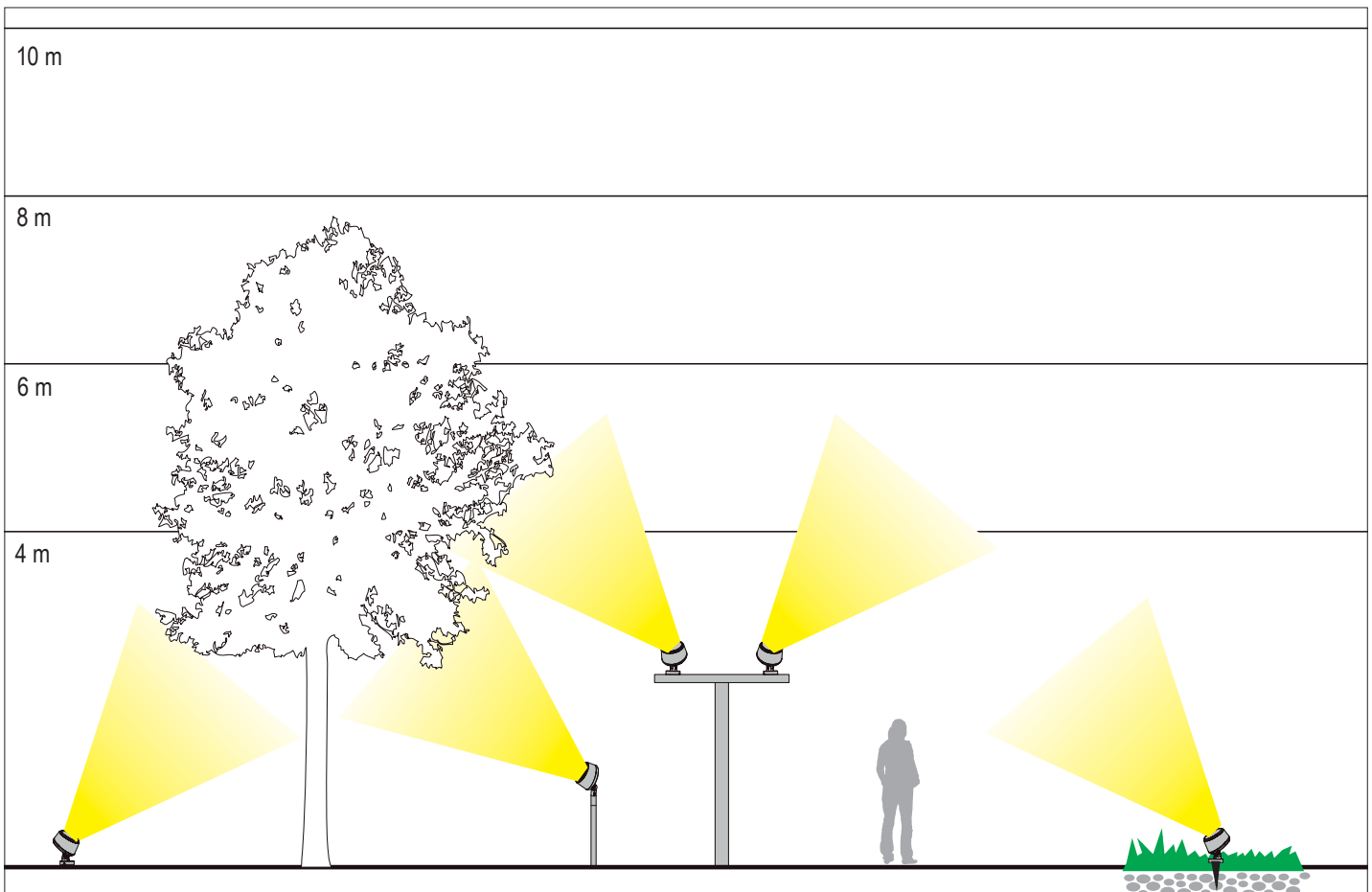

LED Nord



FAST CONNECTOR

Completo di connettore stagno maschio/femmina IP67 per il collegamento alla linea, di facile installazione.

Complete with IP67 male/female waterproof connector for connection to the line, easy to install.

Paletto per l'illuminazione di giardini e parchi, con effetto di luce discreta.

Illuminazione verso il basso a rispetto della normativa contro l'inquinamento luminoso.

Design pratico di facile installazione grazie al cavo presa e spina in dotazione il cablaggio è semplice e immediato, possibilità di scelta del palo in 3 diverse misure (da ordinare separatamente).

Installazione: a pavimento

Corpo: in alluminio pressofuso UNI EN 1706, verniciato con polvere termoindurente poliesteri

Verniciatura: di tipo poliesteri eseguita a polvere, resistente agli agenti atmosferici e alla corrosione e garantita per 1.000 ore in nebbia salina. Colore Antracite.

Diffusore: in policarbonato opalino infrangibile ed autoestinguente V2, stabilizzato ai raggi UV.

Driver: incorporato

Sorgente: LED **CREE**  Fattore di potenza $\geq 0,90$. Mantenimento del flusso luminoso al 80%. 50.000h (L80B20)

Bollard for lighting private gardens or parks, with diffused, discreet and anti-light pollution effect, with a practical design and easy to install thanks to the socket and plug cable provided. The wiring is simple and immediate and the pole comes in 3 different sizes (to be ordered separately).

Installation: floor

Body: in UNI EN 1706 die-cast aluminium, painted with thermohardening polyester powder

Painting: powder polyester coating, resistant to atmospheric agents and corrosion and guaranteed for 1,000 hours in salt spray. Colour: Anthracite.

Diffuser: in V2 self-extinguishing and shatter-proof opal polycarbonate, UV stabilised.

Driver: built-in

Source: CREE LED. Power factor ≥ 0.90 . Maintenance of 80% luminous flux. 50.000h (L80B20).

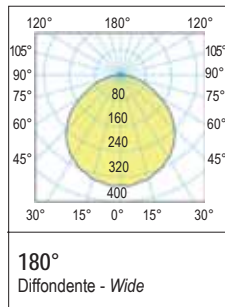
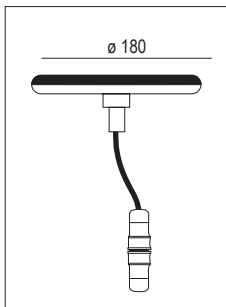

Norme di riferimento Standard reference

- EN60598-1
- EN60598-2-1
- EN62471
- EN62031
- EN60598-2-5
- EN61547

220-240
Vac

50/60
Hz

IP54

IK09

CRI
>80

+40
°C
-20

850°

DRIVER INCLUDED 

CE

colour	Ø mm	W	Optic	K	lm	pcs	Kg	CELL
A	180	10	120°	3000	720	1	0,8	25000

Outdoor



Accessori non inclusi - Not included accessories

colour	H mm	Descrizione	CELL
A	380	Palo Ø 40mm Pole Ø 40mm	25000/PAL38
A	750		25000/PAL75
A	1100		25000/PAL110

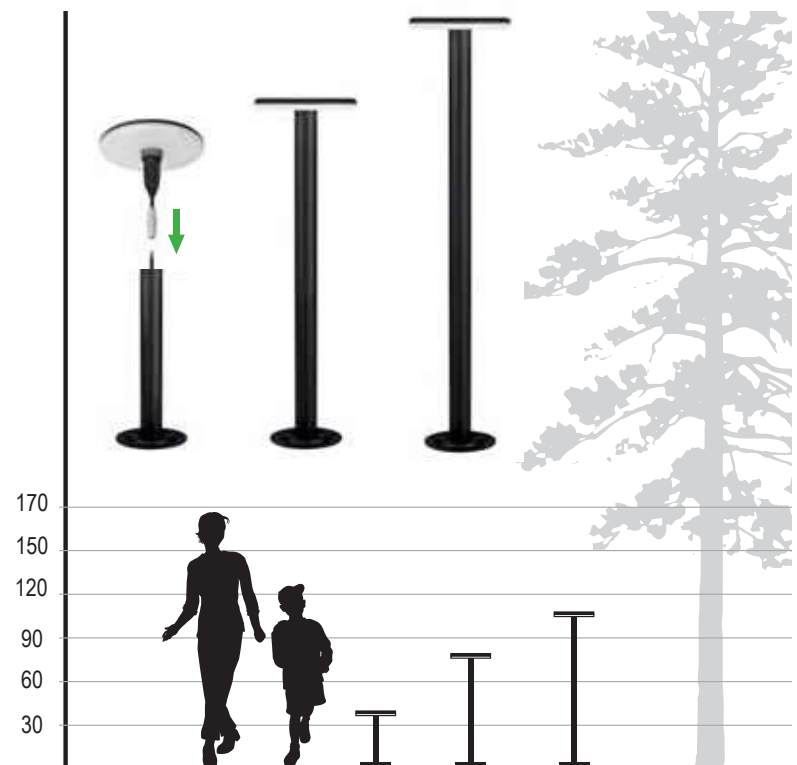
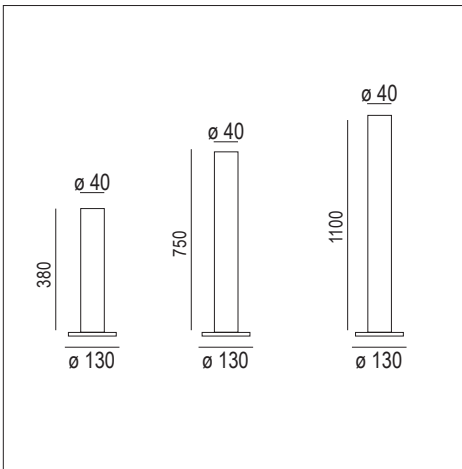

LED Ovest



Paletto per l'illuminazione di giardini o parchi, con effetto di luce discreta.

Installazione: a terra

Corpo: in alluminio pressofuso UNI EN 1706, verniciato con polvere termoidurente poliester

Verniciatura: di tipo poliester eseguita a polvere, resistente agli agenti atmosferici e alla corrosione e garantita per 1.000 ore in nebbia salina. Colore Nero RAL 9005.

Diffusore: in policarbonato trasparente

Driver: incorporato

Sorgente: LED **CREE** Fattore di potenza $\geq 0,92$. Mantenimento del flusso luminoso al 80%. 50.000h (L80B20)

Lighting bollard suitable for installation in gardens or parks, with soft effect.

Installation: on ground

Housing: made by UNI EN 1706 die-cast aluminum, coated with polyester thermoset powder

Coating: coated with powdered polyester, resistant to atmospheric agents, corrosion and guaranteed for 1.000 hours in saline mist. Black RAL9005 color.

Diffuser: made by transparent polycarbonate

Driver: included

*Light source: LED **CREE** Power factor $\geq 0,92$. maintenance of 80% minimum luminous flux: 50,000h (L80B20).*

220-240 Vac	50/60 Hz	IP65	IK09	CRI >90	+50 C° -20		850°	
DRIVER INCLUDED		CE						

colour	H mm	W	Optic	K	lm	pcs	Kg	CELL
N	500	9,7	130°	4000	600	1	2,50	24198
N	800	9,7	130°	4000	600	1	2,80	24199
N	800	25	130°	4000	1600	1	5,00	24199/PLUS
N	800	9,7	130°	3000	600	1	2,80	24199/3K
N	800	25	130°	3000	1600	1	5,00	24199/PLUS/3K

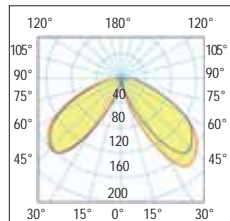

130°
Diffondente - Wide

Norme di riferimento
Standard reference
EN60598-1
EN60598-2-1
EN62471
EN62031
EN60598-2-5
EN61547

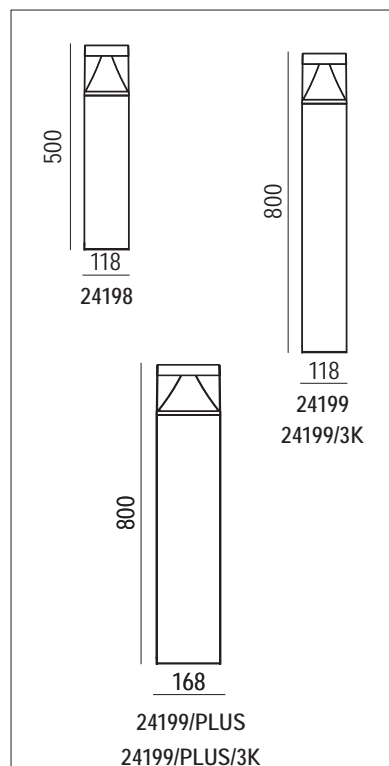



Paletto per l'illuminazione di giardini o parchi, con effetto di luce discreta.

Installazione: a terra

Corpo: in alluminio pressofuso UNI EN 1706, verniciato con polvere termoindurente poliesteri

Verniciatura: di tipo poliesteri eseguita a polvere, resistente agli agenti atmosferici e alla corrosione e garantita per 1.000 ore in nebbia salina. Colore Nero RAL 9005.

Diffusore: in policarbonato trasparente (che previene efficacemente l'ingiallimento e l'invecchiamento)

Driver: incorporato.

Sorgente: LED. Fattore di potenza $\geq 0,9$. Mantenimento del flusso luminoso al 80%. 50.000h (L80B20)

Bollard for lighting gardens or parks, with a discreet light effect.

Installation: on the ground

Body: in UNI EN 1706 die-cast aluminium, painted with polyester thermosetting powder

Painting: polyester type made with powder, resistant to atmospheric agents and corrosion and guaranteed for 1,000 hours in salt spray. Color Black RAL 9005.

Diffuser: in transparent polycarbonate (which effectively prevents yellowing and ageing)

Driver: built-in.

Source: LEDs. Power factor ≥ 0.9 . Lumen maintenance at 80%. 50.000h (L80B20)

100-240 Vac	50/60 Hz	IP66	IK09	CRI >80	+50 C -20	850°		
DRIVER INCLUDED		CE						

colour	H mm	W	Optic	K	lm	pcs	Kg	CELL
N	800	15	130°	3000	1125	1	2,80	24300



A richiesta LED Cubo può essere fornito anche in versione emergenza (aggiungere /E dopo il codice)
On request, LED Cubo can also be supplied in an emergency version (add / E after the code)

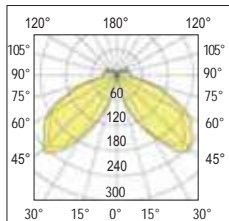

360°
Diffondente - Wide

Norme di riferimento

Standard reference

- EN60598-1
- EN60598-2-1
- EN62471
- EN62031
- EN60598-2-5
- EN61547

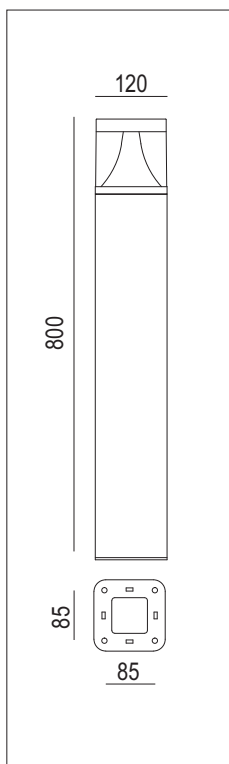

A richiesta
On demand

1-10Vdc

Pag. VI

DALI 2

Pag. VI

SENSOR

Pag. VI



Outdoor

LED Sud



Paletto per l'illuminazione di giardini o parchi, con doppia ottica idonea per l'illuminazione di camminamenti o aiuole.

Installazione: terra

Corpo: in alluminio pressofuso UNI EN 1706, verniciato con polvere termoindurente poliestere

Verniciatura: di tipo poliestere eseguita a polvere, resistente agli agenti atmosferici e alla corrosione e garantita per 1.000 ore in nebbia salina. Colore Antracite.

Diffusore: in policarbonato opalino

Portalampade: GU10

Sorgente: non inclusa, da ordinare separatamente.

Lighting bollard suitable for installation in gardens or parks, with double optics, suitable for lighting walkways or flower beds.

Installation: on ground

Housing: made by UNI EN 1706 die-cast aluminum, coated with polyester thermoset powder

Coating: coated with powdered polyester, resistant to atmospheric agents, corrosion and guaranteed for 1.000 hours in saline mist. Black RAL9005 color.

Diffuser: made by frosted polycarbonate.

Lampholder: GU10.

Light source: not included, to be ordered separately.

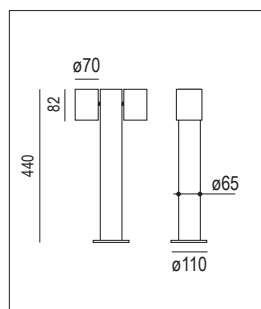
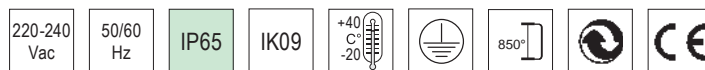

Norme di riferimento
Standard reference

EN60598-1
EN60598-2-1
EN62471
EN62031
EN60598-2-5
EN61547

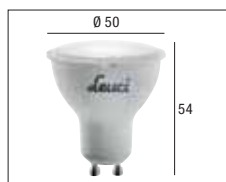

colour	H mm	W		pcs	Kg	S
N	440	max 7W	GU10	1	1,50	25001

Sorgente luminosa NON INCLUSA da ordinare a parte Light source NOT INCLUDED to be ordered separately									
W	V		K		lm	Ra			Code
6≈(40)	220-240	GU10	3000	A+	450	80	15.000	25.000	555219.0101
7≈(50)	220-240	GU10	4000	A+	700	80	15.000	25.000	55523040101

Outdoor

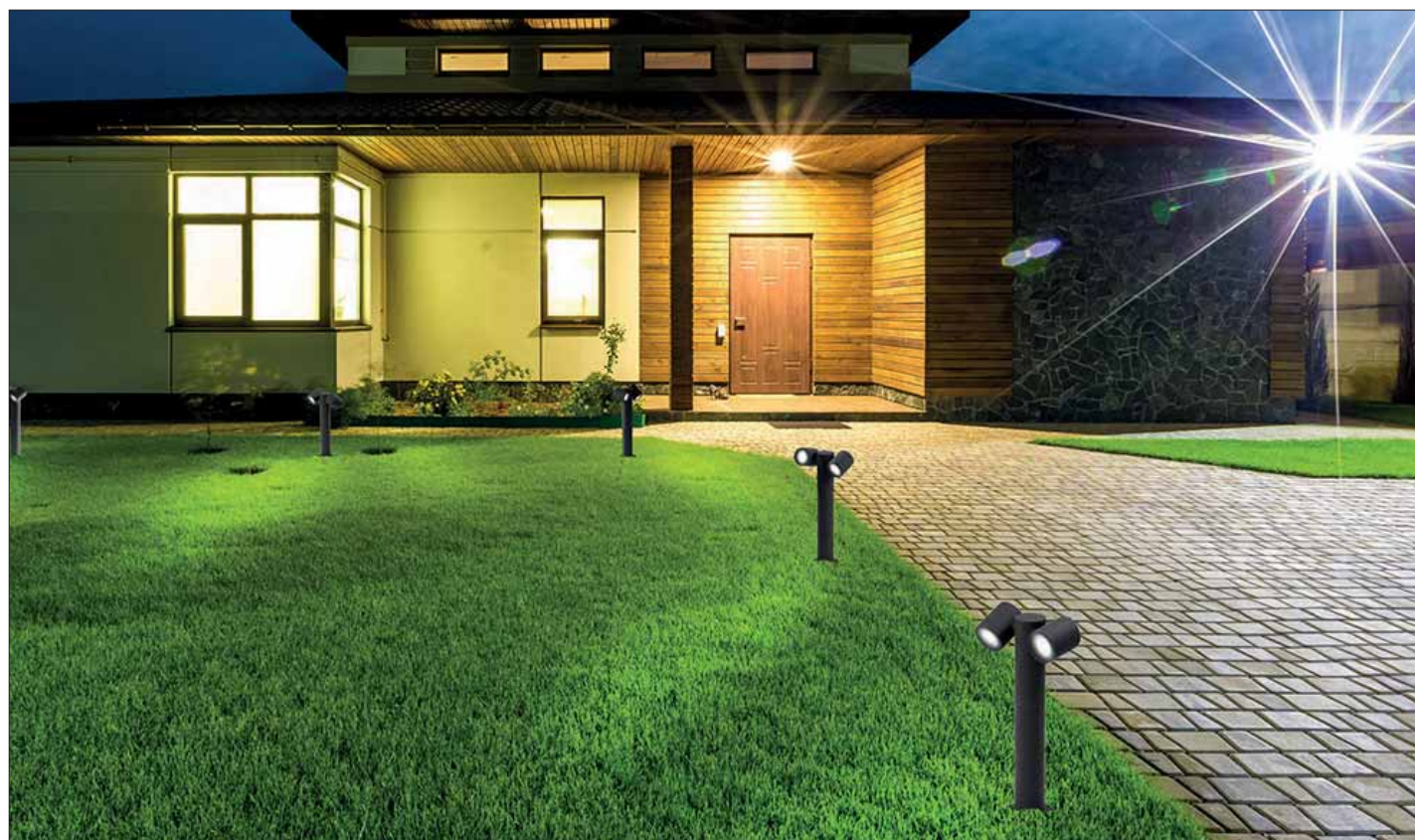

LED Sud



Rotazione ottica
Optic rotation

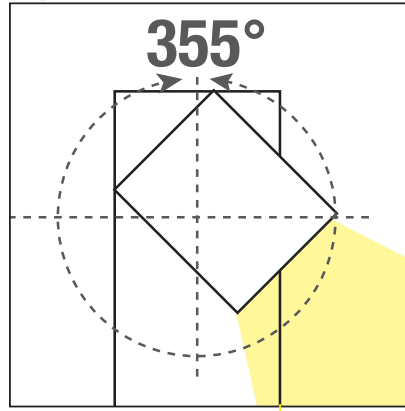

Outdoor

LED Maga



Apparecchi di illuminazione a LED installazione fissa a parete o soffitto che trovano la propria corretta applicazione dove è richiesto un punto luce con emissione con angolo flood solo verso il basso oppure verso alto e basso. L'accurata scelta dei materiali ed i trattamenti superficiali contro la corrosione eseguiti su ogni componente rendono gli apparecchi adatti a qualsiasi condizione di utilizzo in ambienti esterni.

Corpo: in lega di alluminio pressofuso verniciato e altamente resistente alla corrosione.

Verniciatura: di tipo poliesteri eseguita a polvere, resistente agli agenti atmosferici e alla corrosione e garantita per 1.000 ore in nebbia salina.

Colore: Nero RAL 9005 (LED Maga W e LED Maga C) - Bianco RAL 9003 (solo LED Maga C).

Staffa a muro: alluminio pressofuso EAN46100. Verniciatura di tipo poliesteri, eseguita a polvere

Schermo: vetro borosilicato H.4mm. extra chiaro resistente agli shock termici e agli urti
Driver: incorporato

Sorgente: LED **CREE**, mantenimento del flusso luminoso minimo al 80%: 50.000h (L80B10)

Outdoor LED lighting fixtures for fixed installation on the wall or ceiling, suitable when a light source is needed with a flood angle emission only downwards or upwards and downwards. The careful choice of materials and surface treatments against corrosion performed on each component make the fixture suitable for any outdoor environment use.

*Housing: made by UNI 5076 die-cast aluminum, coated with polyester thermoset powder
Coating: coated with powdered polyester, resistant to atmospheric agents, corrosion and guaranteed for 1.000 hours in saline mist.*

Colour: Black RAL 9005 color (LED Maga W and LED Maga C) - White RAL 9003 color (only LED Maga C).

Wall bracket: EAN46100 die-cast aluminium. Painting: powder polyester coating.

Screen: extra-light borosilicate glass resistant to thermal shocks and impacts (satin-finish upon request)

Driver: included

*Source: LED **CREE**, maintenance of 80% minimum luminous flux: 50,000h (L80B10)*

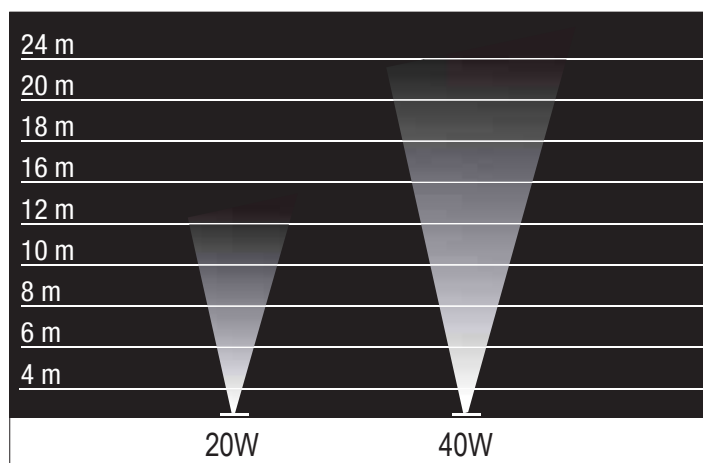
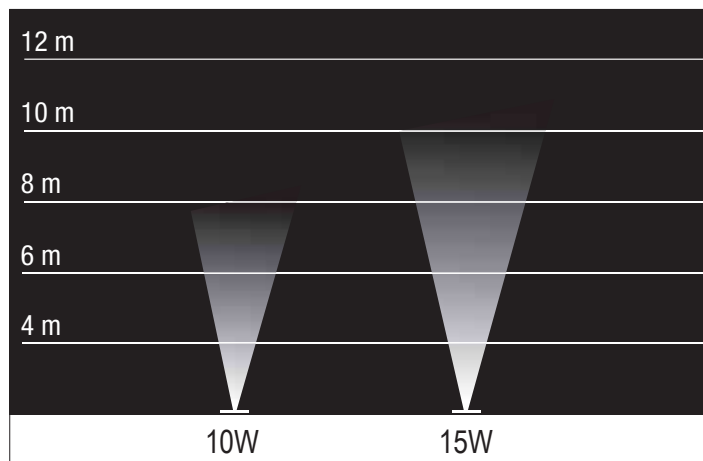

LED Maga W UP & DOWN - Ø 110mm - Ø 144mm



220-240 Vac	50/60 Hz	IP66	IK08	CRI >80	+40 C -20		850°			DRIVER INCLUDED
----------------	-------------	------	------	------------	-----------------	--	------	--	--	------------------------

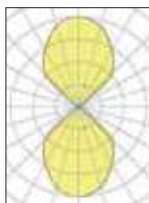

colour	W	Optic	K	lm	pcs	Kg	CELL
N	2x20	80°	4000	2x1900	1	1,40	32323
N	2x20	80°	3000	2x1900	1	1,40	32323-10
N	2x10	80°	3000	2x950	1	1,20	32323-3K

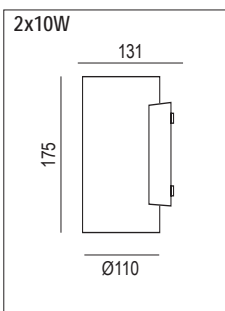
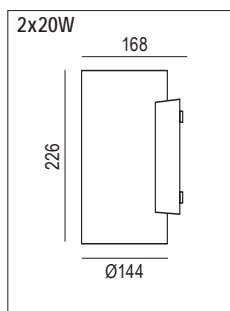

Outdoor

LED Maga W - Ø 110mm - Ø 144mm



220-240 Vac
50/60 Hz
IP66
IK08
CRI >80
+40°C / -20°C
850°
DRIVER INCLUDED

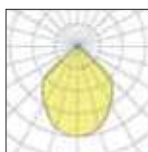

colour	W	Optic	K	lm	pcs	Kg	CELL
N	20	80°	4000	1900	1	1,40	32313
N	20	80°	3000	1900	1	1,40	32313-10
N	10	80°	3000	950	1	1,20	32313-3K

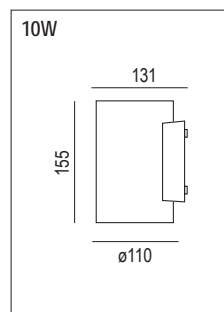
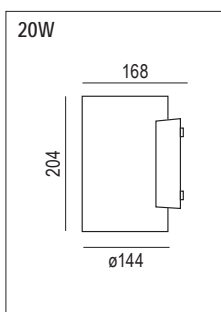

Outdoor



LED Maga C (Ø 126mm / Ø 168mm)



220-240
Vac

50/60
Hz

IP66

IK08

CRI
>80

+40
C
-20



850°



DRIVER INCLUDED

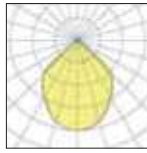

colour	W	Optic	K	lm	pcs	Kg	CELL
N	15	100°	4000	1425	1	1,10	32299
N	15	100°	3000	1425	1	1,10	32299/3K
B	15	100°	3000	1425	1	1,10	32299/3K/WH
N	40	100°	4000	3800	1	1,10	32322
N	40	100°	3000	3800	1	1,10	32322/3K

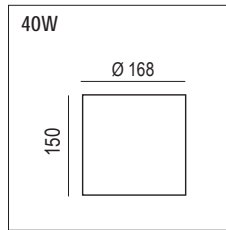
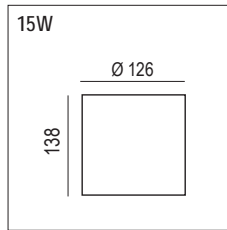

Outdoor



LED Asso Round

NEW 2023

LED Asso Round è un'applicazione a LED dal design cilindrico.

Corpo: il corpo è in alluminio e impermeabile

Diffusore: policarbonato satinato con rivestimento UV, resistente ai raggi UV.

Verniciatura: di tipo poliestere eseguita a polvere, resistente agli agenti atmosferici e alla corrosione e garantita per 1.000 ore in nebbia salina.

Colore Nero RAL 9005 o bianco RAL9016

L'angolo del fascio di 360 gradi può fornire prestazioni di illuminazione brillanti.

Solo la direzione della luce verso l'alto e la direzione della luce verso l'alto e verso il basso per l'opzione. È materiale

Dimmerabile con dimmer TRIAC.

Nome di riferimento: EN60598-1; EN60598-2-1; EN62471; EN62031; EN60598-2-5; EN61547

LED Asso Round is a cylindrical design LED wall light.

Body: The body is made of aluminum and waterproof

Diffuser: UV coated satin polycarbonate, UV resistant.

Painting: polyester powder type, resistant to atmospheric agents and corrosion and guaranteed for 1,000 hours in saline mist.

Color Black RAL 9005 or white RAL9016

The 360 degree beam angle can provide brilliant lighting performance.

Only the direction of the light upwards and the direction of the light upwards and downwards for the option. It is material

Dimmable with TRIAC dimmer.

Reference number: EN60598-1; EN60598-2-1; EN62471; EN62031; EN60598-2-5; EN61547

LED Asso Round



220-240 Vac	50/60 Hz	IP65	IK08	CRI >80	+40°C -20°C	750°	750°	750°	750°	750°	750°	DRIVER INCLUDED
-------------	----------	------	------	---------	----------------	------	------	------	------	------	------	-----------------



colour	W	Optic	K			lm	pcs	Kg	CELL
N	8	170°	3000	4000	5700	670	1	0,90	RL28C76BL8WP3
B	8	170°	3000	4000	5700	670	1	0,90	RL28C76WH8WP3

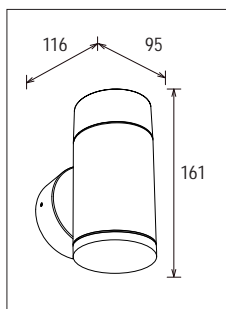

Funzione 3 CCT (3000K - 4000K - 5700K) modificabile con interruttore a cursore

Slide switch 3 CCT (3000K - 4000K - 5700K) changeable function

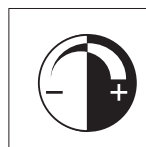

Regolabile con dimmer a TRIAC
Dimmable with TRIAC dimmer

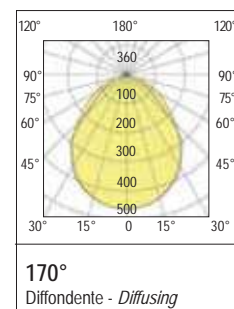

LED Asso Round Up & Down



220-240 Vac	50/60 Hz	IP65	IK08	CRI >80	+40°C -20°C	750°	750°	750°	750°	750°	750°	DRIVER INCLUDED
-------------	----------	------	------	---------	----------------	------	------	------	------	------	------	-----------------



colour	W	Optic	K			lm	pcs	Kg	CELL
N	2x4	170°	3000	4000	5700	670	1	0,90	RL28B76BL8WP3
B	2x4	170°	3000	4000	5700	670	1	0,90	RL28B76WH8WP3

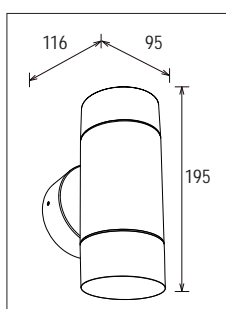

Funzione 3 CCT (3000K - 4000K - 5700K) modificabile con interruttore a cursore

Slide switch 3 CCT (3000K - 4000K - 5700K) changeable function



Regolabile con dimmer a TRIAC
Dimmable with TRIAC dimmer

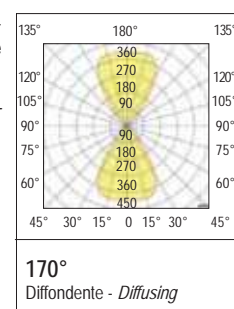

Outdoor



LED Asso Square Down - LED Asso Square Up & Down

NEW 2023

Appliche ideale per illuminare ingressi o facciate e elementi architettonici.

Installazione: soffitto o parete

Corpo e telaio: in alluminio pressofuso UNI EN 1706 verniciato con polvere termoisolante poliesteri

Diffusore: policarbonato satinato con rivestimento UV, resistente ai raggi UV.

Verniciatura: di tipo poliesteri eseguita a polvere, resistente agli agenti atmosferici e alla corrosione e garantita per 1.000 ore in nebbia salina.

Colore Nero RAL 9005 o bianco RAL9016

Driver: incorporato

Sorgente: LED SMD

Doppio ingresso Loop In/Out e terminale rapido per una rapida installazione

CCT intercambiabile (3000K + 4000K + 5700K) con interruttore a scorrimento

Ideal wall lamp to illuminate entrances or facades and architectural elements.

Installation: ceiling or wall

Body and frame: die-cast aluminum UNI EN 1706 painted with polyester thermosetting powder

Diffuser: UV coated satin polycarbonate, UV resistant.

Painting: polyester powder type, resistant to atmospheric agents and corrosion and guaranteed for 1,000 hours in saline mist.

Color Black RAL 9005 or white RAL9016

Driver: built-in

Source: LED SMD

Double Loop In / Out input and quick terminal for quick installation

Interchangeable CCT (3000K + 4000K + 5700K) with slide switch

LED Asso square



220-240 Vac	50/60 Hz	IP65	IK08	CRI >80	+45°C -20°C	750°	DRIVER INCLUDED	CE
-------------	----------	------	------	---------	----------------	------	-----------------	----

3in1

colour	W	Optic	Lm	K			pcs	Kg	CELL
N	4	120°	450	3000	4000	5700	1	0,64	RL113BL4WP3
B	4	120°	450	3000	4000	5700	1	0,64	RL113WH4WP3

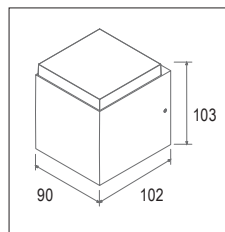

Funzione 3 CCT (3000K - 4000K - 5700K) modificabile con interruttore a cursore
Slide switch 3 CCT (3000K - 4000K - 5700K) changeable function



Outdoor

LED Asso square Up & Down

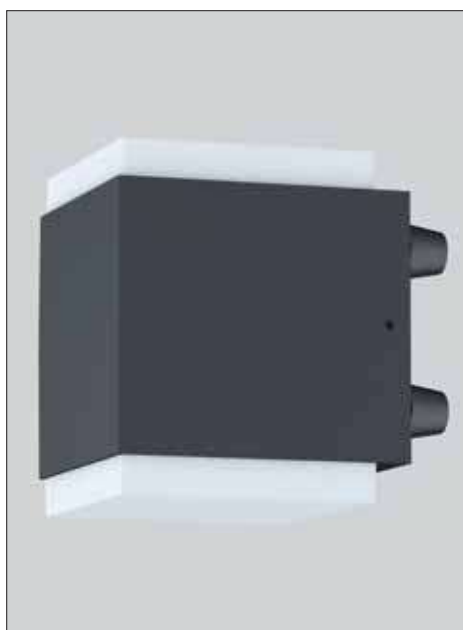

220-240 Vac	50/60 Hz	IP65	IK08	CRI >80	+45°C -20°C	750°	DRIVER INCLUDED	CE
-------------	----------	------	------	---------	----------------	------	-----------------	----

3in1

colour	W	Optic	Lm	K			pcs	Kg	CELL
N	2x4	120°	900	3000	4000	5700	1	0,56	RL113CBL4WP3
B	2x4	120°	900	3000	4000	5700	1	0,56	RL113CWH4WP3

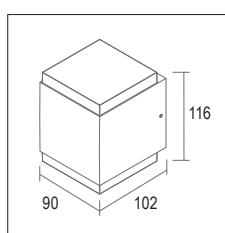

Funzione 3 CCT (3000K - 4000K - 5700K) modificabile con interruttore a cursore
Slide switch 3 CCT (3000K - 4000K - 5700K) changeable function



LED Su & Giù



Appliche ideale per illuminare ingressi o facciate e elementi architettonici.

Installazione: a parete

Corpo e telaio: in alluminio pressofuso UNI EN 1706 verniciato con polvere termoidurente poliestere

Verniciatura: di tipo poliestere eseguita a polvere, resistente agli agenti atmosferici e alla corrosione e garantita per 1.000 ore in nebbia salina. Colore Nero RAL 9005 o bianco RAL9003

Ottica: regolabile solo per il modello Su & Giù. Per il modello Doppio Su & Giù l'ottica non è regolabile

Driver: incorporato

Sorgente: LED **CREE** manutenzione del flusso luminoso minimo al 80%: 50.000h (L80B10).

Wall luminaire made by die-cast aluminum perfect to light up facades and architectural elements.

Installation: wall use

Housing and frame: made by UNI EN 1706 die-cast aluminum, coated with polyester thermoset powder

Coating: coated with powdered polyester, resistant to atmospheric agents, corrosion and guaranteed for 1.000 hours in saline mist. Black RAL9005 or RAL 9003 white color

Optic: adjustable only for the Up & Down model. For the Double Up & Down model, the optics are not adjustable

Driver: included

*Light source: LED **CREE** maintenance of 80% minimum luminous flux: 50,000h (L80B10).*



colour	W	K	lm	pcs	Kg	CELL
N	9	3000	750	1	1,00	32292
B	9	3000	750	1	1,00	32291

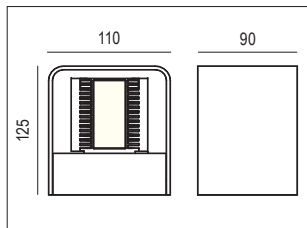

Norme di riferimento
Standard reference
EN60598-1
EN60598-2-1
EN62471
EN62031
EN60598-2-5
EN61547

Outdoor

Alette orientabili per l'emissione della luce con diverse inclinazioni - Adjustable fins to allow the emission of light with different inclinations



LED Doppio Su & Giù

NEW 2023

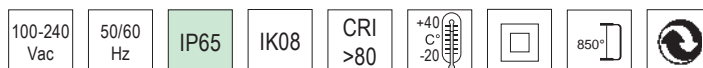

colour	W	K	lm	pcs	Kg	CELL
N	18	3000	1500	1	1,50	32292-2

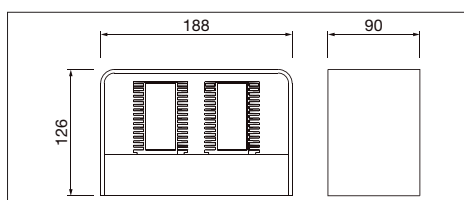





LED Micro Solo Giù Round - LED Medio Solo Giù Square

NEW 2023

Plafoniera a LED idonea per applicazioni civili per l'illuminazione di camminamenti residenziali, spazi commerciali o alberghieri.

Le linee quadrate e circolari semplici combinate con la sorgente di luce a LED indiretta possono creare un ambiente di illuminazione bello e morbido.

L'applicazione può essere utilizzata sia in ambienti interni che esterni.

Corpo: realizzato in lega di alluminio ad alta resistenza e resistente ai raggi UV.

Diffusore: in vetro temprato 4mm

Colore: Nero RAL9005 o Bianco RAL9016

Installazione: a parete

Verniciatura: di tipo poliestere eseguita a polvere, resistente agli agenti atmosferici e alla corrosione

Norme di riferimento: EN60598-1; EN60598-2-1; EN62471; EN62031; EN60598-2-5; EN61547

LED ceiling light suitable for civil applications for

the lighting of residential walkways, commercial or hotel spaces.

Simple square and circular lines combined with indirect LED light source can create a beautiful and soft lighting environment.

The wall lamp can be used both indoors and outdoors.

Body: made of high strength and UV resistant aluminum alloy.

Diffuser: in 4mm tempered glass

Color: Black RAL9005 or White RAL9016

Installation: on the wall

Painting: polyester powder type, resistant to atmospheric agents and corrosion

Reference number: EN60598-1; EN60598-2-1; EN62471; EN62031; EN60598-2-5; EN61547

LED Micro Solo Giù Round



200-240 Vac	50/60 Hz	IP65	IK08	CRI >80	+45 C° -20	750°	DRIVER INCLUDED	CE	
colour	W	Optic	K	lm	pcs	Kg	CELL		
N	5	60°	3000	170	1	0,33	RLRO59A5W3KBL		
B	5	60°	3000	170	1	0,33	RLRO59A5W3KWH		

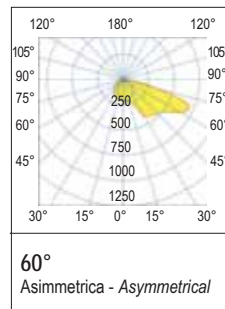
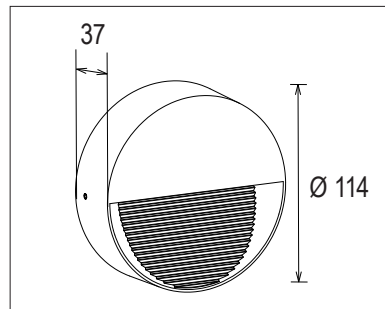

Outdoor

LED Medio Solo Giù Square



200-240 Vac	50/60 Hz	IP65	IK08	CRI >80	+45 C° -20	750°	DRIVER INCLUDED	CE	
colour	W	Optic	K	lm	pcs	Kg	CELL		
N	5	60°	3000	170	1	0,39	RLSQ59A5W3KBL		
B	5	60°	3000	170	1	0,39	RLSQ59A5W3KWH		

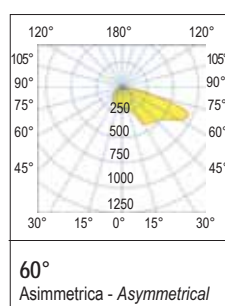
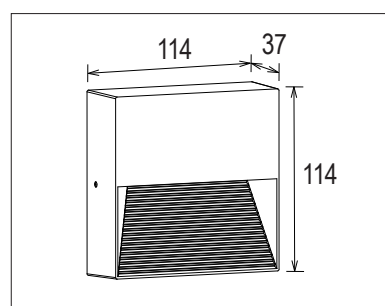

LED Sologiu R - LED Sologiu S

Plafoniera a LED idonea per applicazioni civili per l'illuminazione di camminamenti residenziali, spazi commerciali o alberghieri.

Installazione: a parete

Corpo: in alluminio pressofuso UNI EN 1706, verniciato con polvere termoindurente poliesteri

Verniciatura: di tipo poliesteri eseguita a polvere, resistente agli agenti atmosferici e alla corrosione e garantita per 1.000 ore in nebbia salina. Colore Antracite RAL7024.

Diffusore: in vetro temperato piano extrachiaro.

Cablaggio: con doppio ingresso cavi.

Sorgente: LED **SAMSUNG** mantenimento del flusso luminoso minimo al 80%: 50.000h (L80B10).

LED ceiling light suitable for civil applications for the lighting of residential walkways, commercial or hotel spaces.

Installation: wall mounting

Housing: made by UNI EN 1706 die-cast aluminum, coated with polyester thermoset powder

Coating: coated with powdered polyester, resistant to atmospheric agents, corrosion and guaranteed for 1.000 hours in saline mist. Anthracite color RAL7024.

Diffuser: in extra-clear flat tempered glass.

Wiring: with double cable entry.

Light source: LED **SAMSUNG** maintenance of 80% minimum luminous flux: 50,000h (L80B10).

220-240 Vac	50/60 Hz	IP65	IK06	+40 C° -20		850°		CE	DRIVER INCLUDED 	
----------------	-------------	------	------	------------------	--	------	--	----	---------------------	--

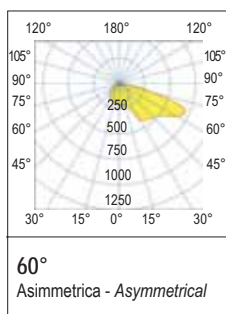
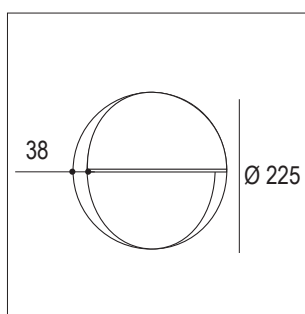

LED Sologiu R							
colour	W	Optic	K	lm	pcs	Kg	CELL
A	8,5	60°	3000	300	1	0,8	SOLOGIUR

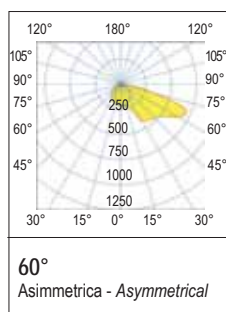
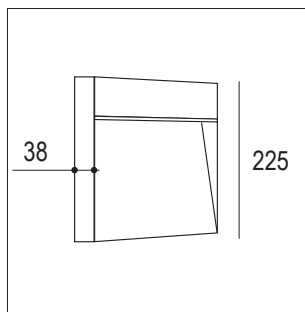

LED Sologiu S							
colour	W	Optic	K	lm	pcs	Kg	CELL
A	8,5	60°	3000	300	1	0,8	SOLOGIUS



Outdoor

La lampada da parete LED Mole è un design di illuminazione up & down

Corpo: in alluminio pressofuso per un'eccellente dissipazione termica. la superficie della lampada è spruzzata con polvere di granelli di sabbia per esterni, resistente alla corrosione

Diffusore: in vetro temprato 4mm

Verniciatura: Nero RAL 9005 o Bianco RAL 9016 (anti corrosione e resistente agli agenti atmosferici)

Sorgente: LED SMD

Installazione: a parete sia per interno che per esterno

Alimentazione: inclusa

Il design della struttura robusta, l'impermeabilità IP65 si adatta a un'area di applicazione più ampia.

The Mole LED wall lamp is an up & down lighting design

***Body:** in die-cast aluminum for excellent heat dissipation. The surface of the lamp is sprayed with outdoor sand grain powder, corrosion resistant*

***Source:** SMD LED*

***Diffuser:** in 4mm tempered glass*

***Paint:** Black RAL 9005 or White RAL 9016 (corrosion and weather resistant)*

***Installation:** one wall for both indoor and outdoor*

***Power supply:** included*

Rugged structure design, IP65 waterproofing suits larger application area.



220-240 Vac	50/60 Hz	IP65	IK07	+45 C° -20		750°	
----------------	-------------	------	------	------------------	--	------	--

CE **DRIVER INCLUDED** **3 in 1**

colour	W	Optic	Lm	K			pcs	Kg	CELL
N	10	180°	700	3000	4000	5700	1	0,71	RL88-10W-BL3P
B	10	180°	700	3000	4000	5700	1	0,71	RL88-10W-WH3P

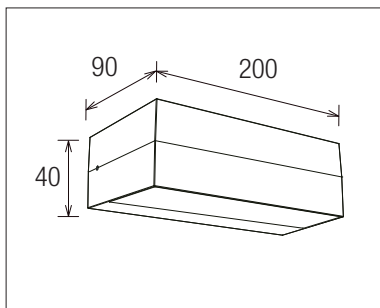

Funzione 3 CCT (3000K - 4000K - 5700K)
modificabile con interruttore a cursore
*Slide switch 3 CCT (3000K - 4000K - 5700K)
changeable function*



Regolabile con dimmer a TRIAC
Dimmable with TRIAC dimmer



Outdoor



LED Up & Down

A richiesta
On demand



NEW 2023

Plafoniera a LED idonea per applicazioni civili per l'illuminazione di camminamenti residenziali, spazi commerciali o alberghieri.

Per utilizzo in indoor e outdoor.

Installazione: a parete

Corpo: realizzato in alluminio pressofuso.

Vetro: temperato opalino, ad elevato comfort visivo e distribuzione luminosa uniforme.

Verniciatura: di tipo poliestere eseguita a polvere, resistente agli agenti atmosferici e alla corrosione e garantita per 1.000 ore in nebbia salina. Colore Nero RAL 9005

Driver: incorporato

Nessun rischio fotobiologico, secondo EN 62471:2008.

La massima temperatura superficiale di tutte le parti accessibili sotto i 50 gradi per sicurezza e affidabilità.

Sorgente: LED. Mantenimento del flusso luminoso minimo al 80%: 50.000h (L80B10)

LED ceiling light suitable for civil applications for lighting residential walkways, commercial spaces or hotels..

The applique can be used both indoors and outdoors.

Installation: on the wall

Body: made of die-cast aluminium.

Glass: opal tempered, with high visual comfort and uniform light distribution.

Painting: polyester type made with powder, resistant to atmospheric agents and corrosion and guaranteed for 1,000 hours in salt spray. Color Black RAL 9005

Drivers: included

No photobiological risk, according to EN 62471:2008.

Maximum surface temperature of all accessible parts below 50 degrees for safety and reliability.

Source: LEDs. Minimum luminous flux maintenance at 80%: 50,000h (L80B10)



220-240 Vac	50/60 Hz	IP65	IK08	+45 C° -20		750°	
----------------	-------------	------	------	------------------	--	------	--



colour	W	Optic	Lm	K	pcs	Kg	CELL
N	30	100°	4500	3000	1	1,00	SUGIU363K
N	30	100°	4500	4000	1	1,00	SUGIU364K

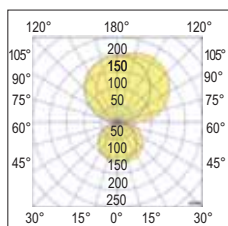
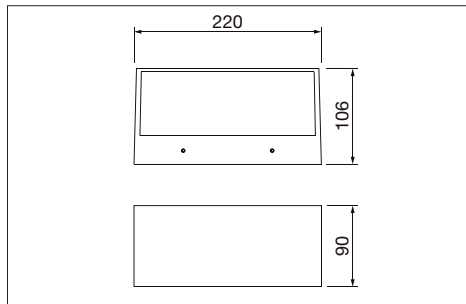

100°
Diffondente - Wide

Norme di riferimento
Standard reference

- EN60598-1
- EN60598-2-1
- EN62471
- EN62031
- EN60598-2-5
- EN61547



Outdoor

LED Lodi Giù

Outdoor

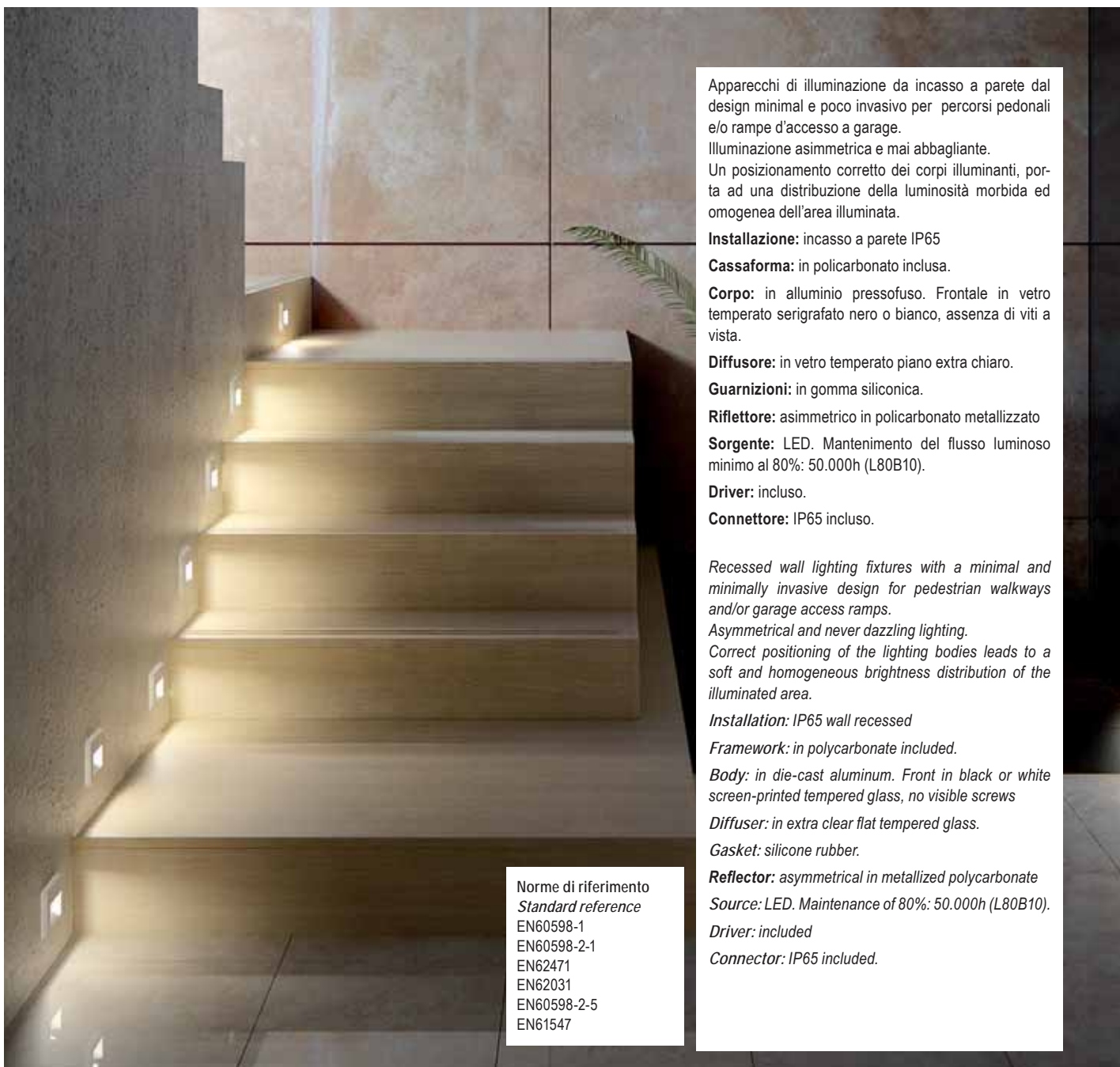

Norme di riferimento
Standard reference
EN60598-1
EN60598-2-1
EN62471
EN62031
EN60598-2-5
EN61547

Apparecchi di illuminazione da incasso a parete dal design minimal e poco invasivo per percorsi pedonali e/o rampe d'accesso a garage.

Illuminazione asimmetrica e mai abbagliante.

Un posizionamento corretto dei corpi illuminanti, porta ad una distribuzione della luminosità morbida ed omogenea dell'area illuminata.

Installazione: incasso a parete IP65

Cassaforma: in policarbonato inclusa.

Corpo: in alluminio pressofuso. Frontale in vetro temperato serigrafato nero o bianco, assenza di viti a vista.

Diffusore: in vetro temperato piano extra chiaro.

Guarnizioni: in gomma siliconica.

Riflettore: asimmetrico in policarbonato metallizzato

Sorgente: LED. Mantenimento del flusso luminoso minimo al 80%: 50.000h (L80B10).

Driver: incluso.

Connettore: IP65 incluso.

Recessed wall lighting fixtures with a minimal and minimally invasive design for pedestrian walkways and/or garage access ramps.

Asymmetrical and never dazzling lighting.

Correct positioning of the lighting bodies leads to a soft and homogeneous brightness distribution of the illuminated area.

Installation: IP65 wall recessed

Framework: in polycarbonate included.

Body: in die-cast aluminum. Front in black or white screen-printed tempered glass, no visible screws

Diffuser: in extra clear flat tempered glass.

Gasket: silicone rubber.

Reflector: asymmetrical in metallized polycarbonate

Source: LED. Maintenance of 80%: 50.000h (L80B10).

Driver: included

Connector: IP65 included.



LED Lodi Giù

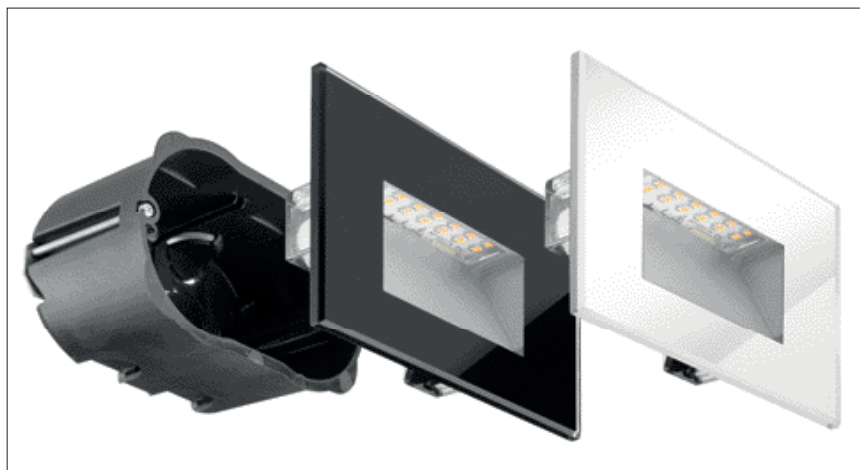

220-240 Vac	110 Vac a richiesta on demand	50/60 Hz	IP65	IK06	CE
	85°		CRI >80	+40 C -20	



colour	W	Optic	K	lm	pcs	Kg	CELL
N	1,5	ASY	3000	70	1	0,7	29091
B	1,5	ASY	3000	70	1	0,7	29090
N	2,5	ASY	3000	130	1	0,7	29093
B	2,5	ASY	3000	130	1	0,7	29092
N	3,5	ASY	3000	190	1	0,7	29095
B	3,5	ASY	3000	190	1	0,7	29094

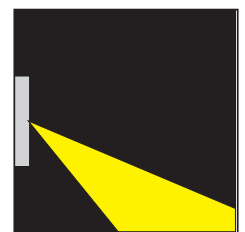
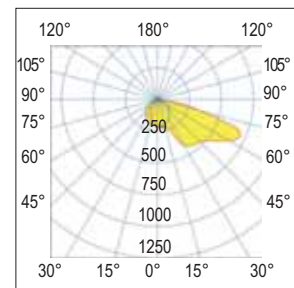
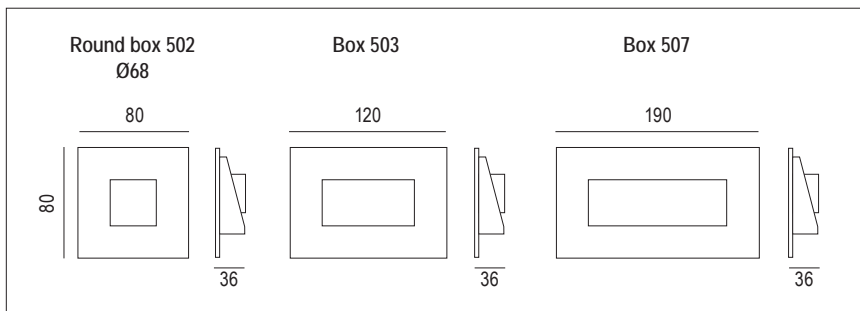

ASY
Asimmetrica - Asymmetrical



Outdoor

Accessori NON inclusi - NOT included accessories

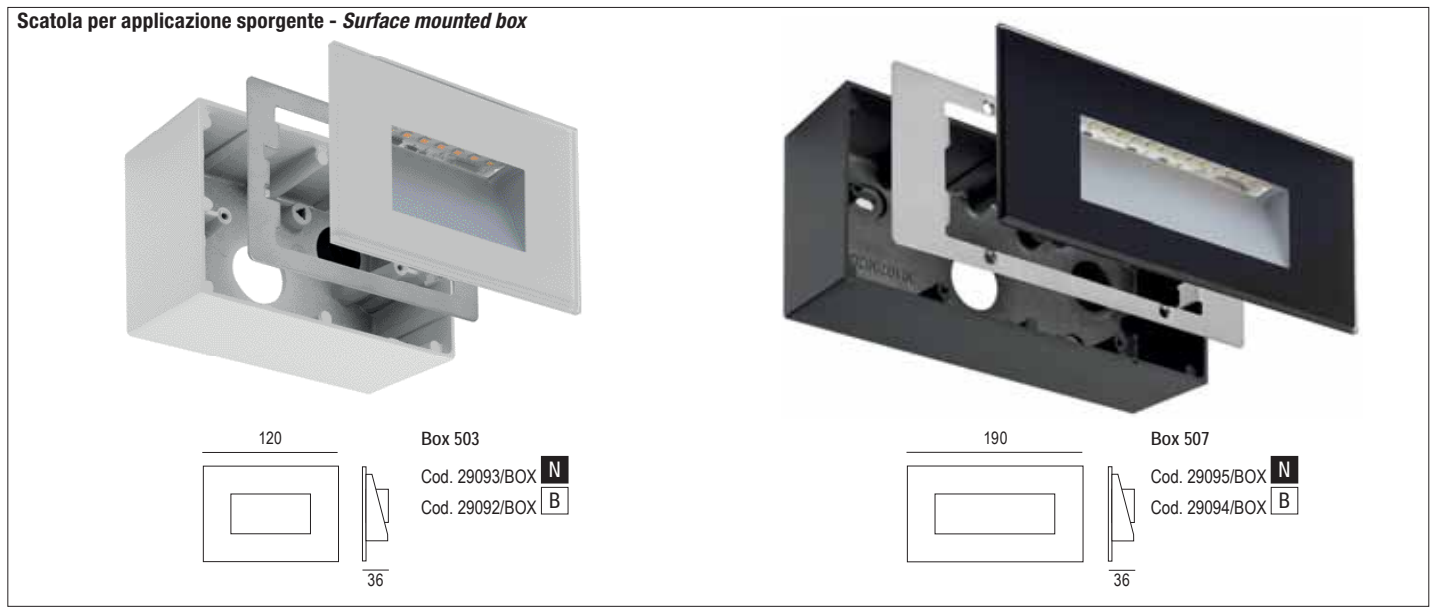

LED Turbot

NEW 2023

L'applicazione LED Turbot ha un design su e giù con driver interno

Corpo: in alluminio pressofuso per un'eccellente dissipazione termica

Verniciatura: Nero RAL 9005 o Bianco RAL 9016 (anti corrosione e resistente agli agenti atmosferici)

Diffusore: policarbonato con rivestimento UV, resistente ai raggi UV.

Installazione: a plafone o parete sia per interno che per esterno

Alimentazione: inclusa

Turbot LED wall light has an up and down design with internal driver

Body: in die-cast aluminum for excellent heat dissipation

Paint: Black RAL 9005 or White RAL 9016 (corrosion and weather resistant)

Diffuser: UV coated polycarbonate, UV resistant.

Installation: surface or wall mounted for both indoor and outdoor

Power supply: included



100-240 Vac	50/60 Hz	IP65	IK10	+45 C° -20	
750°		CE	DRIVER INCLUDED		

colour	W	Optic	K	Lm	pcs	Kg	CELL
N	8	180°	3000	600	1	0,42	RL08-8W-BL3K
B	8	180°	3000	600	1	0,42	RL08-8W-WH3K

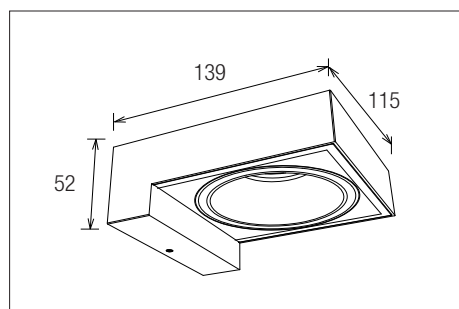

Outdoor



LED Line Up

Illuminazione che disegna l'architettura con fasci di luce mettendo in evidenza vuoti e pieni che ne enfatizzano la tridimensionalità degli spazi.

La luce interagendo con la materia crea ambienti nuovi che di giorno non esistono

Il corpo illuminante tende a scomparire per le sue ridotte dimensioni

Installazione: parete o soffitto

Corpo e telaio: schermo in polimetacrilato, corpo in alluminio pressofuso

Driver: incluso

Light designs architecture with beams of light highlighting empty and full that emphasize the three-dimensionality of spaces.

Light interacting with matter creates new rooms that do not exist during the day

The lighting body tends to disappear thanks to its small sizes

Installation: Wall and ceiling mounted

Body and frame: polymerised acrylic screen, die-cast aluminum body

Driver: driver included



220-240 Vac	50/60 Hz	IP55	IK08	CRI >80	+45 C° -20	
----------------	-------------	------	------	------------	------------------	--

750°		CE	DRIVER INCLUDED 	
------	--	----	---------------------	--

colour	W	Optic	K	lm output	pcs	Kg	CELL
N	6	180°	4000	118	1	0,30	29140
N	6	180°	3000	118	1	0,30	29141

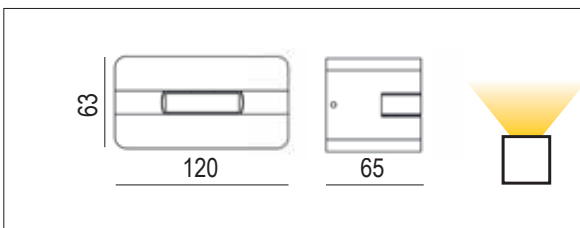

Outdoor

LED Platax BASIC - PLUS - XL



Outdoor

LED Platax BASIC - LED Platax PLUS - LED Platax XL

Plafoniera a LED stagna, idonea per applicazioni civili, commerciali, alberghiere.

Corpo e cornice: in nylon rinforzato con fibre di vetro, guarnizione in silicone, viti Torx anti-vandalo imperdibili.

Diffusore: in policarbonato opale, antiurto ed autoestinguente.

Cablaggio: composto da alimentazione 220-240V 50Hz, cavi in PVC HT 105° non propagante la fiamma, doppio isolamento. LED Platax è installabile sia per impianto sotto parete che esterno; fornita di serie con pressacavo in nylon PG13,5.

LED Platax Eye - LED Platax Eye Plus - Con sensore di movimento

Plafoniera a LED con sensore ad alta frequenza a 5,8 GHz. Colorazione neutra e gradevole, intensità e tonalità della luce invariate nel tempo. Sensore invisibile estremamente sensibile e silenzioso nell'accensione, con risposta immediata. È possibile regolare la sensibilità di rilevamento, la distanza di intervento, la soglia di luminosità ed il tempo di accensione.

Caratteristiche tecniche EMERGENZA

Plafoniera Stagna LED con Emergenza integrata.

LED Platax utilizza 21+21 LED (21 LED emergenza).

Il Gruppo di Emergenza interviene automaticamente in caso di interruzione della rete elettrica.

- Flusso luminoso costante in emergenza.
- Spegnimento automatico per sottotensione di batteria.
- Batteria a 3 elementi 3,6 V, 4 A/h.
- Tempo di ricarica massimo 24 ore
- Autonomia 3h, con flusso al 15%.
- Spia LED di attivazione del circuito di ricarica.

Sorgente: LED

Mantenimento del flusso luminoso minimo al 80% - 80.000h (L80B20).

- **Accensioni separate (2 drivers all'interno all'interno per codice 555616.0101).**

Norme di riferimento: EN60598-1, EN60598.2.1, EN62471, EN62031.

Nessun rischio fotobiologico, RG0 gruppo di rischio esente (EN62471).

Grado IP: IP65 certificato da laboratorio accreditato

Prodotto conforme alle direttive:

LED Platax - LED Platax Plus - LED Platax XL

Compact waterproof LED fitting suitable for civil, commercial, hotel applications, etc.

Body and frame: made by nylon reinforced with glass fibres, silicone gasket, non-loosening Torx screws.

Diffuser: made by shockproof and self-extinguishing opal polycarbonate.

Wiring: includes 220-240V 50Hz control gear, non-flame propagating PVC HT 105° cables, double insulated. LED Platax can be installed in both concealed and outdoor circuits; supplied with nylon cable gland RG13,5.

LED Platax Eye - LED Platax Eyr Plus - with motion sensor

Fitting with 5.8 GHz high-frequency sensor with neutral and pleasant colour, unaltered light intensity over time, extremely sensitive invisible sensor and silent switching-on, with instant response. The detection sensitivity, intervention distance, luminosity threshold and lighting time can be adjusted.

Emergency Technical features

Water Proof LED fitting with integrated Emergency Kit integrated.

LED Platax uses 21+21 LED (21 LED emergency).

Emergency Kit turns on when power is cut.

- Non stop light flow during emergency.
- Under voltage lockout.
- Battery with 3 elements 3,6V, 4 A/h included.
- Charging time max 24 hours.
- Autonomy 3h with flux 15%.
- LED Monitor to indicate mains-on conditions.

Source: LED

Maintenance of minimum luminous flux to 80% - 80.000h (L80B20).

- **Double switching (2 drivers inside only for 555616.0101 code)**

Reference standards: EN60598-1, EN60598.2.1, EN62471, EN62031.

No risk of photobiological damage, RG0 group (EN62471).

IP degre: IP65 certified by an external laboratory

In compliance with the directives:

Accessori - Accessories

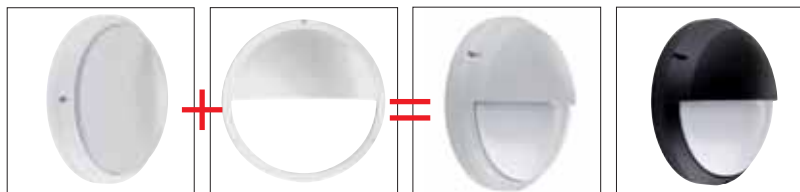

B Cod. CO3001.100 - Ø 290mm (Platax Basic - Platax plus multipower) Visiera Nylon - Nylon visor

N Cod. CO3002.100 - Ø 290mm (Platax Basic - Platax plus multipower) Visiera Nylon - Nylon visor

B Cod. CO4001.100 - Ø 376mm (Platax XL) Visiera Nylon - Nylon visor

N Cod. CO4002.100 - Ø 376mm (Platax XL) Visiera Nylon - Nylon visor

Dati fotometrici - Photometric data

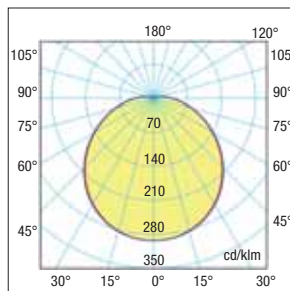

LED Platax BASIC

220-240V 50/60Hz



IK09

IP65

Led Platax BASIC



A richiesta: dimmerabile
On demand: dimmable

DRIVER INCLUDED

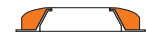

CRI 90

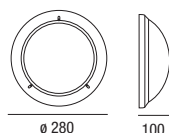

LED Platax BASIC

	colour	W	V	Lm output	K	pcs	Kg	CELL
	B	11	220-240	1000	4000	006	0,850	555523.0101
	B	16	220-240	1400	3000	006	0,850	555638.0101
	B	16	220-240	1400	4000	006	0,850	555611.0101
	N	16	220-240	1400	4000	006	0,850	555612.0101
	B	16	220-240	1400	3000	006	0,850	555638.0101DA
	B	16	220-240	1400	4000	006	0,850	555611.0101DA
	N	16	220-240	1400	4000	006	0,850	555612.0101DA
	B	16	220-240	1400	3000	006	0,850	555640.0101
	N	16	220-240	1400	4000	006	0,850	555614.0101

LED Platax BASIC Emer Sa 2



colour	W	V	K	Flux1 Lm	Flux2 Lm	Lm Output	Flux Lm	Kg	CELL-E
B	16	220-240	4000	600	600	1400	15%	1,160	555616.0101
B	16	220-240	3000	600	600	1400	15%	1,160	555616.3000

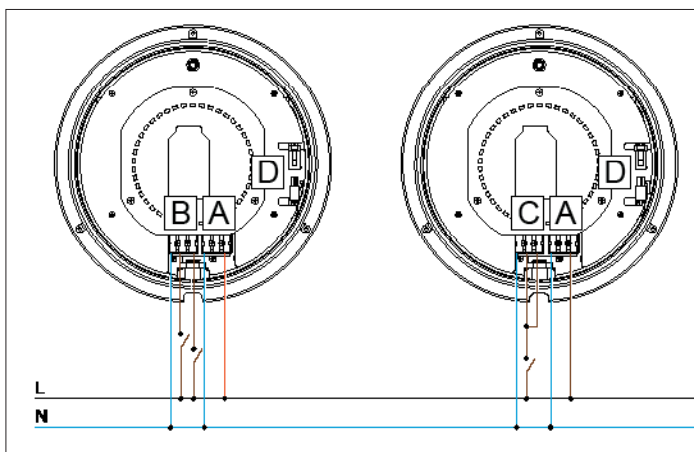

Caratteristiche tecniche

- (A) Linea permanente per la ricarica delle batterie e il funzionamento in emergenza.
- (B) Linea interrotta a due livelli di accensione (50% + 50%) e neutro comune.
- (C) Collegando insieme L1 e L2 si ottiene l'accensione al 100%.
- (D) Il gruppo batterie viene fornito non connesso per non danneggiare gli accumulatori. Eseguire la connessione durante l'installazione

Technical features

- (A) Permanent mains supply (battery recharge and mains failure detection)
- (B) Non permanent mains supply with two light output levels (50% + 50%) with common neutral.
- (C) Join L1 and L2 to have 100% light output level.
- (D) The battery pack comes not connected to the circuit. Connect together male and female connectors.



Outdoor

LED Platax PLUS

A richiesta On demand 1-10Vdc DALI 2

220-240V 50/60Hz

Led Platax PLUS multipotenza

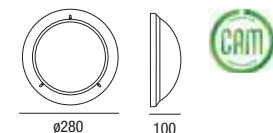

CRI 90



LED Platax Plus

colour	W	V	Lm output	K	pcs	Kg	CELL
B	max 20	220-240	max 1600	3000	006	0,760	555637.PLUS
B	max 20	220-240	max 1600	4000	006	0,760	555523.PLUS
N	max 20	220-240	max 1600	3000	006	0,760	555538.PLUS
N	max 20	220-240	max 1600	4000	006	0,760	555524.PLUS
B	max 20	220-240	max 1600	3000	006	0,760	555637.PLUSDA
B	max 20	220-240	max 1600	4000	006	0,760	555523.PLUSDA

colour	W	V	Lm output	K	pcs	Kg	CELL
B	max 20	220-240	max 1600	3000	006	0,760	555540.PLUS
B	max 20	220-240	max 1600	4000	006	0,760	555613.PLUS

LED Platax Plus Eye

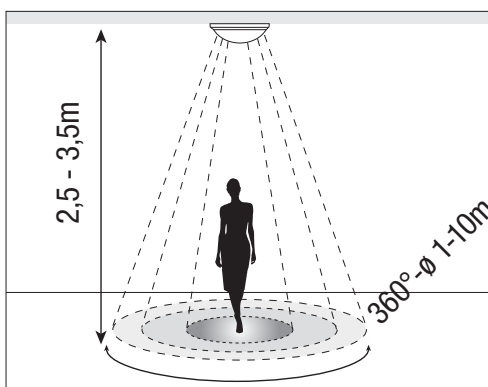
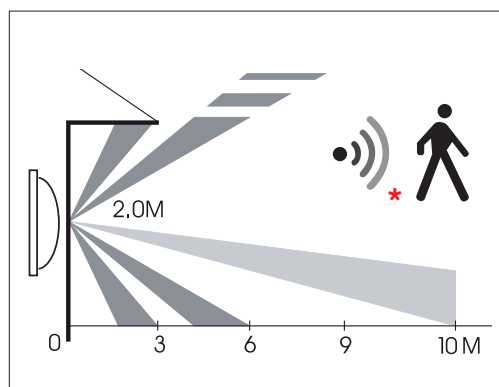

È possibile regolare la sensibilità di rilevamento, la distanza di intervento, la soglia di luminosità ed il tempo di accensione.

The detection sensitivity, intervention distance, luminosity threshold and lighting time can be adjusted.



LED driver (4 poli Dip-Switch) permette di selezionare la potenza desiderata (1-2-3-4) e scegliere il funzionamento necessario.

LED Driver (4 pole Dip-switches) allows you to select the desired power (1-2-3-4) and to select the required connection.

Impostazione standard di fabbrica Driver Standard factory setting

Selezione Dip-Switch Dip-Switch selection				Potenza Power	Lm Output	mA
1	2	3	4	Watt	Lm	mA
•	ON	ON	•	10	750	500
ON	•	ON	•	15	1150	650
ON	ON	ON	•	20	1600	700

Led Platax multipotenza PLUS Emer

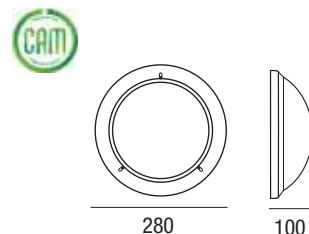

colour	W	V	K	Lm Output	Flux Lm	Kg	CELL-E
B	max 20	220-240	3000	max 1600	15%	1,160	555637.PLUSEM
B	max 20	220-240	4000	max 1600	15%	1,160	555523.PLUSEM
N	max 20	220-240	3000	max 1600	15%	1,160	555568.PLUSEM
N	max 20	220-240	4000	max 1600	15%	1,160	555524.PLUSEM
B	max 20	220-240	3000	max 1600	15%	1,160	555637.PLUSEMS
B	max 20	220-240	4000	max 1600	15%	1,160	555523.PLUSEMS

Caratteristiche tecniche

- (A) Linea permanente per la ricarica delle batterie e il funzionamento in emergenza.
- (B) Non permanent mains.
- (D) Il gruppo batterie viene fornito non connesso per non danneggiare gli accumulatori. Eseguire la connessione durante l'installazione.

Technical features

- (A) Permanent mains supply (battery recharge and mains failure detection).
- (B) Non permanent mains.
- (D) The battery pack comes not connected to the circuit. Connect together male and female connectors.

LED Platax XL

220-240V 50/60Hz

LED Platax XL

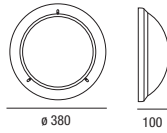

LED Platax XL

	colour	W	V	Lm output	K	pcs	Kg	CELL
	B	22	220-240	2100	3000	006	0,850	555639.0101
	B	22	220-240	2100	4000	006	0,850	555618.0101
	B	22	220-240	2100	3000	006	0,850	555639.0101DA
	B	22	220-240	2100	4000	006	0,850	555618.0101DA
	N	22	220-240	2100	3000	006	0,850	555620.0101
	N	22	220-240	2100	4000	006	0,850	555619.0101
	G	22	220-240	2100	4000	006	0,850	555625.0101
	B	30	220-240	3000	3000	006	0,850	555639.0102
	B	30	220-240	3000	4000	006	0,850	555618.0102
	N	30	220-240	3000	3000	006	0,850	555620.0102
	G	30	220-240	3000	4000	006	0,850	555625.0102

LED Platax XL EYE

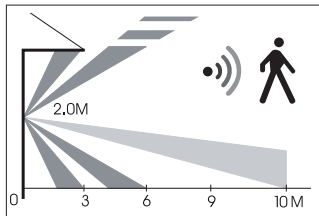

	colour	W	V	Lm output	K	pcs	Kg	CELL
	B	22	220-240	2100	3000	006	0,915	555641.0101
	B	22	220-240	2100	4000	006	0,915	555622.0101
	N	22	220-240	2100	3000	006	0,850	555623.0101
	G	22	220-240	2100	4000	006	0,850	555624.0101
	B	30	220-240	3000	3000	006	0,850	555641.0102
	B	30	220-240	3000	4000	006	0,850	555622.0102
	N	30	220-240	3000	3000	006	0,850	555623.0102
	G	30	220-240	3000	4000	006	0,850	555624.0102

LED Platax XL Emer

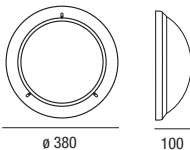

LED Platax XL EMER

	colour	W	V	Lm output	K	pcs	Kg	CELL-E
	B	22	220-240	2100	3000	006	0,850	555639.EMER
	B	22	220-240	2100	4000	006	0,850	555618.EMER
	N	22	220-240	2100	3000	006	0,850	555620.EMER
	B	30	220-240	3000	3000	006	0,850	555639.EMER2
	B	30	220-240	3000	4000	006	0,850	555618.EMER2
	N	30	220-240	3000	3000	006	0,850	555620.EMER2
	B	22	220-240	2100	3000	006	0,950	555639.DAEMER
	B	22	220-240	2100	4000	006	0,950	555618.DAEMER

LED Platax XL EMER EYE

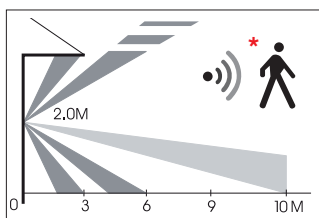

	colour	W	V	Lm output	K	pcs	Kg	CELL-E
	B	22	220-240	2100	3000	006	0,915	555641.EMER
	B	22	220-240	2100	4000	006	0,915	555622.EMER
	N	22	220-240	2100	3000	006	0,850	555623.EMER
	B	30	220-240	3000	3000	006	0,850	555641.EMER2
	B	30	220-240	3000	4000	006	0,850	555622.EMER2
	N	30	220-240	3000	3000	006	0,850	555623.EMER2

È possibile regolare la sensibilità di rilevamento, la distanza di intervento, la soglia di luminosità ed il tempo di accensione.
The detection sensitivity, intervention distance, luminosity threshold and lighting time can be adjusted.

Outdoor

PLATAX E27

Plafoniera compatta stagna idonea per applicazioni civili, commerciali, alberghiere ed ovunque siano richieste caratteristiche di protezione contro l'ingresso di polveri o liquidi.

Corpo e cornice: in nylon rinforzato con fibre di vetro, guarnizione in silicone, vite-ria impermeabile.

Riflettore: in alluminio stampato.

Diffusore: in policarbonato opale antiurto ed autoestinguento.

Cablaggio: alimentazione 220/240V 50/60Hz, cavo non infiammabile HT105°, morsetteria in nylon.

Platax è installabile sia per impianto sotto parete che esterno; l'ingresso cavo è predisposto per un serracavo di diametro 16 mm. Confezione: termo-retraibile.

Compact waterproof fitting suitable for public areas, halls, hotels, passages etc. where dust and water protection is necessary.

Casing and frame: nylon reinforced fibreglass, silicon gasket, non-loosening screws. **Reflector:** Pressed aluminium. **Diffuser:** Self-extinguishing opal shockproof polycarbonate.

Wiring: 220/240V 50/60Hz power supply, HT105° non-flammable cable, nylon connector block.

The cable entry is predisposed for a 16 mm cable gland.

Packaging: thermoretractable film.



220-240V 50/60Hz **IK09** **IP65**

Platax E27



colour	Lampholder	V	pcs	Kg	S
B	E27	220-240	006	0,70	702198.0101
N	E27	220-240	006	0,70	702206.0101
B	2xE27	220-240	006	0,70	702199.0101

Accessori - Accessories



- B** Cod. CO3001.100 - Ø 290mm - Visiera Nylon - Nylon visor
- N** Cod. CO3002.100 - Ø 290mm - Visiera Nylon - Nylon visor

Lampada non inclusa - Not included lamp



W	V			K		lm	Ra	DIM			H mm	Ø mm	Code
8≈(60)	220-240	E27	360°	3000	A	800	80	SI	15.000	25.000	105	60	555286.0101
8≈(60)	220-240	E27	360°	4000	A	800	80	NO	15.000	25.000	105	60	555286.4K
10≈(100)	220-240	E27	360°	3000	A+	1000	80	SI	15.000	25.000	105	60	555383.0101
10≈(100)	220-240	E27	360°	4000	A+	1000	80	NO	15.000	25.000	105	60	555383.4K



Outdoor

LED Luna piena

A richiesta On demand **1-10Vdc** **DALI 2**

LED Luna piena multipotenza

Plafoniera a LED stagna, idonea per applicazioni civili, commerciali, alberghiere.

Corpo e cornice: alluminio pressofuso laccato bianco, grigio e nero di serie, a richiesta versione oro, guarnizione in silicone, viti Torx anti-vandalismo imperdibili.

Verniciatura: di tipo poliestere eseguita a polvere, resistente agli agenti atmosferici e alla corrosione e garantita per 1.000 ore in nebbia salina.

Colore Nero RAL 9005, bianco RAL9010 o grigio RAL 9007

Diffusore: in policarbonato opale, antiurto ed autoestinguente resistente agli UV.

Cablaggio: composto da alimentazione 220-240V 50Hz, cavi in PVC HT 105° non propagante la fiamma, doppio isolamento. LED Luna piena è installabile sia per impianto sotto parete che esterno.

LED Luna piena multipotenza - Con sensore di movimento

Plafoniera a LED con sensore ad alta frequenza a 5,8 GHz. Colorazione neutra e gradevole, intensità e tonalità della luce invariate nel tempo. Sensore invisibile estremamente sensibile e silenzioso nell'accensione, con risposta immediata. È possibile regolare la sensibilità di rilevamento, la distanza di intervento, la soglia di luminosità ed il tempo di accensione.

Caratteristiche tecniche LED Luna piena EMERGENZA SA

Plafoniera Stagna LED con Emergenza integrata.

Il Gruppo di Emergenza interviene automaticamente in caso di interruzione della rete elettrica.

- Flusso luminoso costante in emergenza.
- Spegnimento automatico per sottotensione di batteria.
- Batteria a 3 elementi 3,6 V, 4 A/h.
- Tempo di ricarica massimo 24 ore
- Autonomia 3h, con flusso al 15%.
- Spia LED di attivazione del circuito di ricarica.

Conforme alla norma: EN60598-1, RGO nessun rischio fotobiologico ai fini della norma EN62471.

Led: mantenimento del flusso luminoso minimo al 80%: 50.000h (L80B10).

Driver multipotenza : incluso.

Grado IP: IP65 certificato da laboratorio accreditato

Bianco, nero e grigio di serie.

Standard white, black and gray.

LED Luna piena multipower

Compact waterproof LED fitting suitable for civil, commercial, hotel applications, etc.

Body and frame: white, gray and black lacquered die-cast aluminum as standard, on request gold, silicone gasket, non-loosening Torx screws.

Painting: polyester powder type, resistant to atmospheric agents and corrosion and guaranteed for 1,000 hours in saline mist.

Color Black RAL 9005, white RAL9010 or grey RAL 9007

Diffuser: made by shockproof and self-extinguishing opal polycarbonate, UV resistant.

Wiring: includes 220-240V 50Hz control gear, non-flame propagating PVC HT 105° cables, double insulated. LED Luna piena can be installed in both concealed and outdoor circuits.

LED Luna piena Eye - with motion sensor

Fitting with 5.8 GHz high-frequency sensor with neutral and pleasant colour, unaltered light intensity over time, extremely sensitive invisible sensor and silent switching-on, with instant response. The detection sensitivity, intervention distance, luminosity threshold and lighting time can be adjusted.

LED Luna piena Emergency SA Technical features

Water Proof LED fitting with integrated Emergency Kit integrated.

Emergency Kit turns on when power is cut.

- Non stop light flow during emergency.
- Under voltage lockout.
- Battery with 3 elements 3,6V, 4 A/h included.
- Charging time max 24 hours.
- Autonomy 3h with flux 15%.
- LED Monitor to indicate mains-on conditions.

According to standard: EN60598-1, RGO exempt from photo-biological risks in compliance with standard EN62471.

Led: maintenance of minimum luminous flux to 80%: 50.000h (L80B10).

Driver multipower : included.

IP degree: IP65 certified by an external laboratory

Oro a richiesta
Gold on demand



A richiesta: versione 3000K e 6000K
On demand: 3000K and 6000K versions

220-240V 50/60Hz

LED Luna piena BASIC

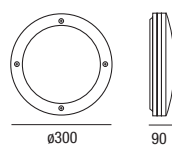

CRI > 80

DRIVER INCLUDED

+40 C°
-20 C°

FLICKER FREE

RGO



colour	W	V	Lm output	K	pcs	Kg	CELL
B	20	220-240	1800	4000	006	1,900	28922/BASIC
B	25	220-240	2300	4000	006	1,900	28922-25BASIC
B	30	220-240	2800	4000	006	1,900	28922-30BASIC
B	30	220-240	2800	4000	006	1,900	28922-30BASICE

Esempio di installazione in linea continua - Continuous line installation example

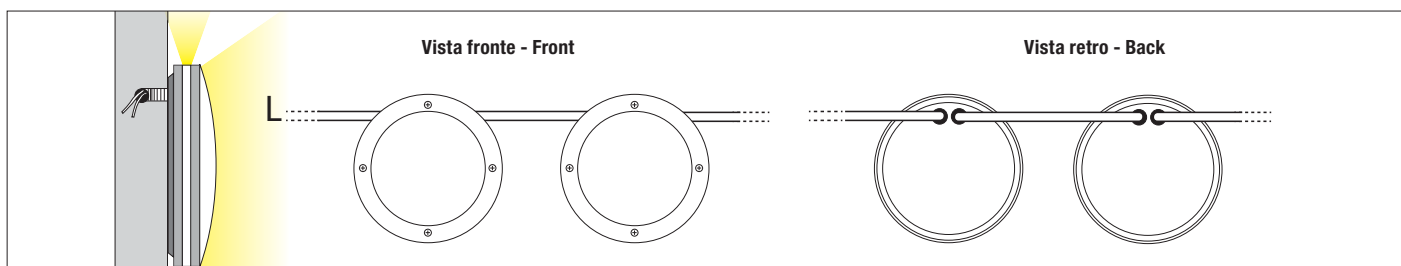

LED Luna piena max 20W

220-240V 50/60Hz 850° **IK10** **IP65**

LED Luna piena multipower

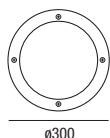

CRI > 80

DRIVER INCLUDED
MULTIPOWER

+40
C°
-20

FLICKER FREE

RG0



LED Luna piena max 20W

colour	W	V	Lm output	K	pcs	Kg	CELL
N	max 20	220-240	1800	4000	006	1,900	28920
G	max 20	220-240	1800	4000	006	1,900	28921

LED Luna piena max 20W EYE

colour	W	V	Lm output	K	pcs	Kg	CELL
B	max 20	220-240	1800	4000	006	1,900	28925
N	max 20	220-240	1800	4000	006	1,900	28923
G	max 20	220-240	1800	4000	006	1,900	28924

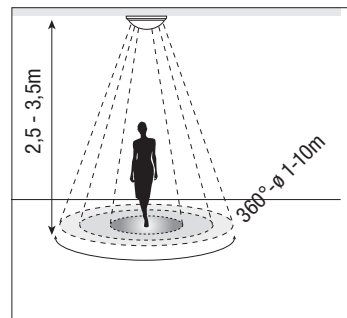
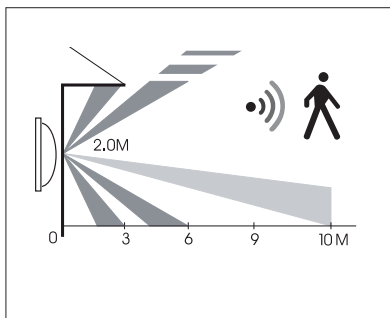
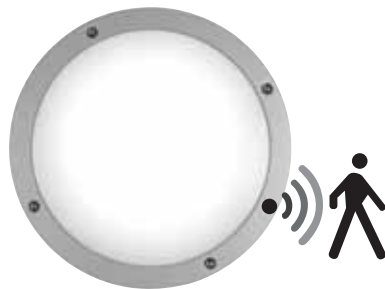

È possibile regolare la sensibilità di rilevamento, la distanza di intervento, la soglia di luminosità ed il tempo di accensione.

The detection sensitivity, intervention distance, luminosity threshold and lighting time can be adjusted.

Selezione Dip-Switch Dip-Switch selection				Power	Lm Output	mA
1	2	3	4	Watt	Lm	mA
•	ON	ON	•	10	950	450
ON	•	ON	•	15	1450	650
ON	ON	ON	•	20	1800	900

Impostazione standard di fabbrica
Driver Standard factory setting



LED Luna piena Emer Sa



colour	W	V	K	Lm Output	Flux Lm	Kg	CELL-E
B	20	220-240	4000	1800	15%	1,900	28928
N	20	220-240	4000	1800	15%	1,900	28926
G	20	220-240	4000	1800	15%	1,900	28927
B	20	220-240	4000	1800	15%	1,900	28928/EYE

Funzionamento in emergenza - Emergency functioning

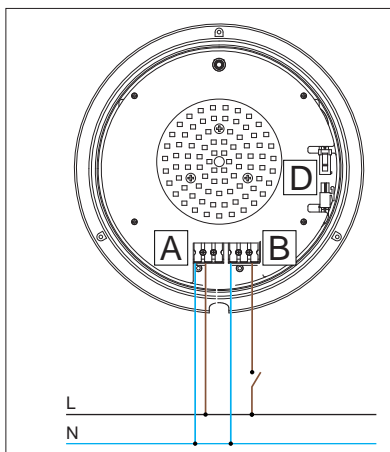

Caratteristiche tecniche

- (A) Linea permanente per la ricarica delle batterie e il funzionamento in emergenza.
- (B) Linea interrotta.
- (D) Il gruppo batterie viene fornito non connesso per non danneggiare gli accumulatori. Eseguire la connessione durante l'installazione

Technical features

- (A) Permanent mains supply (battery recharge and mains failure detection)
- (B) Non permanent mains.
- (D) The battery pack comes not connected to the circuit. Connect together male and female connectors.



BASIC series LED Kamaleon, IP65



LED Kamaleon 6 lampade in una.

Plafoniera a LED stagna, idonea per applicazioni civili, commerciali, alberghiere, disponibile in 2 misure $\varnothing 250\text{mm}$ e $\varnothing 350\text{mm}$, con possibilità di scelta tra tre diverse temperature di colore, bianco caldo, bianco neutro o bianco freddo e con scelta della potenza tra 12W, 15W, 18W per la misura più contenuta e 18W, 24W o 30W per la misura più grande.

Corpo e cornice: in nylon rinforzato con fibre di vetro, guarnizione in silicone, viti Torx anti-vandalo imperdibili.

Diffusore: in policarbonato opale, antiurto ed autoestinguento.

Cablaggio: composto da alimentazione 220-240V 50Hz, cavi in PVC HT 105° non propagante la fiamma, doppio isolamento. Installabile sia per impianto sotto parete che esterno; fornita di serie con pressacavo in nylon PG13,5.

Kamaleon LED 6 lamps in one.

Watertight LED ceiling light, suitable for civil, commercial, hotel applications, available in 2 sizes $\varnothing 250\text{mm}$ and $\varnothing 350\text{mm}$, with the possibility of choosing between three different color temperatures, warm white, neutral white or cold white and with a choice of power between 12W, 15W, 18W for the smallest size and 18W, 24W or 30W for the largest size.

Body and frame: in nylon reinforced with glass fibers, silicone gasket, captive vandal-proof Torx screws.

Diffuser: in opal polycarbonate, shockproof and self-extinguishing.

Wiring: composed of 220-240V 50Hz power supply, non-flame propagating 105 ° PVC cables, double insulation. Can be installed both for under-wall and external systems; supplied as standard with PG13.5 nylon cable gland.



[6 in 1]

[6 in 1]

Cambia la cornice con un semplice click! scegli tra 3 colori diversi grigio, nero e bianco (da ordinare a parte).
Change the frame with a simple click! choose between 3 different colors gray, black and white (on demand).

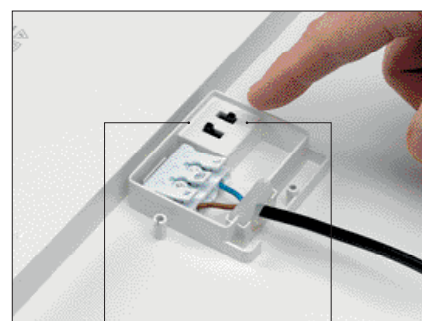
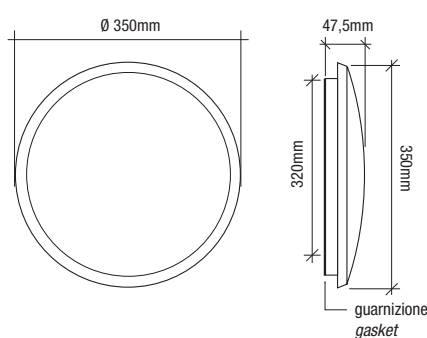
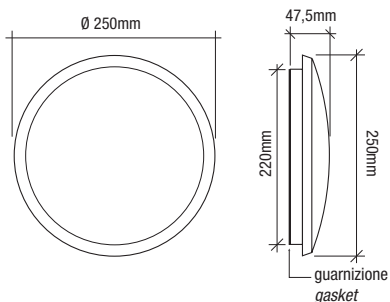

LED Kamaleon $\varnothing 250\text{mm}$

Color	Code	W	K
□	2591	12/15/18	3000
			4000
			6000

Sorgente Source **SMD LED**

Flusso luminoso max. Lighting output max. 1200/1500/1800 Lm

Peso kg weight kg 0,75



220-240V 50/60Hz DRIVER INCLUDED

LED Kamaleon $\varnothing 350\text{mm}$

Color	Code	W	K
□	2592	18/24/30	3000
			4000
			6000

Sorgente Source **SMD LED**

Flusso luminoso max. Lighting output max. 1800/2400/3000 Lm

Peso kg weight kg 0,85



220-240V 50/60Hz DRIVER INCLUDED

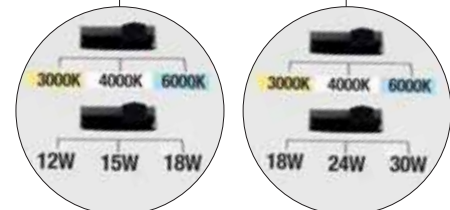



Outdoor

ACCESSORIO Cornice per Kamaleon NON INCLUSA
Kamaleon Frame ACCESSORY NOT INCLUDED



+



Corpo lampada - Body lamp

Color



Code	Ø mm
2591	250
2592	350

Cornice - Frame

Color



Code	Ø mm
2591/W	250
2592/W	350

Cornice - Frame

Color



Code	Ø mm
2591/G	250
2592/G	350

Cornice - Frame

Color



Code	Ø mm
2591/B	250
2592/B	350

LED Aster

Design: Ezio Didone

LED Aster è una lampada da parete/soffitto, molto versatile, pratica e poco ingombrante. Adatta ad illuminare spazi interni ed esterni, con grado IP65. L'illuminazione è uniforme e diffusa.

Particolarmente indicata per corridoi, bagni, balconi, ingressi ed aree provviste di sistemi antincendio ad umido (sprinkler's).

Corpo: alluminio pressofuso

Diffusore: in vetro temprato con finitura satinata.

Guarnizione: in silicone trasparente

Verniciatura: a polveri termoindurenti poliestere, resistente alla corrosione e agli agenti atmosferici.

Sorgente: LED 5630  SEOUL SEMICONDUCTOR

Disponibile nei colori: Bianco verniciato - Nero verniciato - Alluminio spazzolato

Aster LED is a wall/ceiling lamp, very versatile, practical and compact. Suitable for indoor and outdoor lighting, with IP65 degree.

Lighting is uniform and diffused.

Particularly suitable for corridors, bathrooms, balconies, entrances and areas with sprinkler fire systems.

Body: die cast aluminium

Diffuser: in tempered glass with satin finish.

Gasket: in transparent silicone

Painting: with polyester-powder thermohardening, against corrosion and atmospheric agents.

Source: LED 5630  SEOUL SEMICONDUCTOR

Available in the following colours: Painted white - Painted black - Aluminium Brushed



Outdoor

220-240V 50/60Hz     **IK07** **IP65**

LED Aster

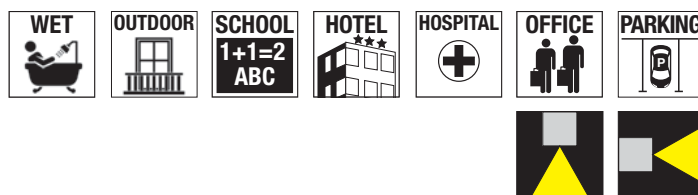

453

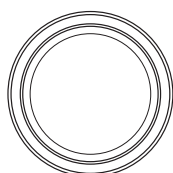

 | 87



colour	W	V	Lm	K	pcs	Kg	CELL
B	30	230	2000	4000	001	2,40	32351/LED
N	30	230	2000	4000	001	2,40	32353/LED
S	30	230	2000	4000	001	2,40	32355/LED

Plafoniere

Ceiling luminaires

Plafoniere a soffitto e/o parete con schermo antivandalo, resistente ai raggi UV e agli agenti atmosferici.

Per l'illuminazione di corridoi, terrazzi e porticati.

Corpo: base in alluminio o materiale termoplastico

Portalamпада: in ceramica

Schermo: in policarbonato o vetro

Cablaggio: tramite morsetteria interna

Provviste di lamella riflettente cromata

Per applicazione con canalina esterna vedi Pag. 135

Durable tamperproof and watherproof ceiling and wall lights.

Ideal for lighting corridors, terraces, porches, paths and damp environments in general.

Body: aluminium or thermoplastics

Lamp holder: ceramic

Shield: polycarbonate or glass

Wiring: via internal terminal block

For application via external conduit see Page 135





Alluminio + Vetro - Aluminium + Glass



Outdoor

LED 206S

Articolo - Article		Codice - Code		Col.	(mm)	W	Sorgente Source	Lm	K	QTY	Euro Netto
	LED 206S IP65 IK08		206S/BIALED3	CELL	White	210x145x100	Led Module Acrich 2 SEOUL	350	3000	700	8,00
			206S/NERLED3	CELL	Black			350	3000	700	8,00
			206S/LED3	CELL	Grigio			350	3000	350	8,00

Termoplastico + Vetro - Thermoplastic + Glass



100S



130S



70S

Outdoor

Articolo - Article			Codice - Code		Col.	(mm)	W	Sorgente Source
	100S IP65 IK08		100S/TBIA	S	White	210x120x115	E27 HALO - LED	
			100S/TNER	S	Black			
	130S IP65 IK08		130S/TBIA	S	White	275x155x115	E27 HALO - LED	
			130S/TNER	S	Black			
	70S IP65 IK08		70SA/TBIA	S	White	210x120x100	E27 HALO - LED	
			70SA/TNER	S	Black	210x120x100	E27 HALO - LED	

Termoplastico + Policarbonato - *Thermoplastic + Polycarbonate*



Taormina



Taormina Round - LED Taormina Round



70SG



Articolo - Article		Codice - Code		Col.	(mm)	W	Sorgente Source
	Taormina IP65 IK08		T/E1031/B	S	White	100x190x95	E27
			T/E1031/N	S	Black		
			T/E1031/G	S	Grey		
	Taormina Round IP65 IK08		T/E1033/B	S	White	Ø 191x105	E27 HALO - LED
			T/E1033/N	S	Black		
			T/E1033/G	S	Grey		
	70SG IP68 IK08		70SG/TBIA	S	White	120x210x110	E27 HALO - LED
			70SG/TNER	S	Black		

Outdoor

Termoplastico + Policarbonato - *Thermoplastic + Polycarbonate*



Outdoor

Articolo - Article			Codice - Code		Col.	(mm)	Sorgente Source
	Round grande IP65 IK08		T/E2060/B	S	White	Ø 280x128	E27
			T/E2060/N	S	Black		
	Tekno basic IP65 IK08		T/E1039/B	S	White	170x230x125	E27
	Tekno 2000 media IP65 IK08		T/E2150/B	S	White	130x205x112	E27
			T/E2150/N	S	Black		
	Tekno 2000 grande IP65 IK08		T/E2160/B	S	White	170x260x125	E27
			T/E2160/N	S	Black		

Termoplastico + Policarbonato - *Thermoplastic + Polycarbonate*



150



Top con palpebra

Articolo - Article			Codice - Code		Col.	(mm)	Sorgente Source
	150 IP65 IK08		150/TBIA	S	White	160x270x110	E27
			150/TNER	S	Black		
	Top con palpebra IP65 IK08		T/E1046/B	S	White	Ø 215x130	E27
			T/E1046/N	S	Black		

Dati tecnici per applicazione tramite canalina esterna - *Technical data for application via external conduit*

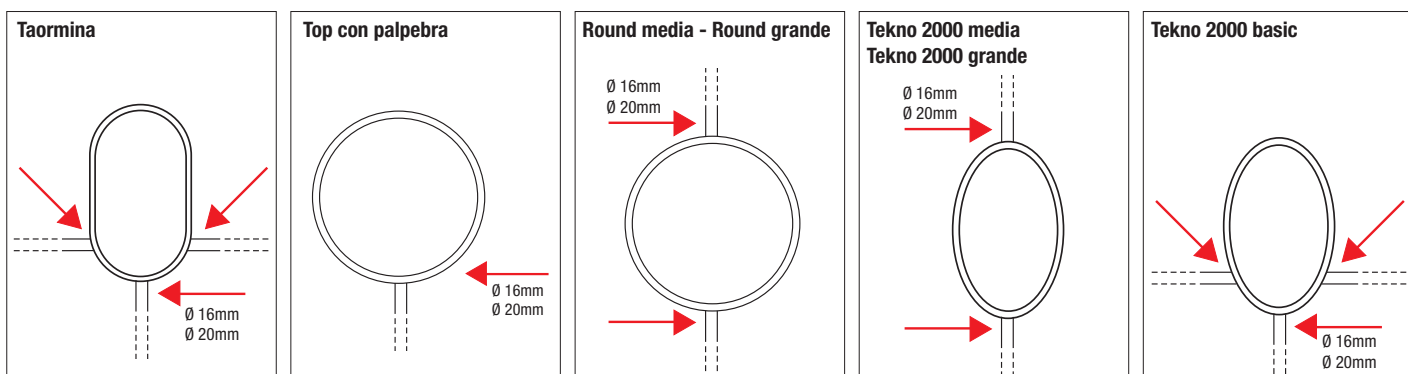

LED Londra - LED Miami

Installazione: dotato di molle in acciaio per un rapido e facile inserimento (es. controsoffitti, pannelli in legno, piastrelle) oppure con cassaforma (accessorio), da murare.

Corpo e ghiera: alluminio cromato, verniciato Grigio (RAL7001) o Bianco (RAL9010). Resistente alla corrosione e agli agenti atmosferici.

Diffusore: lente in vetro piano convessa a 60°; riflettore in alluminio anodizzato

Guarnizione: in gomma silconica.

Sorgente: LED **SAMSUNG**. Mantenimento del flusso luminoso al 80%. 50.000h (L80B20)

Alimentazione: non inclusa; dotato di 50cm di cavo FROR PVC 2x0,5mm².

Installation: with steel springs for quick and easy insertion (e.g. in false ceilings, wooden panels and tiles) or with casing (accessory) for installation in walls.

Housing and setting ring: chromed aluminium, painted grey (RAL7001) or white (RAL9010). It is rustproof and resistant to atmospheric agents.

Shade: flat-convex glass lens at 60°; reflector in anodized aluminium.

Gasket: in silicone rubber.

Source: LED **SAMSUNG**. Maintenance of 80% minimum luminous flux: 50,000h (L80B20).

Power supply: not included with a 50cm of FROR PVC PVC 2x0.5mm² wire.

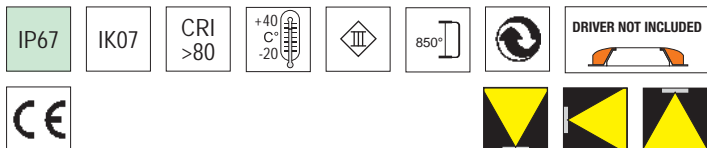
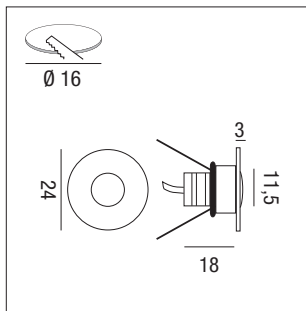
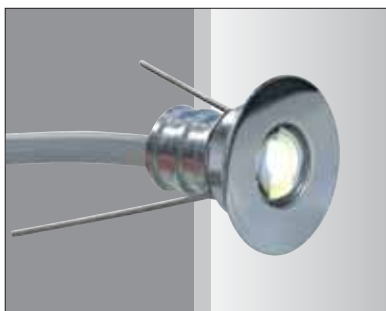
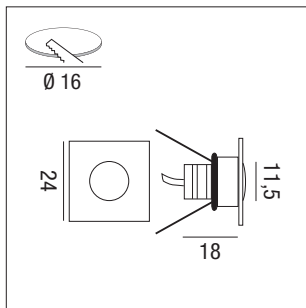

LED Londra								
colour	Max W	mA	Optic	K	lm	pcs	Kg	S + L
B	1	350	60°	3000	120	1	0,02	27343
C	1	350	60°	3000	120	1	0,02	27151

LED Miami								
colour	Max W	mA	Optic	K	lm	pcs	Kg	S + L
B	1	350	60°	3000	120	1	0,02	27345
B	1	350	60°	4000	120	1	0,02	27345-4K
G	1	350	60°	3000	120	1	0,02	27152
C	1	350	60°	3000	120	1	0,02	27152/CR

A richiesta: disponibile nella versione 4000K e 6000K per ordine di almeno 100 pezzi
On demand: available in the 4000K and 6000K version on orders of at least 100 pieces of product

Accessori NON inclusi - NOT included accessories

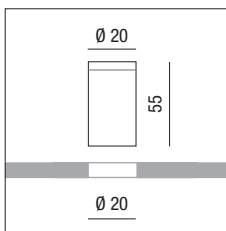

Cod. 000022
Cassaforma
Framework

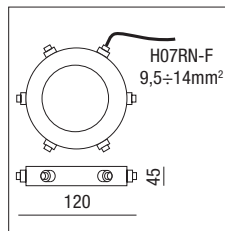

Cod. 12370
Big box - IP68
1 Entrata / 5 Uscite - 1 Input / 5 Outputs

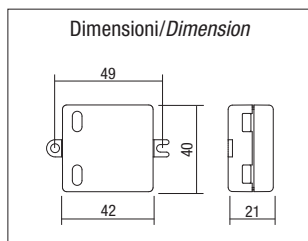
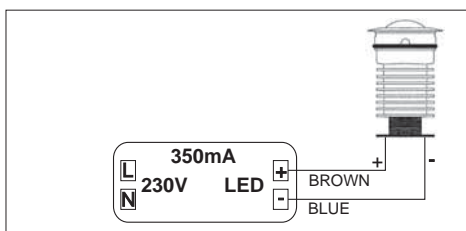

Cod. PTDC/3/350/N
3W

LED Driver per singola installazione
LED Driver for single installation



LED Parigi

Apparecchio a LED per utilizzo indoor e outdoor ad incasso, a pavimento/terreno, parete e soffitto. Prodotto non idoneo per l'installazione in piscine e fontane.
Lo stesso prodotto, se dotato di un accessorio staffa, può essere utilizzato come proiettore architettonico.

Installazione: a pavimento con controcassa, a soffitto con alette di fissaggio

Fascio ottico: regolabile da 20° a 60° grazie ad un sistema di regolazione manuale retrostante o asimmetrico.

Corpo e cornice: in acciaio Inox AISI 304 senza viti a vista

Diffusore: in vetro trasparente temprato

Guarnizione: in gomma siliconica.

Carrabilità: resistenza al carico statico 2.000 Kg tramite controcassa ordinabile separatamente

Alimentazione: a bassa tensione di sicurezza in corrente costante (350mA). Da ordinare separatamente.

Sorgente: LED **SAMSUNG**

LED fixture for indoor and outdoor recessed, floor / ground, wall and ceiling use. Product not suitable for installation in swimming pools and fountains.

The same product, if equipped with a bracket accessory, can be used as an architectural projector.

Installation: on the floor with outer casing, on the ceiling with fixing tabs

Optical beam: adjustable from 20° to 60° thanks to a manual adjustment system behind it or asymmetric.

Body and frame: in AISI 304 stainless steel without visible screws

Diffuser: in transparent tempered glass

Gasket: in silicone rubber.

Drive over: resists the static load 2,000 kg through the outer casing, which can be ordered separately

Power supply: low voltage safety constant current (350mA). To be ordered separately.

*Source: LED **SAMSUNG***

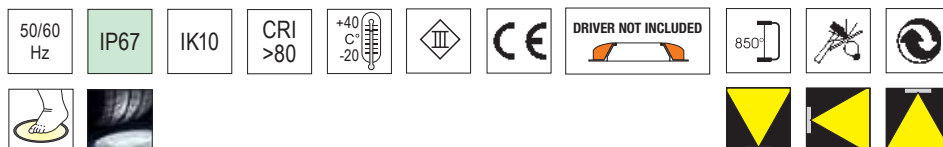

colour	Max W	mA	Optic	K	lm output	lm/W	pcs	Kg	S + L
B	2	350/700	10/60°	6000	100/170	-	1	0,09	27183
B	2	350	10/60°	3000	280	140	1	0,09	27184N
B	2	350	10/60°	4000	280	140	1	0,09	27184/4KN
S	2	350	10/60°	3000	280	140	1	0,09	27160N
S	2	350	10/60°	4000	280	140	1	0,09	27160/4KN

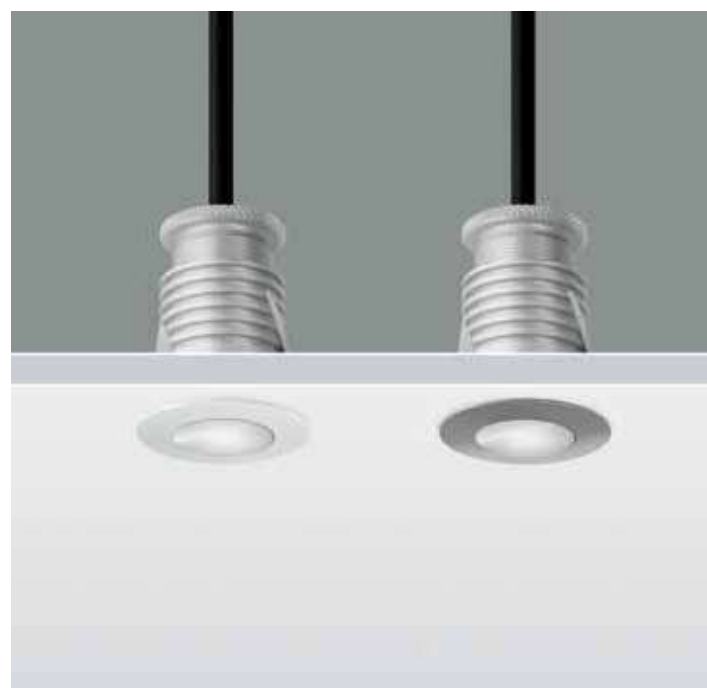
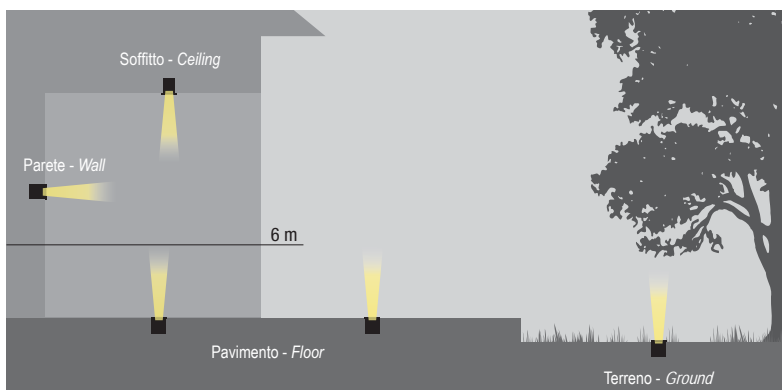
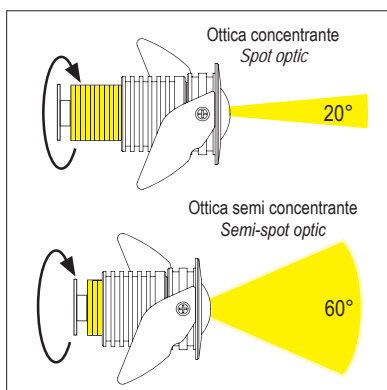
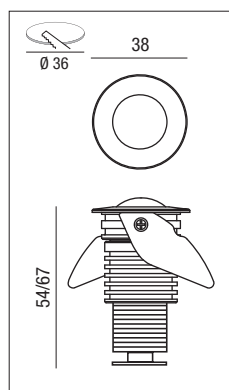

LED Parigi, accessori NON inclusi - *NOT INCLUDED* accessory LED Parigi wall

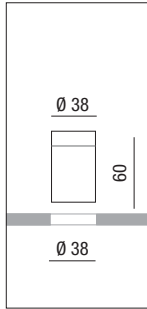

Cod. 27176 /KIT
Staffa a parete
 Montaggio a parete orientabile
Wall bracket
 Adjustable wall mounting

Cod. 27243
 Cassaforma per installazioni su muratura.
 Formwork for walling installations.

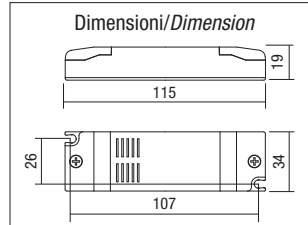
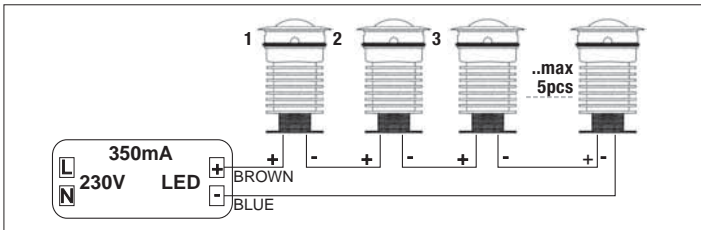

Cod. RN9150-2 - Max 15W - 350mA
 Driver per collegamento in serie - Drivers for series connection



LED Parigi ASY

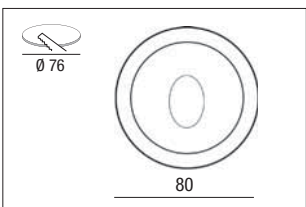

50/60 Hz IP67 IK10 CRI >80 +40°C / -20°C III CE DRIVER NOT INCLUDED 850°



colour	W	mA	Optic	K	lm output	lm/W	pcs	Kg	S + L
B	2	350	10/60°	3000	280	140	1	0,09	27184N/ASY
B	2	350	10/60°	4000	280	140	1	0,09	27184/4KN/ASY
S	2	350	10/60°	3000	280	140	1	0,09	27160N/ASY
S	2	350	10/60°	4000	280	140	1	0,09	27160/4KN/ASY

Recessed



LED Nasca apparecchio da incasso a pavimento/terra/parete adatto per illuminare percorsi pedonali, aree verdi, porticati ed edifici sia residenziali che pubblici.

Corpo: in alluminio pressofuso, struttura in acciaio inox 304.

Diffusore: vetro temprato alto 10 mm, garantisce il superamento del test standard IK10.

Anello: in gomma silicónica resistente alle alte temperature e impermeabile, alloggiamento di installazione in plastica PP resistente alla corrosione.

Cassaforma: in plastica PP resistente alla corrosione.

Rischio fotobiologico: nessun rischio fotobiologico, secondo EN 62471:2008.

Viteria: in acciaio inossidabile 304.

LED Nasca floor/ground/wall recessed luminaire suitable for lighting pedestrian paths, green areas, porches and both residential and public buildings.

Body: in die-cast aluminum, structure in 304 stainless steel.

Diffuser: 10mm high tempered glass, ensure pass IK10 standard test.

Ring: high temperature resistant and waterproof silicone rubber, corrosion resistant PP plastic installation housing.

Formwork: Corrosion resistant PP plastic.

Photobiological risk: no photobiological risk, according to EN 62471:2008.

Screws: in 304 stainless steel.

A richiesta - On demand

1-10Vdc

DALI 2

DYNA

Wireless

Vedi Pag. VI - See page VI

24 Vdc IP67 IK10 CRI > 80 +40°C -20°C CE EN 18

Driver included



Ottica 30° - Optic 30°



Temperatura inferiore a 40°C - Temperature below 40 °C



Resistenza al carico statico (5000 Kg) - Resistance to static load (5000 Kg)

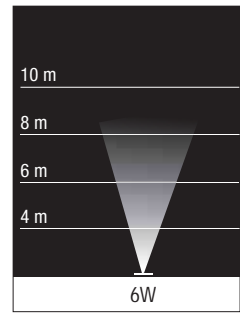

colour	W	angle	K	Max Lumen	Lm/W	pcs	Kg	CELL
S N	6	30°	3000	480	80	1	0,54	RM-03

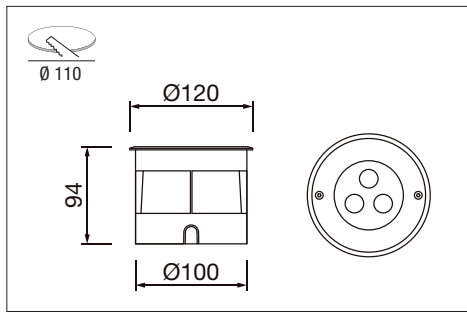

Installazione a terra
Ground installation



Installazione a pavimento
Floor installation



Installazione a parete
Wall installation

Vetro temperato
Hardened tempered glass

Telaio in acciaio inox 304
304 stainless steel frame

Ottica più performante
Higher performance optic

Custodia di installazione in plastica PP
PP plastic installation housing



Selezioniamo materiali della massima qualità possibile, per garantire una qualità del prodotto di alto livello. Vetro temperato ad alta resistenza con protezione fino a IK10, corpo di installazione in plastica PP, ottiche dal design speciale per mantenere i livelli di prestazioni dell'apparecchio più elevati.

We select materials of highest possible quality, to ensure high-degree product quality. High sturdy tempered glass with protection up to IK10, PP plastic installation housing, special design optics to keep the fixture higher performance levels.

Recessed

LED Venezia, per l'illuminazione di luoghi come piazze, edifici, sculture e insegne.

- **Corpo e alloggiamento:** in acciaio inossidabile tipo 304.
- **Corpo:** in alluminio puro.
- **Vetro:** temperato trasparente da 15 mm, il carico statico dell'apparecchio può resistere a 5000 kg.
- **Modulo:** il modulo di illuminazione ha un sistema di inclinazione regolabile e ha un'ottica ad alte prestazioni.
- **Installazione:** a scatto.
- L'apparecchio di illuminazione può funzionare in modo continuo di lunghezze standard.
- Resistente all'acqua, è sicuro e affidabile per l'uso.
- La temperatura superficiale massima di tutte le temperature di contatto <50°C per sicurezza e affidabilità.
- Tutte le viti esterne sono realizzate in acciaio inossidabile 304.
- Le caratteristiche tecniche dell'apparecchio sono conformi alle norme EN 60598-1.

LED Venezia, for landscape lighting places such as square, buildings, sculptures and signs.

- **Body and housing:** stainless steel type 304 body and installation housing.
- **Body:** Pure aluminium construction fixture body.
- **Glass:** clear tempered glass 15 mm, the static load of the luminaire can resistance 5000kg.
- **Module:** the lighting module has tilt adjustable system, and it has high performance optics.
- **Installation:** snap in installation with no exposed hardware
- The luminaire can continuous run of standard lengths.
- Supplied with oil and water resistant, it is safety and reliable for using.
- The maximum surface temperature of all contact temperature <50°C for safety and reliable.
- All external screw are made of 304 stainless steel.
- The luminaire technical characteristics conform to EN 60598-1 standards.

A richiesta - On demand

1-10Vdc



DYNA

Wireless

Vedi Pag. VI - See page VI

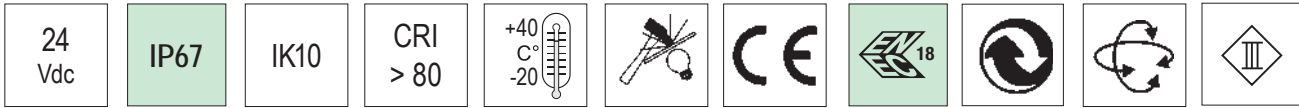

Driver NOT included

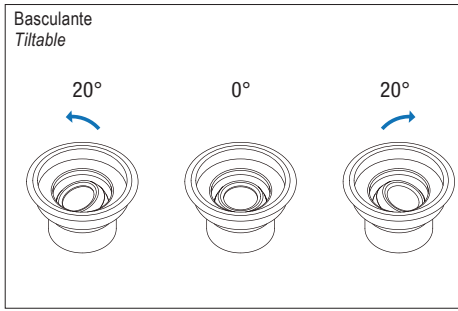
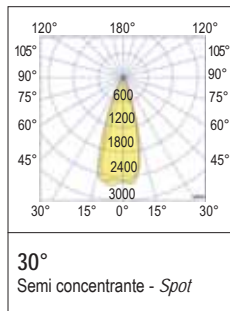

Il prodotto si applica con un design speciale, fornendo la soluzione di illuminazione più efficace per il comfort visivo, evitando abbagliamenti inutili e riducendo l'inquinamento luminoso, la direzione della luce regolabile.

The product apply with special design, providing the most effective lighting solution for visual comfort, avoiding unnecessary glare and reducing light pollution, the light direction adjustable.

colour	W	angle	K	Lumen	Lm/W	pcs	Kg	S + L
S N	10	30°	3000	800	80	1	1,80	RL21310-1

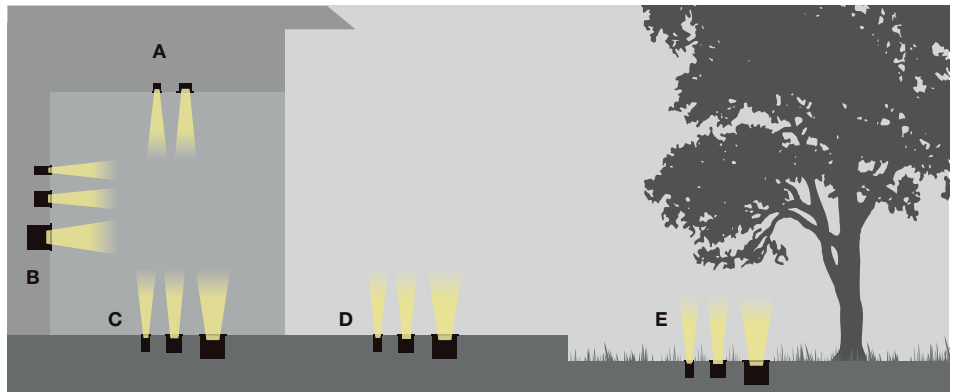
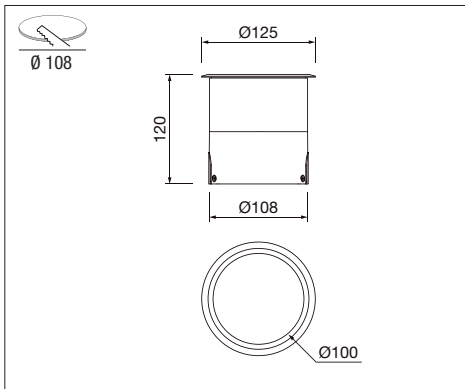

A Soffitto - Ceiling B Parete - Wall C Interno pavimento - Indoor floor D Esterno pavimento - Outdoor floor E Terreno - Ground

Gli incassi a terra e a pavimento, hanno diversi gradi di resistenza alla torsione e al taglio, fino a 5000 Kg secondo EN 60598-2-13.

Ground and floor level recessed luminaires, have different degrees of resistance to torsion and shear, up to 5000 Kg in accordance with EN 60598-2-13.



Temperatura inferiore a 40°C
Temperature below 40 ° C



Versione con ottica diffusore completo di vetro antiscivolo
Diffuser optics versions complete with non-slip glass



Resistenza al carico statico (5000 Kg)
Resistance to static load (5000 Kg)



Recessed

LED Firenze, per l'illuminazione di luoghi come piazze, edifici, sculture e insegne.

- **Corpo:** in acciaio inossidabile tipo 304, custodia di installazione in ABS / acciaio inossidabile tipo 304.
- **Vetro:** temperato trasparente da 15 mm. Il carico statico dell'apparecchio può resistere a 5000 kg.
- **Ottica:** buon design, speciale per ottica ad alte prestazioni, e sistema antiriflesso.
- **Installazione:** a scatto senza.
- Resistente all'acqua, è sicuro e affidabile per l'uso.
- La temperatura superficiale massima di tutte le temperature di contatto <50°C per sicurezza e affidabilità.
- Tutte le viti esterne sono realizzate in acciaio inossidabile 304.

LED Firenze, for landscape lighting places such as square, buildings, sculptures and signs.

- **Body:** stainless steel type 304 body, ABS stainless steel type 304 installation housing.
- **Glass:** clear tempered glass 15 mm, the static load of the luminaire can resistance 5000kg.
- **Optic:** special good design for high performance optics and anti glare system.
- **Installation:** snap in installation with no exposed hardware
- Supplied with oil and water resistant, it is safety and reliable for using.
- The maximum surface temperature of all contact temperature <50°C for safety and reliable.
- All external screw are made of 304 stainless steel.
- The luminaire technical characteristics conform to EN 60598-1 standards.

A richiesta - On demand

1-10Vdc

DALI 2

DYNA

Wireless

Vedi Pag. VI - See page VI

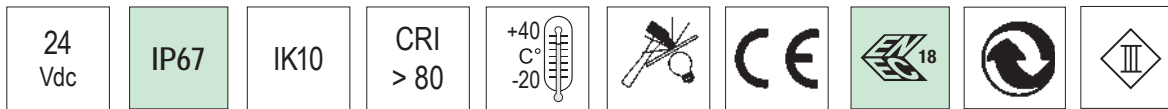

Driver NOT included

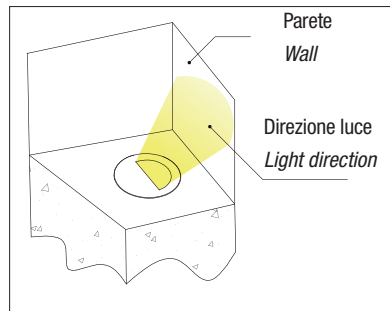
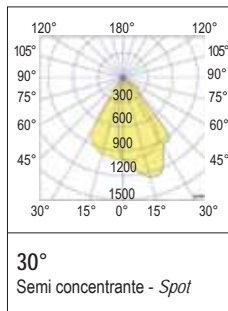

Il prodotto si applica con un design speciale, fornendo la soluzione di illuminazione più efficace per il comfort visivo, evitando abbagliamenti inutili e riducendo l'inquinamento luminoso.

The product apply with special design, providing the most effective lighting solution for visual comfort, avoiding unnecessary glare and reducing light pollution.

colour	W	angle	K	Lumen	Lm/W	pcs	Kg	S + L
S N	6	30	3000	500	83	1	1,50	RL2146-2

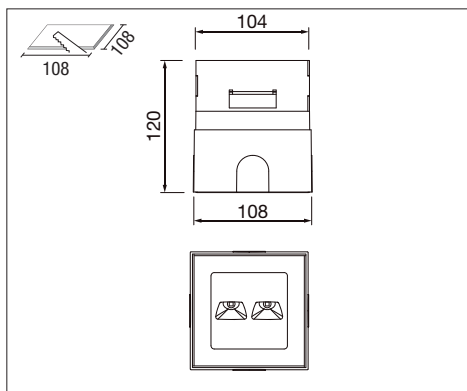

Selezioniamo materiali della massima qualità possibile, per garantire una qualità del prodotto di alto livello. Vetro temperato ad alta robustezza con protezione fino a IK10, corpo di installazione in acciaio inox 304, riflettore dal design speciale per mantenere l'apparecchio a livelli prestazionali più elevati.

We select materials of highest possible quality, to ensure high-degree product quality. High sturdy tempered glass with protection up to IK10, 304 stainless steel installation housing, special design reflector to keep the fixture higher performance levels.

Gli incassi a terra ea terra, hanno diversi gradi di resistenza alla torsione e al taglio, fino a 5000 Kg secondo EN 60598-2-13.

Ground and floor level recessed luminaires, have different degrees of resistance to torsion and shear, up to 5000 Kg in accordance with EN 60598-2-13.



Temperatura inferiore a 40°C
Temperature below 40 ° C



Versione con ottica diffusore completo di vetro antiscivolo
Diffuser optics versions complete with non-slip glass



Resistenza al carico statico (5000 Kg)
Resistance to static load (5000 Kg)



Installato a filo pavimento
Installed flush with floor



Recessed

Apparecchio da incasso a pavimento/terra/parete previsto per le applicazioni secondo necessità. Luce laterale radiale ad emissione unilaterale e bidirezionale, con elevato comfort visivo e buon effetto antiriflesso.

Corpo: in alluminio pressofuso- Alluminio RAL 9005
Diffusore in pc di alta qualità.

Anello: in gomma siliconica resistente alle alte temperature e impermeabile

Cassaforma: in plastica PP resistente alla corrosione.

Rischio fotobiologico: nessun rischio fotobiologico, secondo EN 62471:2008.

Viteria: in acciaio inossidabile 304.

Floor/ground/wall-mounted recessed luminaire intended applications as required.

Side radial light with unilateral & bidirectional emission, it with high visual comfort and good anti glare effect.

Body: die-casting aluminium body. RAL 9005 aluminium

Diffuser: high quality pc diffuser.

Rubber ring: high temperature resistant and waterproof silicone rubber ring

Housing: corrosion resistant PP plastic installation housing.

Photo-biological risk: no photo-biological risk, in accordance with EN 62471:2008.

Screws: all external screw are made of 304 stainless steel.

A richiesta - On demand

1-10Vdc

DALI 2

DYNA

Wireless

Vedi Pag. VI - See page VI

24 Vdc	IP67	IK09	CRI > 80	+40 C -20		CE	EN 18		
-----------	------	------	-------------	-----------------	--	----	-------	--	--

Driver NOT included

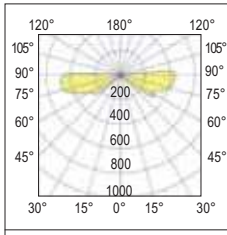

120°
Semi concentrante - Spot



Temperatura inferiore a
40°C - Temperature below
40 ° C



Resistenza al carico statico
(5000 Kg) - Resistance to
static load (5000 Kg)



colour	W	angle	K	Lumen	Lm/W	pcs	Kg	S+L
S N	2	120°	3000	140	70	1	0,54	RLM-01A

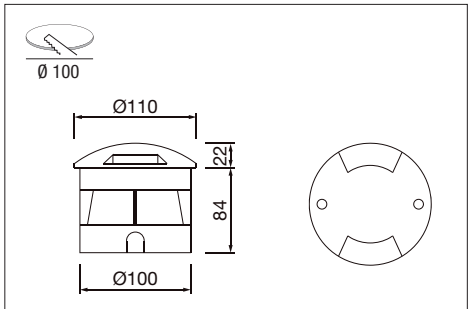

Installazione a terra
Ground installation



Installazione a pavimento
Floor installation



Installazione a parete
Wall installation



Recessed

Apparecchio da incasso a pavimento/terra/parete previsto per le applicazioni secondo necessità. Luce laterale radiale ad emissione bidirezionale, con elevato comfort visivo e buon effetto antiriflesso.

Corpo: in alluminio pressofuso. Alluminio RAL 9005

Diffusore: in pc di alta qualità.

Anello: in gomma siliconica resistente alle alte temperature e impermeabile

Cassaforma: in acciaio zincato a caldo.

Rischio fotobiologico: nessun rischio fotobiologico, secondo EN 62471:2008.

Viteria: in acciaio inossidabile 304.

Floor/ground/wall-mounted recessed luminaire intended applications as required. Side radial light with unilateral & bidirectional emission, it with high visual comfort and good anti glare effect.

Body: die-casting aluminium body. RAL 9005 aluminium

Diffuser: high quality pc diffuser.

Rubber ring: high temperature resistant and waterproof silicone rubber ring

Housing: in hot galvanized steel.

Photo-biological risk: no photo-biological risk, in accordance with EN 62471:2008.

Screws: all external screw are made of 304 stainless steel.

A richiesta - On demand

1-10Vdc

DALI 2

DYNA

Wireless

Vedi Pag. VI - See page VI

24 Vdc	IP67	IK09	CRI > 80	+40 C -20		CE	EN 18		
-----------	------	------	-------------	-----------------	--	----	-------	--	--

Driver NOT included

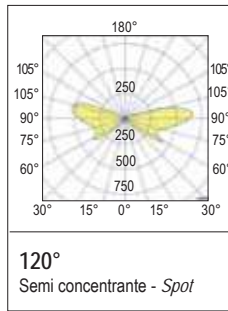

Temperatura inferiore a
40°C - Temperature below
40 ° C



Resistenza al carico statico
(5000 Kg) - Resistance to
static load (5000 Kg)



colour	W	angle	K	Lumen	Lm/W	pcs	Kg	S+L
S	4	120°	3000	280	70	1	0,83	RLM-16A

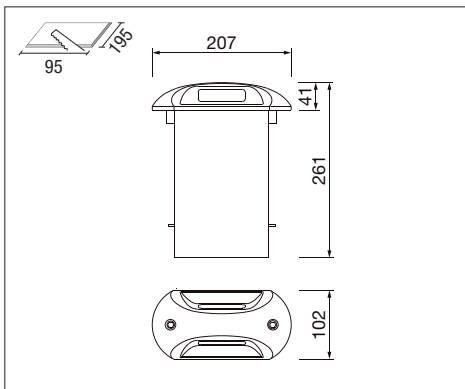

Installazione a terra
Ground installation



Installazione a pavimento
Floor installation



Installazione a parete
Wall installation



Recessed

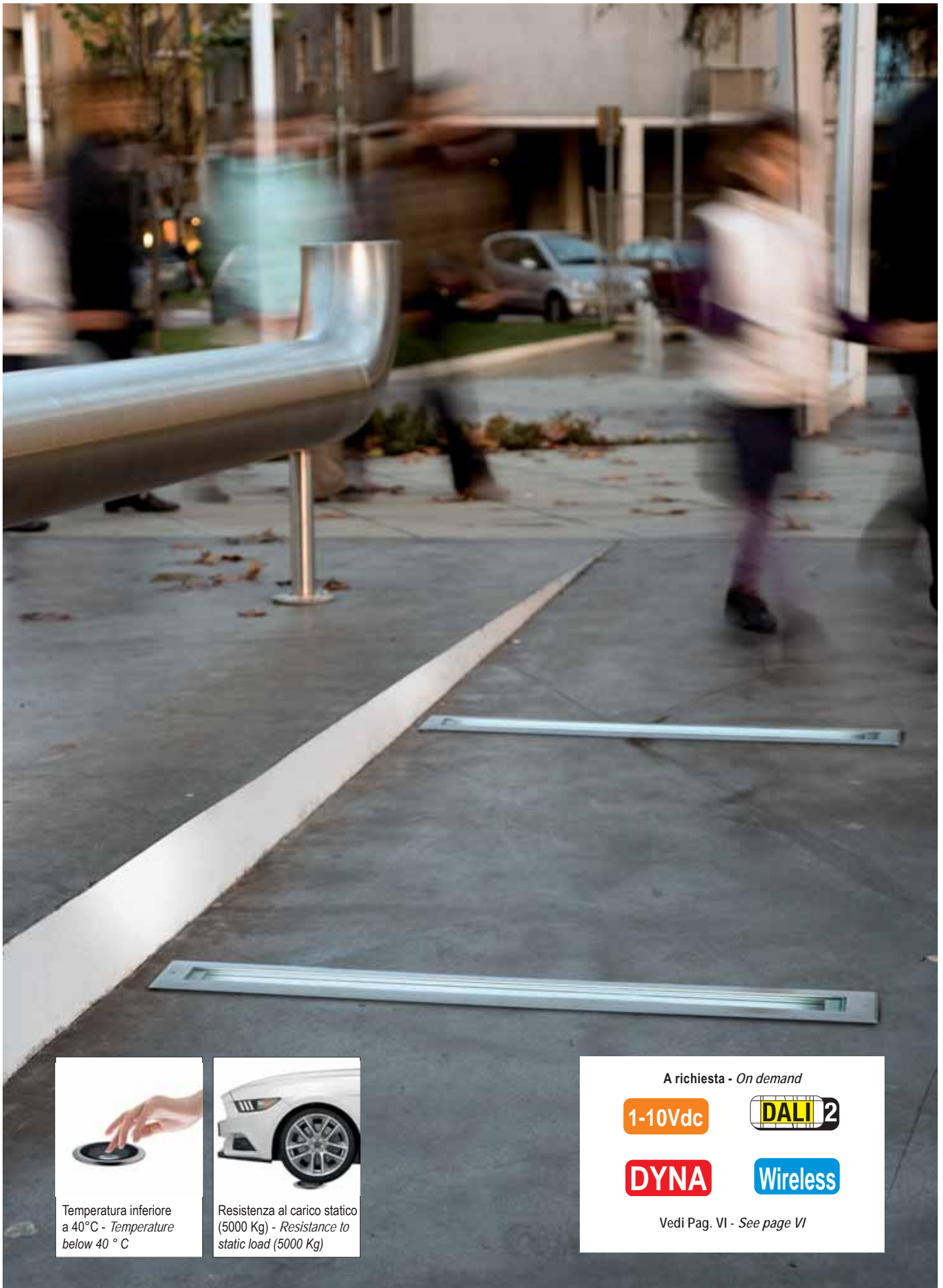

Temperatura inferiore a 40°C - Temperature below 40 ° C



Resistenza al carico statico (5000 Kg) - Resistance to static load (5000 Kg)

A richiesta - On demand

1-10Vdc



DYNA

Wireless

Vedi Pag. VI - See page VI

LED Monocilindrico

Apparecchio a LED da incasso per aree urbane e residenziali. Adatto per illuminare edifici, monumenti e strade.

Installazione: a pavimento con cassaforma

Corpo e cornice: estruso in alluminio anodizzato minimo 20 micron

Cornice esterna: cornice esterna 316 L cromo satinato

Diffusore: in vetro trasparente temprato

Guarnizione: in gomma siliconica.

Carrabilità: calpestabile e carrabile, fino a 10Km/h - 1000 Kg con pneumatici gonfiati ad aria. Non sostare.

Alimentazione: Da ordinare separatamente.

Copertura laterale iniezione in alluminio

Recessed LED luminaire for urban and residential areas. Suitable for illuminating buildings, monuments and streets.

Installation: on the floor with formwork

Body and frame: extruded anodized aluminum at least 20 micron

External frame: external frame 316 L satin chrome

Diffuser: in tempered transparent glass

Gasket: silicone rubber.

Drive-over: walkable and drive-over, up to 10Km / h - 1000kg with air-inflated tires. Don't stop.

Power supply: To be ordered separately.

Aluminum injection side cover

24
Vdc

IP67

IK10

CRI
> 85

+45
C°
-30

Driver NOT included



colour	W	angle	K	nominal Im tc = 25°C	Im output	lm/W	pcs	Kg	S + L
C	24	25°	4000	2.600	2.225	92	1	4,00	RL218NWM01
C	24	25°	3000	2.600	2.225	92	1	4,00	RL218WWM01
C	48	25°	4000	5.000	4.320	90	1	7,30	RL436NWM01
C	48	25°	3000	5.000	4.320	90	1	7,30	RL436WWM01

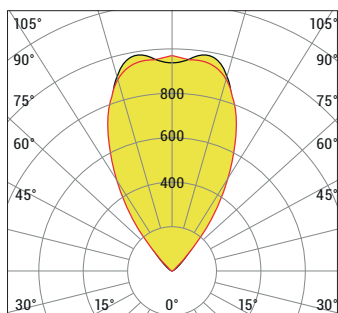
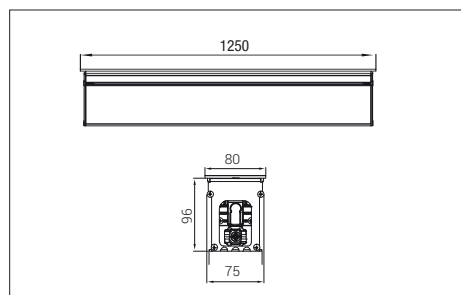
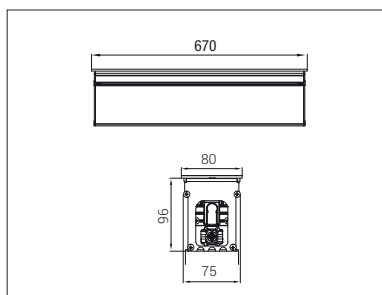

H (mt)	Ø (m)	E _{max} (lx)
3.0	3,59	102
1.5	2,99	147
2.0	2,39	230
1.5	1,8	408
1.0	1,20	919
0.5	0,60	3674

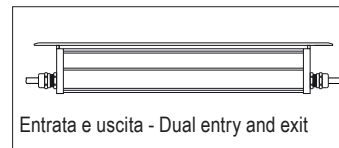
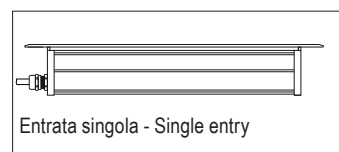
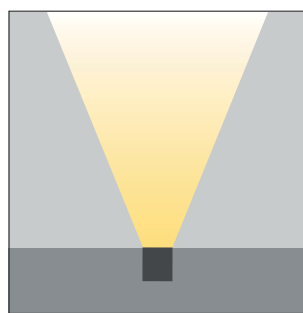

A richiesta - On demand

Angolo extra stretto
Extra narrow angle

Angolo ampio
Wide angle

Senza lente
Without lens

Asimmetrico
Asymmetrical

Ellittico stretto
Elliptical narrow

Ellittico medio
Elliptical medium

Recessed

LED Rondò - LED Naasby

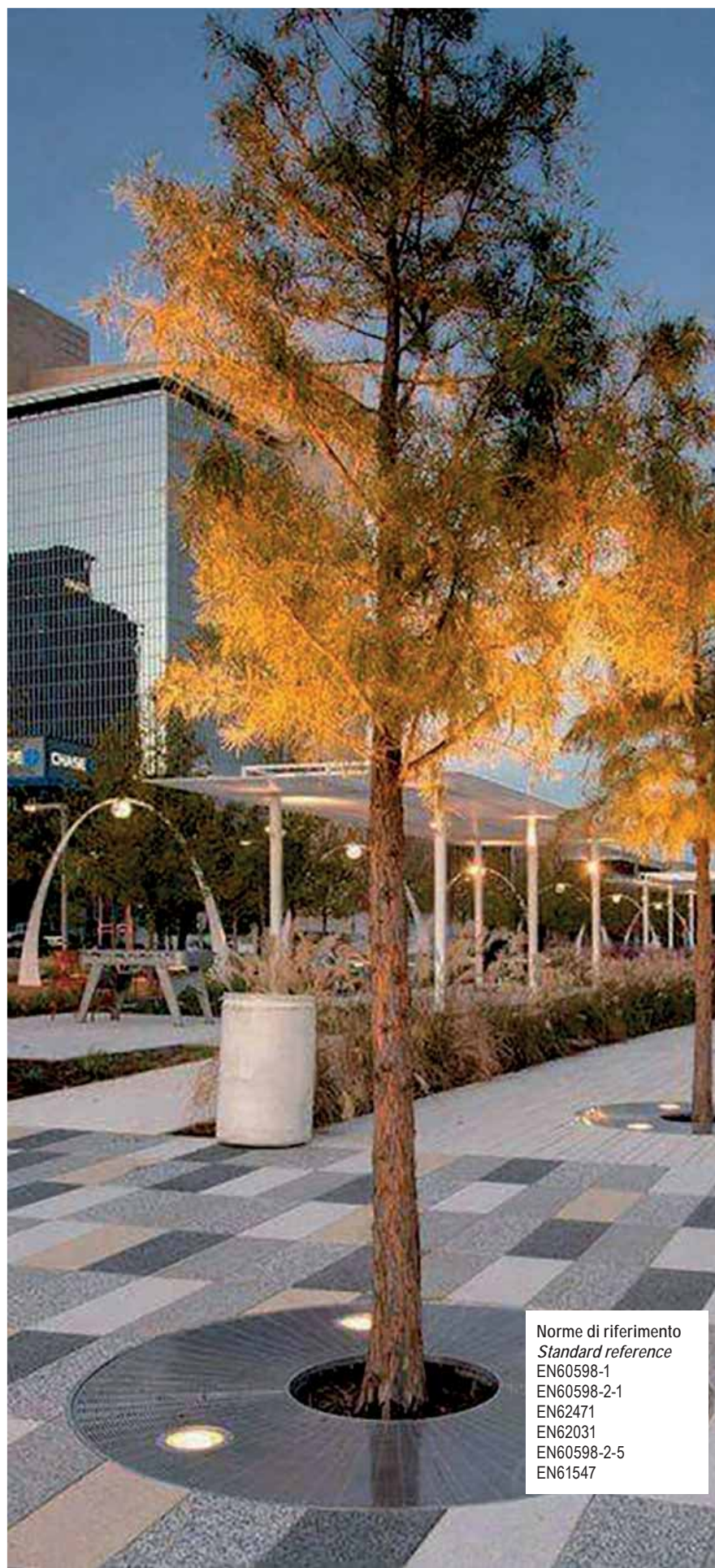

Norme di riferimento
Standard reference
EN60598-1
EN60598-2-1
EN62471
EN62031
EN60598-2-5
EN61547

LED Rondò e LED Naasby sono apparecchi da esterno, ad alto grado di protezione, utilizzabile sia tramite fissaggio che ad incasso ideale per giardini, parchi, aiuole, terrazzi, corselli per piscine.

Installazione: incassi a pavimento adatti per illuminare percorsi pedonali, aree verdi, porticati, edifici sia residenziali che pubblici.

Cassaforma: inclusa.

Corpo: in alluminio pressofuso. Verniciatura di tipo poliesteri eseguita a polvere resistente agli agenti atmosferici e alla nebbia salina. Ghiera e viterie in acciaio Inox AISI 316L.

Schermo: vetro temperato 4mm resistente agli shock termici e agli urti (LED Rondò), tecnopolimero (LED Naasby).

Guarnizioni: in gomma siliconica.

Sorgente: LED **SAMSUNG**

Driver: incluso (LED Rondò) escluso (LED Naasby).

LED Rondò and LED Naasby are a luminaire for outdoor use, with high protection degree, for fixed or recessed installation, for gardens, parks, flowerbeds, terraces, Pool lanes.

Installation: floor recessed luminaires suitable for illuminating pedestrian paths, green areas, porches, buildings either public or domestic.

Recessed housing: included.

Housing: die-cast aluminium body. Polyester powder coating. Resistance to atmospheric agents and corrosion guaranteed in saline mist. Closing ring and screws in stainless steel AISI 316L.

Shield: 4mm tempered glass resistant against thermal shocks and collisions (LED Rondò), technopolymer (LED Naasby).

Gaskets: made with silicone rubber.

*Source: LED **SAMSUNG***

Driver: included (LED Rondò), not included (LED Naasby)



Calpestabile e carrabile, fino a 10Km/h - 1000 Kg con pneumatici gonfiati ad aria. Non sostare.

Walkable and suitable for vehicles, up to 10Km/h - 1000Kg with tyres inflated with compressed air.

Do not stand.

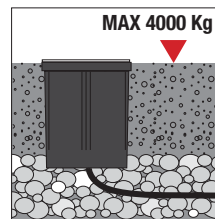

In caso di posa in muratura, la struttura muraria deve sostenere un carico di 4000 Kg. senza deformarsi. Il fondo della cassaforma è aperto, si rende necessario un fondo di ghiaia per il drenaggio.

In the event of masonry laying, the wall structure must withstand a load of 4000 Kg. without deforming. The bottom of the framework is open, it's necessary a gravel bottom for drainage.

LED Rondò - LED Naasby



LED Rondò

LED Naasby Q

LED Naasby R-SF

Recessed

LED Rondò

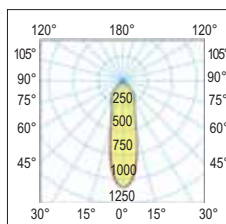

25°
Semi concentrante - Spot

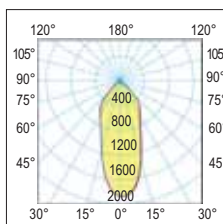

A richiesta - On demand
40°
Intermedio - Medium

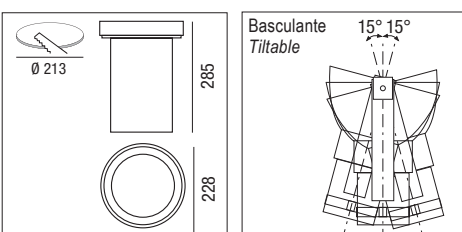
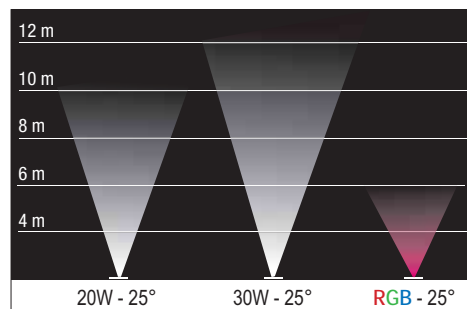

220-240 Vac	110 Vac a richiesta on demand	50/60 Hz	IP67	IK10	CRI >80	+40°C -20°C	CE	DRIVER INCLUDED RIPPLE FREE
850°	RG0	LOW FLICKER						

colour	Max W	angle	K	nominal lm tc = 25°C	lm output	lm/W	pcs	Kg	CELL
C	20	25°	4000	2.600	2.300	116	1	3,8	32567
C	20	25°	3000	2.600	2.300	116	1	3,8	32567-3K
C	30	25°	4000	3.900	3.480	116	1	3,8	32541
C	30	25°	3000	3.900	3.480	116	1	3,8	32540

A richiesta: per quantità disponibile con apertura di fascio a 40° - On demand: for quantity, available with 40° beam angle
A richiesta: per quantità minima 100 pezzi disponibili a 2700K - On demand: for quantity min 100 pcs available 2700K

Recessed



LED Naasby R

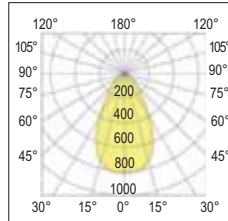

360°
Diffondente - Diffusing

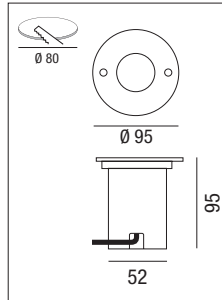

Cassaforma inclusa
Included recessed housing

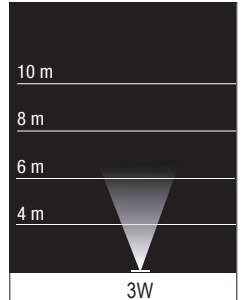

50/60 Hz IP67 IK09 CRI >80 +40°C / -20°C III CE DRIVER NOT INCLUDED 850°

colour	Max W	mA	angle*	K	nominal lm - tc = 25°C	lm output	lm/W	pcs	Kg	S+L
C	3	350	360°	4000	426	370	125	1	0,55	90.039/4K
C	3	350	360°	3000	426	370	125	1	0,55	90.039

* Fascio luminoso a luce diffusa - Diffused light beam

LED Naasby Q

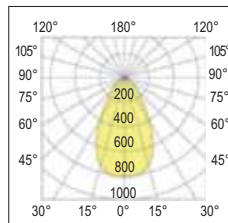

360°
Diffondente - Diffusing

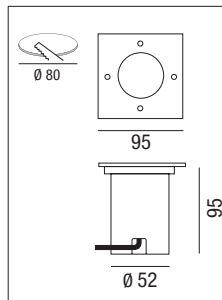

Cassaforma inclusa
Included recessed housing

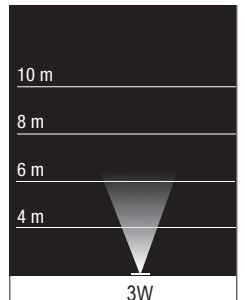

50/60 Hz IP67 IK09 CRI >80 +40°C / -20°C III CE DRIVER NOT INCLUDED 850°

colour	Max W	mA	angle*	K	nominal lm - tc = 25°C	lm output	lm/W	pcs	Kg	S+L
C	3	350	360°	4000	426	370	125	1	0,55	90.034/4K
C	3	350	360°	3000	426	370	125	1	0,55	90.034

* Fascio luminoso a luce diffusa - Diffused light beam



Recessed

LED Naasby

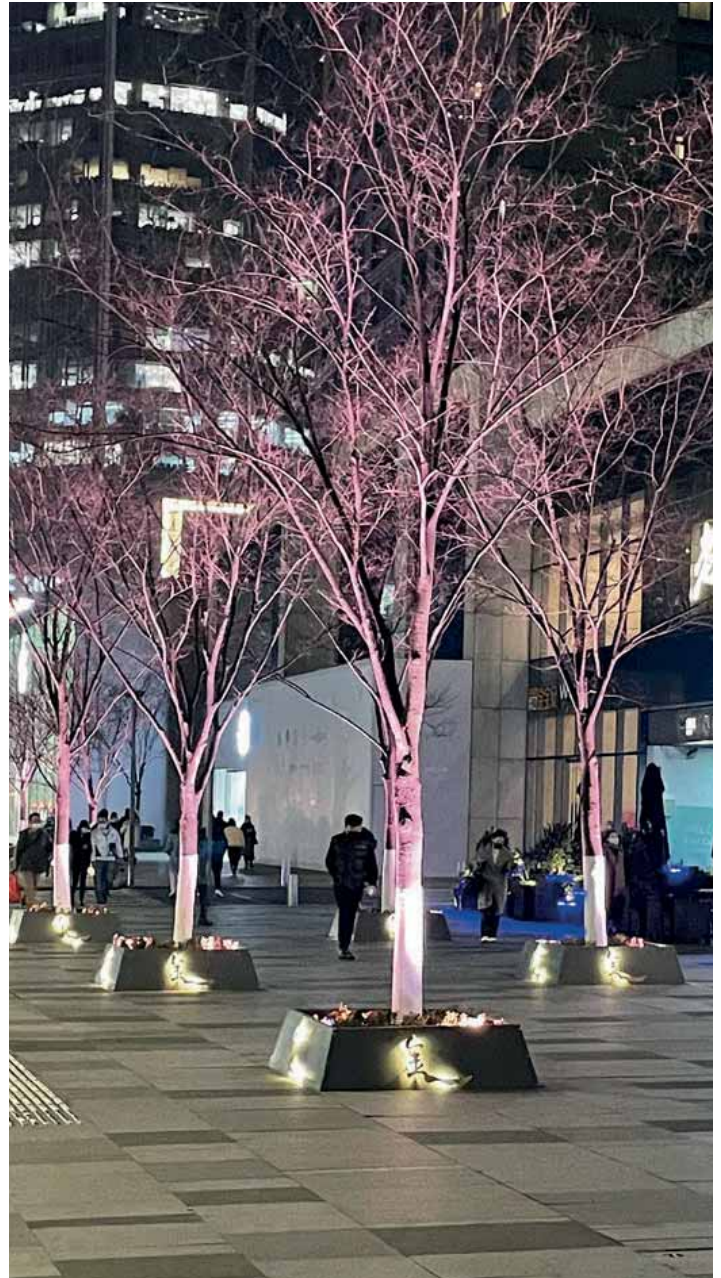

Recessed

Accessori non inclusi - Not included accessories



IP68

Cod. XYM20-3P - Accessorio IP68 per linee di luce continua
IP68 accessory for continuous light lines.



IP68

Cod. 12370
Big box - IP68
1 Entrata / 5 Uscite
1 Input / 5 Outputs



Esempi applicativi - application examples

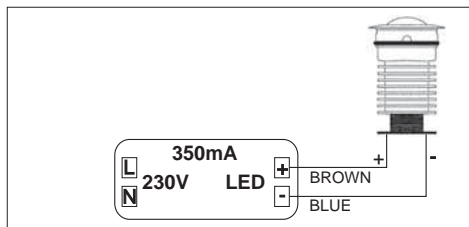

Dimensioni/Dimension

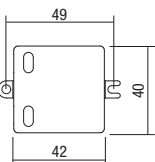

Cod. PTDC/3/350/N
3W

LED Driver per singola installazione
LED Driver for single installation

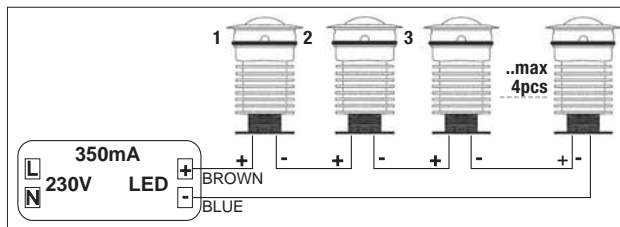

Dimensioni/Dimension

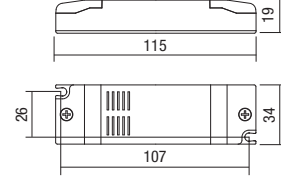

Cod. RN9150-2
Max 15W

LED Driver per collegamento in serie
LED Drivers for series connection

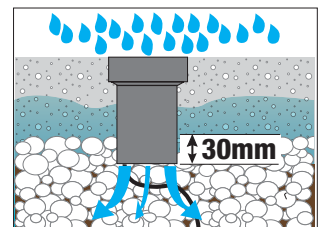

Al fine di permettere un adeguato drenaggio si consiglia di preparare un fondo di ghiaia in fase di installazione. Per il collegamento è necessario l'utilizzo di nastro agglomerante, tipo PE.

We advise you to prepare a gravel drain fund for installing the products, to ensure suitable drainage. The PE type agglomerating tape is required for the connection.

Illuminazione RGB - RGB lighting



Creare suggestive scenografie luminose in grado di valorizzare architetture importanti, ma anche di dare un valore estetico impensabile ad edifici anonimi. A queste possibilità offerte dalle luci colorate oggi si può aggiungere un elemento in più, ovvero quello del dinamismo. Il cambio di colore e di intensità della luce reso possibile dagli apparecchi di illuminazione RGB o RGBW diventa un vero e proprio cambio di scenari spettacolari. Questo tipo di soluzione si applica ai seguenti prodotti

Creating suggestive luminous scenographies able to enhance important architectures, but also to give an unthinkable aesthetic value to anonymous buildings. To these possibilities offered by colored lights today we can add an extra element, namely that of dynamism. The change of color and intensity of light made possible by RGB or RGBW lighting fixtures becomes a veritable cambio of spectacular scenarios.

This type of solution applies to the following products

LED Lince 68 Wall Washer RGBW



LED Lince 68 RGBW

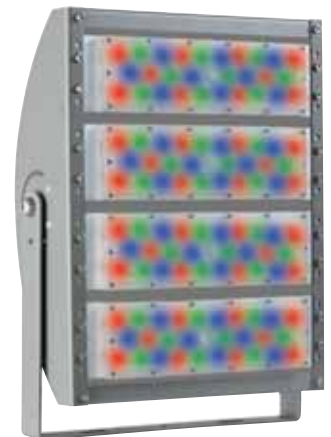

LED Lampo RGBW

LED Monza Round Wall Washer RGBW



LED Rondò RGB

LED Flex RGB



LED Gargano RGB

LED Monza round Wall Washer RGBW



Sistema LED lineare per applicazioni professionali nell'illuminazione di facciate, portici, sottopassaggi e in generale per l'illuminazione di particolari elementi architettonici. A richiesta è possibile collegare gli apparecchi in serie per ottenere delle linee di luce continua.

Installazione: su superfici verticali e orizzontali (completo di staffa di fissaggio).

Corpo: in policarbonato trasparente, resistente agli urti.

Testate di chiusura: in PVC, colore nero

Staffa di fissaggio: in alluminio, verniciata con polvere termoindurente poliesteri

Guarnizione: in gomma ai siliconi dalle rilevanti prestazioni meccaniche ed elastiche

Dispositivo anticondensa: valvola di compensazione e riciclo dell'aria

Norme di riferimento
EN60598-1; EN60598-2-1; EN62471; EN62031; EN61547

Sorgente: LED RGBW

Colori della luce ottenibili: tutta la banda cromatica delle radiazioni visibili compreso il **BIANCO**

Cablaggio: 1,5m cavo tipo H05RN-F 5x1mm² e connettore rapido 5 poli IP66 maschio/femmina per la connessione elettrica

LED linear system for professional lighting applications on facades, arcades, tunnels and generally to light up particular architectural elements. On demand it is possible to make a serial connection of the luminaires to have continuous light lines.

Installation: on vertical and horizontal surfaces (complete with fixing bracket)

Housing: made by transparent polycarbonate, resistant to collisions

End caps: made by PVC, black color

Fixing bracket: made by aluminum, coated with polyester thermoset powder

Gasket: made by silicone rubber with high mechanical and elastic performance

Anti-condensate device: valve for compensation and circulation of air

Standard reference
EN60598-1; EN60598-2-1; EN62471; EN62031; EN61547

Light source: RGBW LEDs

Achievable light colors: all the chromatic range of visible radiations WHITE included

Wiring: 1,5m cable type H05RN-F 5x1mm² and 5-pole IP66 male/female quick connector for the electrical connection

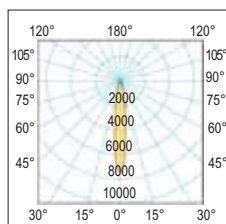

10°
Concentrante
Narrow
Schermo trasparente standard
Standard transparent shield

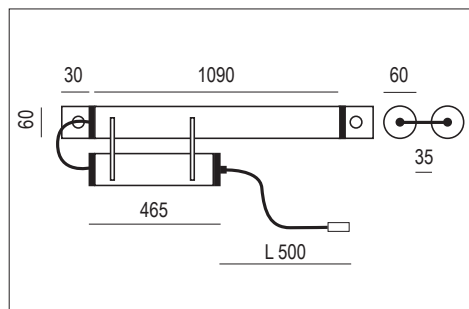
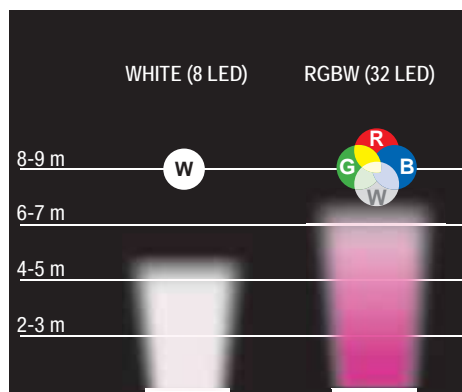

220-240 Vac	50/60 Hz	IP67	IK09	+40 C° -20	850°		
		CE	Driver included				

colour	W	angle	nominal lm tc = 25°C	lm output	lm/W	pcs	Kg	CELL
T	40	10°	2640	R = 360 - G = 650 - B = 240 W = 740 (6500K)	49	1	1,20	27393/RGB

Predisposto per cablaggio passante (vedi accessorio opzionale cod. XYM20-3P)
Set-up for through-wiring (see optional accessory code XYM20-3P).

LED Monza round Wall Washer RGBW

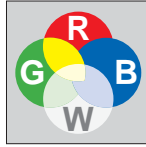

Questa tecnologia consente di ottenere un bianco puro oltre a tutte le gradazioni cromatiche, senza l'influenza dei colori RGB (vedi foto).

This technology makes it possible to achieve pure white in addition to every shade of colour, without the influence of RGB colours.



Cod. KE2
Controller DMX Driver (Pag. 209)



Connettore rapido
Rapid connection

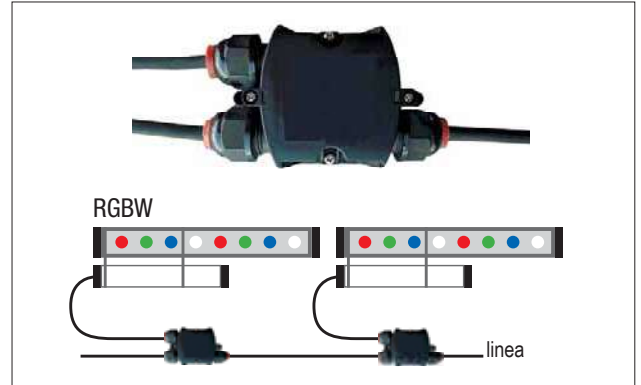

Cod. XYM20-3P - Accessorio IP68 per linee di luce continua
IP68 accessory for continuous light lines.



Completo di connettore IP68 per una rapida installazione
Complete with IP68 connector for quick installation

Schema di collegamento - *Wiring diagram*

KE2
DMX controller



LED Monza Round Wall Washer RGBW

LED Monza Round Wall Washer RGBW

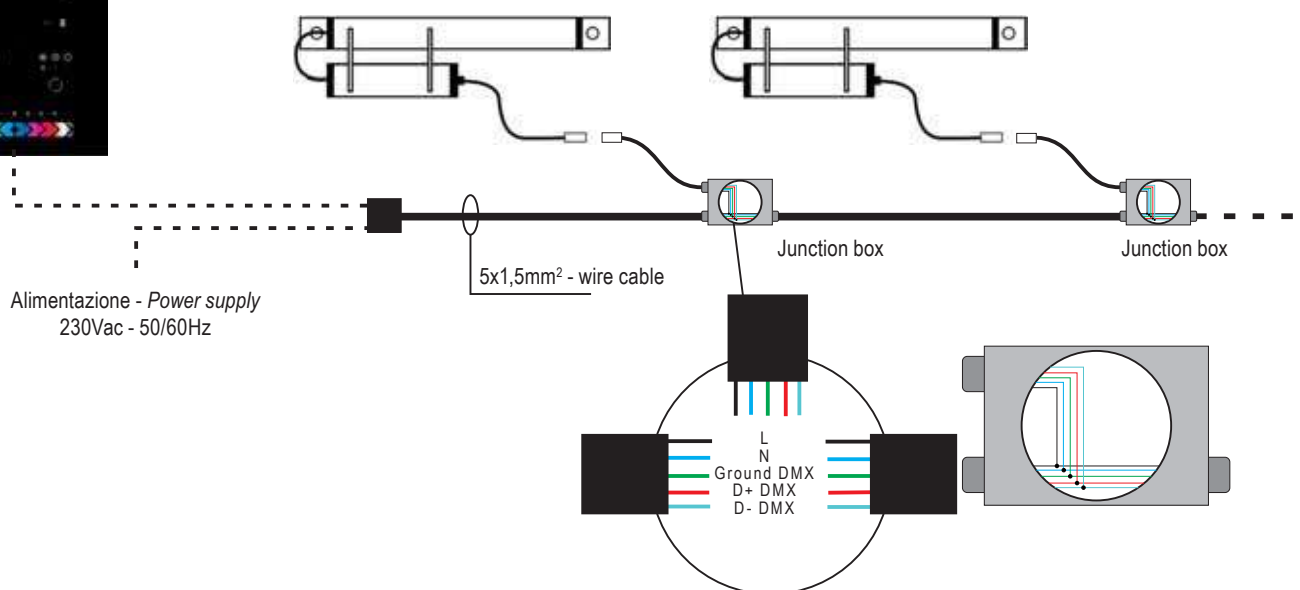

LED Rondò RGB



Apparecchio da esterno, ad alto grado di protezione, utilizzabile sia tramite fissaggio che ad incasso ideale per giardini, parchi, aiuole, terrazzi, corselli per piscine.

Installazione: incassi a pavimento adatti per illuminare percorsi pedonali, aree verdi, porticati, edifici sia residenziali che pubblici.

Cassaforma: inclusa.

Corpo: in alluminio pressofuso. Verniciatura di tipo poliestere eseguita a polvere resistente agli agenti atmosferici e alla nebbia salina. Ghiera e viterie in acciaio Inox AISI 316L.

Schermo: vetro temperato 4mm resistente agli shock termici e agli urti.

Guarnizioni: in gomma siliconica.

Norme di riferimento
EN60598-1; EN60598-2-1; EN62471;
EN62031; EN61547

Sorgente: LED COB 30W Full color

Driver: box esterno IP67 con driver e interfaccia controller DMX

Luminaire for outdoor use, with high protection degree, for fixed or recessed installation, for gardens, parks, flowerbeds, terraces, Pool lanes.

Installation: floor recessed luminaires suitable for illuminating pedestrian paths, green areas, porches, buildings either public or domestic.

Recessed housing: included.

Housing: die-cast aluminium body. Polyester powder coating. Resistance to atmospheric agents and corrosion guaranteed in saline mist. Closing ring and screws in stainless steel AISI 316L.

Shield: 4mm tempered glass resistant against thermal shocks and collisions.

Gaskets: made with silicone rubber.

Standard reference
EN60598-1; EN60598-2-1; EN62471;
EN62031; EN61547

Source: LED COB 30W Full color

Driver: IP67 external box with driver and DMX controller interface

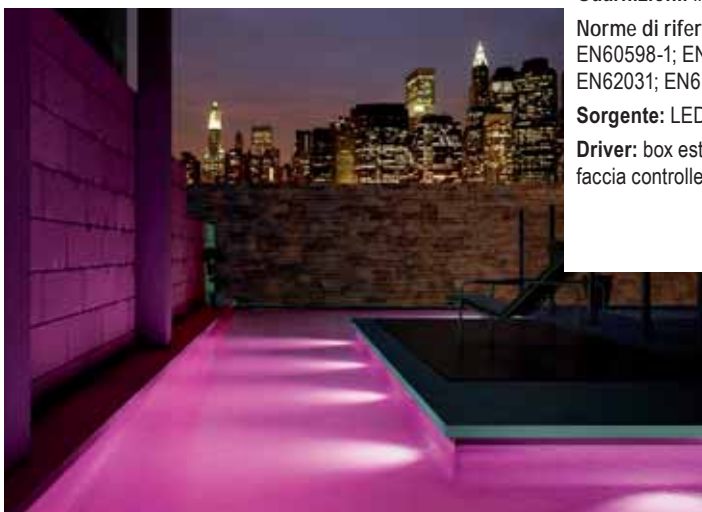

RGB

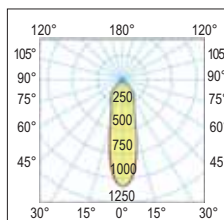
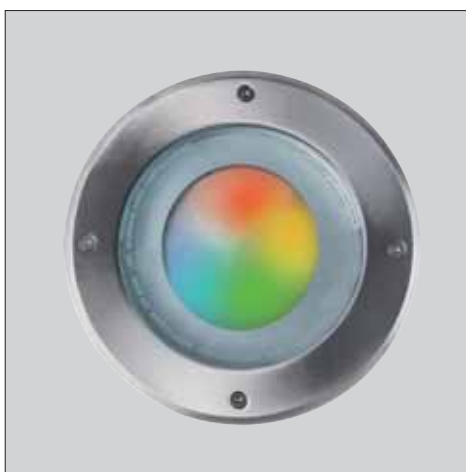

25°
Semi concentrante - Spot

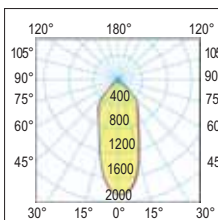

A richiesta - On demand
40°
Intermedio - Medium

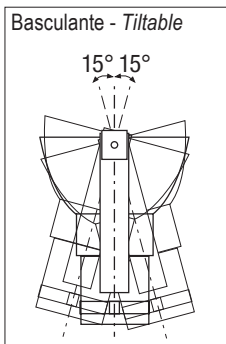
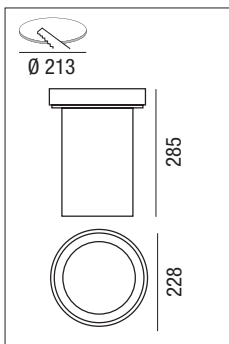
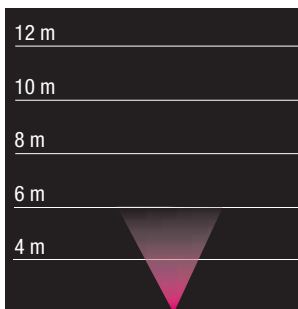

220-240
Vac

50/60
Hz

IP67

IK10

+40
C
-20

850

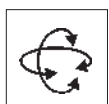
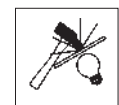

Driver included



colour	W	angle	K	nominal lm tc = 25°C	lm output	lm/W	pcs	Kg	CELL
C	30	25°	FULL COLOR		R = 145 - G = 320 B = 75	-	1	3,8	32567/RGB

LED Rondò RGB

Schema di collegamento - *Wiring diagram*

KE2
DMX controller



Alimentazione - *Power supply*
230Vac - 50/60Hz

LED Rondò RGB

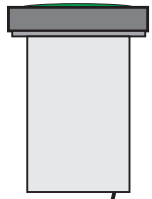

LED Rondò RGB

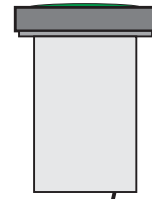

5x1,5mm² - wire cable

Junction box

Junction box

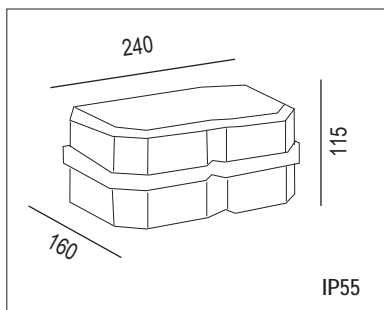
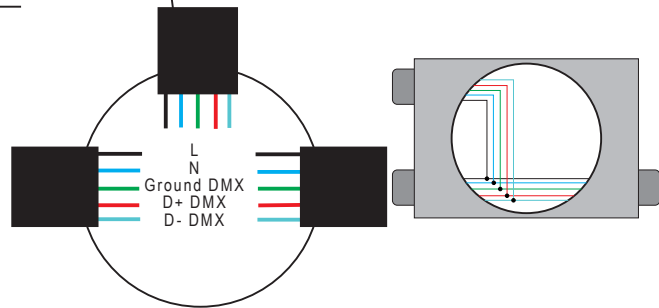

Gruppo di alimentazione esterno
all'apparecchio

Power supply group external to the luminaire

Basculante
Tiltable

Cod. KE2 - DMX controller (Pag. 209)

La centralina di controllo DMX è la soluzione perfetta per qualunque esigenza di controllo dell'illuminazione interna.

This complete stand alone wall-mounted DMX controller is the perfect answer to interior lighting control expectations.



MAX 1000 Kg

Calpestabile e carrabile, fino a 10Km/h - 1000 Kg con pneumatici gonfiati ad aria. Non sostare.

Walkable and suitable for vehicles, up to 10Km/h - 1000Kg with tyres inflated with compressed air. Do not stand.

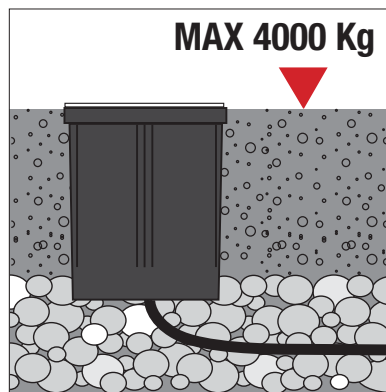

MAX 4000 Kg

In caso di posa in muratura, la struttura muraria deve sostenere un carico di 4000 Kg. Il fondo della cassaforma è aperto, si rende necessario un fondo di ghiaia per il drenaggio.

In the event of masonry laying, the wall structure must withstand a load of 4000 Kg. The bottom of the framework is open, it's necessary a gravel bottom for drainage.



LED Gargano RGB



Innovativi proiettori a LED per applicazioni professionali nell'illuminazione di facciate, portici, sottopassaggi e in generale per l'illuminazione di particolari elementi architettonici.

Installazione: su palo o parete/plafone (completo di staffa di fissaggio).

Corpo e telaio: in alluminio pressofuso UNI EN 1706 verniciato con polvere termoindurente poliestere.

Staffa di fissaggio: in acciaio, verniciata con polvere termoindurente poliestere, con goniometro graduato per un corretto puntamento del fascio luminoso.

Verniciatura: di tipo poliestere eseguita a polvere, resistente agli agenti atmosferici e alla corrosione. Colore Grigio RAL 9007.

Norme di riferimento

IEC 61000-4-5; EN60598-1; EN60598-2-1; EN62471; EN62031; EN60598-2-5; EN61547

Innovative LED projectors for professional lighting applications on facades, arcades, tunnels and generally to light up particular architectural elements.

Installation: on vertical and horizontal surfaces (complete with fixing bracket)

Housing and frame: made by UNI EN 1706 die-cast aluminum, coated with polyester thermoset powder.

Fixing bracket: made by stainless steel, coated with polyester thermoset powder, with graduated goniometer to allow the correct orientation of light beam

Coating: coated with powdered polyester, resistant to atmospheric agents and corrosion.

Grey colour RAL 9007

Standard reference

IEC 61000-4-5; EN60598-1; EN60598-2-1; EN62471; EN62031; EN60598-2-5; EN61547

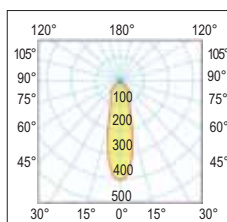

25°
Semi-concentrate - Spot

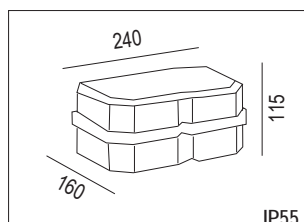

Cassetta stagna inclusa
Watertight box included



Cod. KE2 - DMX controller (Pag. 209)

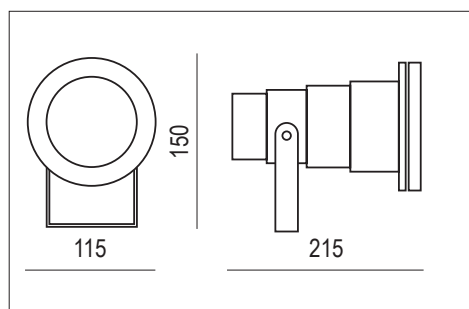

220-240 Vac	50/60 Hz	IP67	IK10	+40°C -20°C	850°		
		CE	Driver included				

colour	W	angle	LED	lm Output	pcs	Kg	CELL
G	9	25°	FULL COLOR	R = 135 - G = 195 - B = 90	1	0,80	24292
N	9	25°	FULL COLOR	R = 135 - G = 195 - B = 90	1	0,80	24293

LED Gargano RGB

Accessori non inclusi - Not included accessories



Frangiluce - Louver				
colour	Ø (mm)	pcs	Kg	S
N	150	1	1,00	24136
G	150	1	1,00	24137



Frangiluce - Louver				
colour	Ø (mm)	pcs	Kg	S
N	150	1	1,00	24138
G	150	1	1,00	24139



Cassaforma per installazione a pavimento Framework for floor installation				
colour	H (mm)	pcs	Kg	S
N	240	1	1,00	24134
G	240	1	1,00	24135



Cod. 24165
Picchetto in alluminio
Aluminium spike

Schema di collegamento con controller DMX - DMX controller wiring diagram

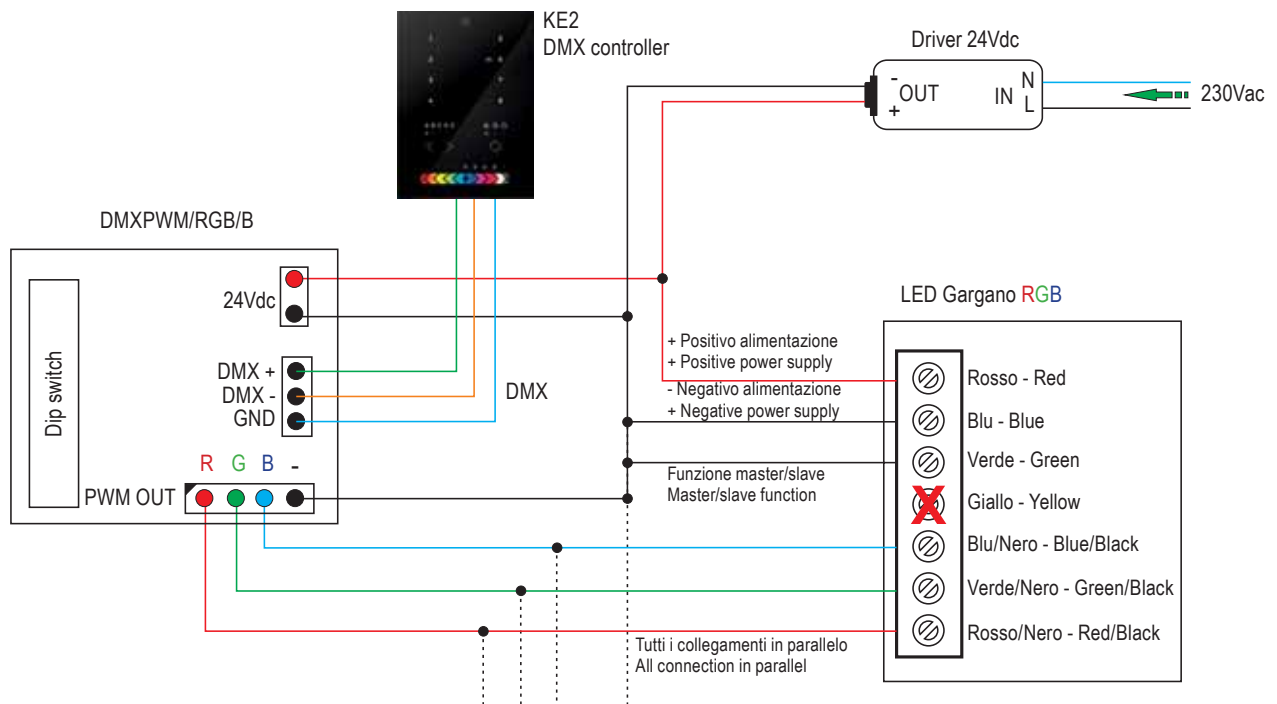

Schema di collegamento con comando a pulsante - Push button control wiring diagram

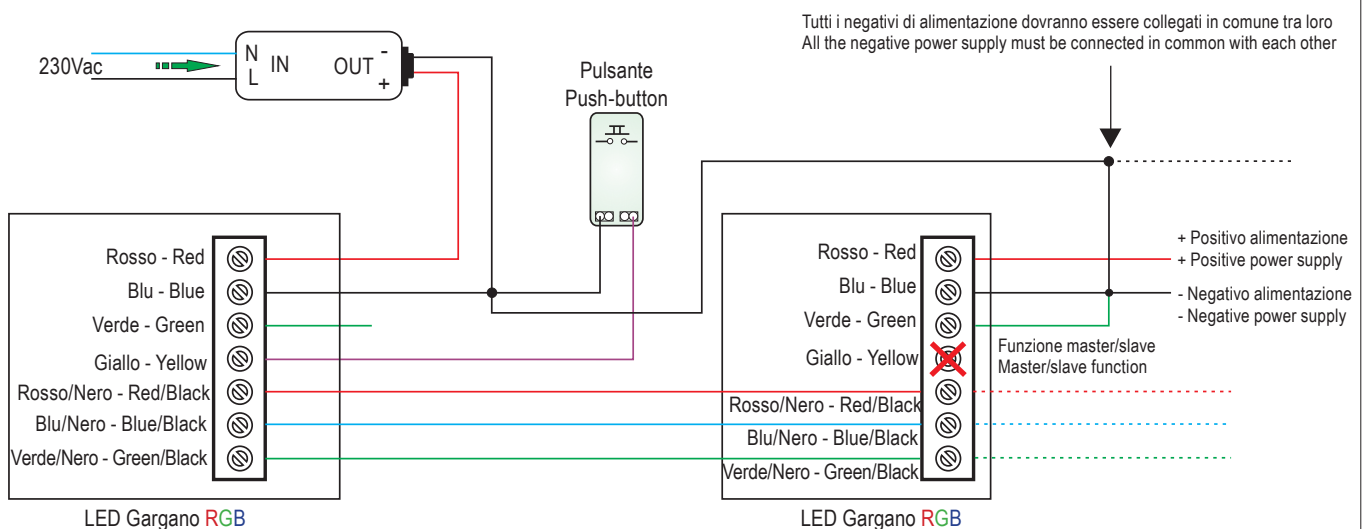

LED Flex RGB

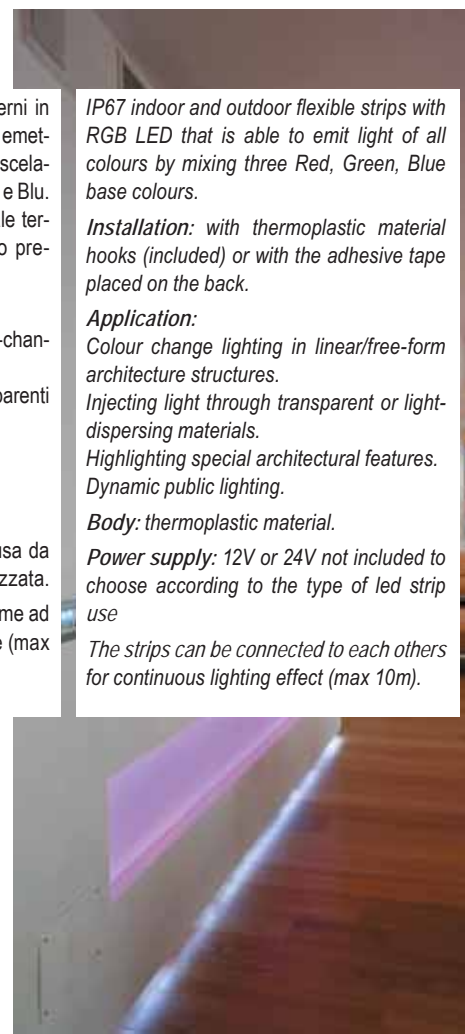
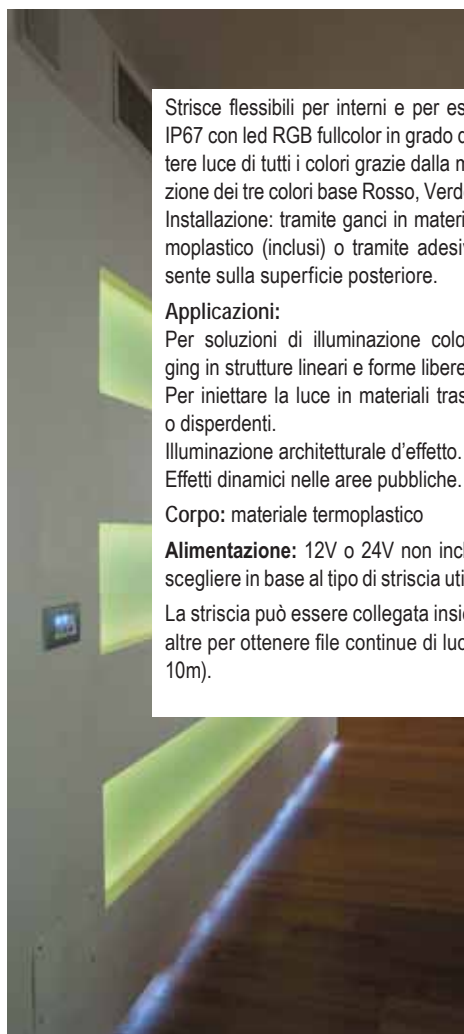

Strisce flessibili per interni e per esterni in IP67 con led RGB fullcolor in grado di emettere luce di tutti i colori grazie dalla miscelazione dei tre colori base Rosso, Verde e Blu. Installazione: tramite ganci in materiale termoplastico (inclusi) o tramite adesivo presente sulla superficie posteriore.

Applicazioni:

Per soluzioni di illuminazione color-changing in strutture lineari e forme libere. Per iniettare la luce in materiali trasparenti o disperdenti. Illuminazione architettonica d'effetto. Effetti dinamici nelle aree pubbliche.

Corpo: materiale termoplastico

Alimentazione: 12V o 24V non inclusa da scegliere in base al tipo di striscia utilizzata.

La striscia può essere collegata insieme ad altre per ottenere file continue di luce (max 10m).

IP67 indoor and outdoor flexible strips with RGB LED that is able to emit light of all colours by mixing three Red, Green, Blue base colours.

Installation: with thermoplastic material hooks (included) or with the adhesive tape placed on the back.

Application:

Colour change lighting in linear/free-form architecture structures. Injecting light through transparent or light-dispersing materials. Highlighting special architectural features. Dynamic public lighting.

Body: thermoplastic material.

Power supply: 12V or 24V not included to choose according to the type of led strip use

The strips can be connected to each others for continuous lighting effect (max 10m).



IP66

+40
C°
-20

850°

Driver NOT included



colour	W/m	Vdc	LED	lm/m	pcs	Kg	S+L
T	7,2	12	FULL COLOR	300	1	0,38	90.001/RGB
T	14,4	24	FULL COLOR	600	1	0,38	90.001/RGB24V



LED Flex RGB

Comando sincronizzato con pulsante isolato - *Synchronizd control with isolated button*

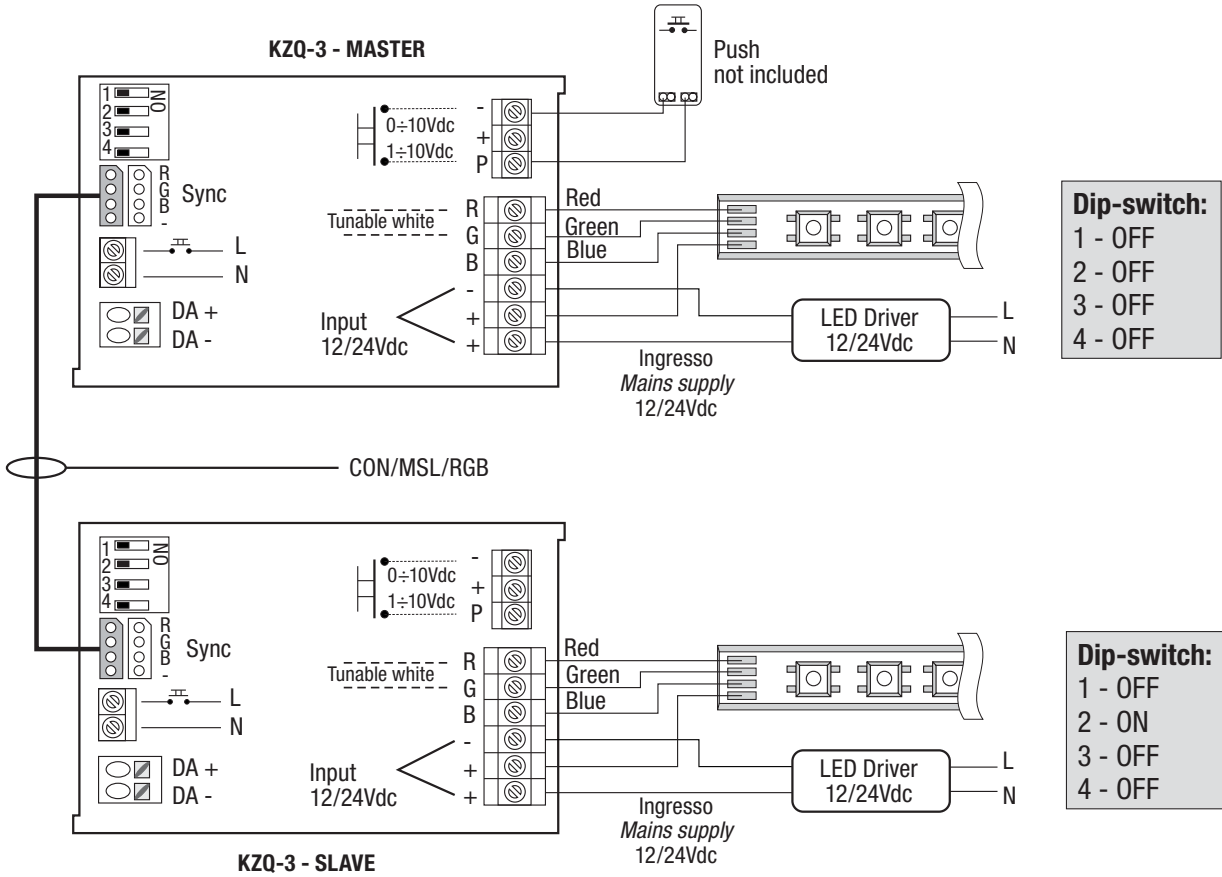

Esempio applicativo con centralina DMX - *Application example with DMX control uni*

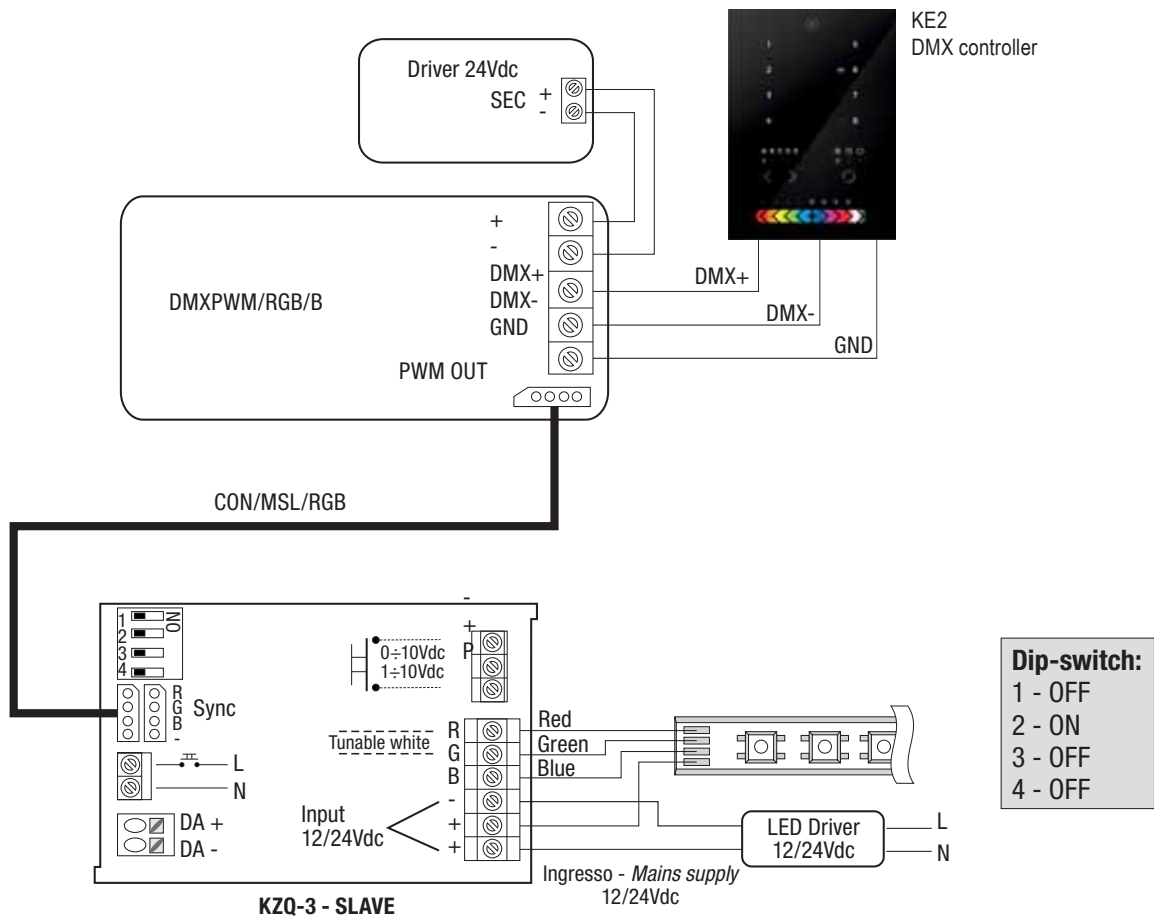

LED Lampo RGBW



Innovativi proiettori a LED di semplice installazione. Per applicazioni professionali nell'illuminazione di facciate, portici, sottopassaggi e in generale per l'illuminazione di particolari elementi architettonici.

Installazione: sospensione, parete/plafone e testa palo (completo di staffa di fissaggio).

Corpo: in alluminio estruso anodizzato.

Telaio: in acciaio verniciato con polvere termoindurente poliester.

Staffa di fissaggio: in acciaio, verniciata con polvere termoindurente poliester

Verniciatura: di tipo poliester eseguita a polvere, resistente agli agenti atmosferici e alla corrosione. Colore Grigio RAL 9007.

Optica: diffondente

Lenti: PMMA autoestinguenti antiurto

Protezione alle sovratensioni inclusa:

Modo differenziale 6kV (L-N)

Modo comune 10kV (L-GND, N-GND, L&N-GND)

LED Driver e Controller RGBW inclusi:

Conforme alla Norma: IEC 61000-4-5.

Fattore di potenza: $\geq 0,98$

Norme di riferimento

IEC 61000-4-5; EN 60598-1;

EN60598-2-1; EN62471; EN62031;

EN60598-2-5; EN61547

Innovative LED projectors that are easy to install. For professional lighting applications on facades, arcades, tunnels and generally to light up particular architectural elements.

Installation: on vertical and horizontal surfaces (complete with fixing bracket)

Housing: n anodized extruded aluminium.

Frame: in steel painted with thermosetting polyester powder.

Fixing bracket: made by stainless steel, coated with polyester thermoset powder.

Coating: coated with powdered polyester, resistant to atmospheric agents and corrosion. Grey colour RAL 9007

Optic: diffused

Lenses: self-extinguishing shockproof PMMA

Protection against overvoltages included:

Differential mode 6kV (L-N)

Standard mode 10kV (L - GND, N-GND, L&N-GND).

LED Driver and RGB controller:

Conforming to IEC 61000-4-5.

Power factor: $\geq 0,98$

Standard reference

IEC 61000-4-5; EN60598-1;

EN60598-2-1; EN62471; EN62031;

EN60598-2-5; EN61547

RGB

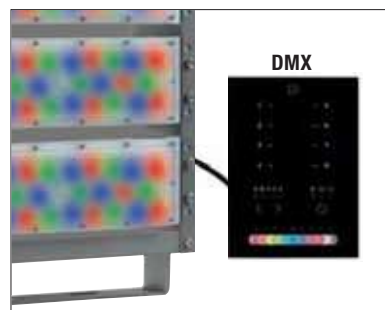
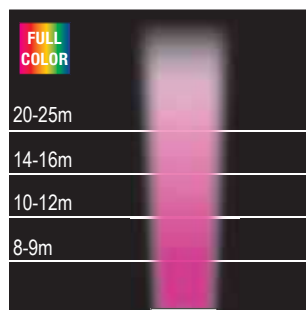
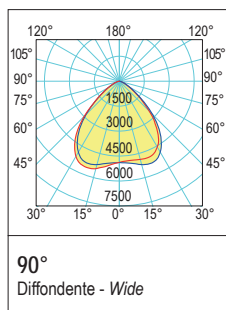
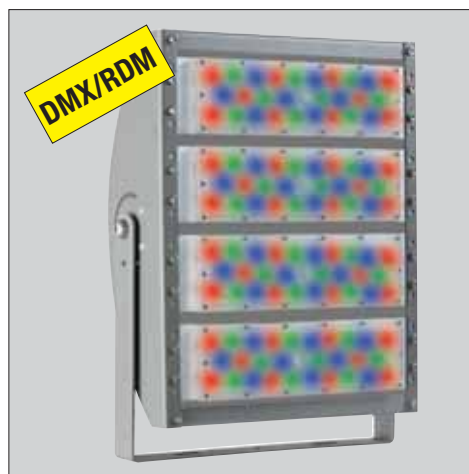

Lampo RGB 240W

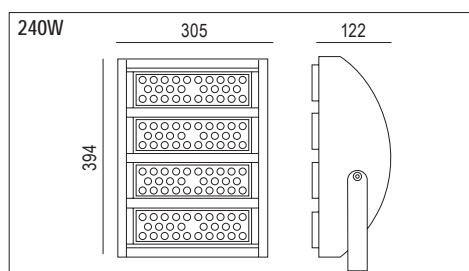
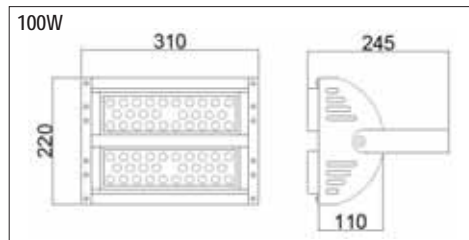

100-240 Vac	50/60 Hz	IP66	IK10	+40 C -40	850°		
		CE	Driver included				

colour	W	LED	angle	lm output	pcs	Kg	CELL
G	100	FULL COLOR	90°	R = 480 - G = 1000 - B = 400 W = 1800	1	2,90	RFL90-RGB
G	240	FULL COLOR	90°	R = 960 - G = 2000 - B = 800 W = 3600	1	5,40	RFL180-RGB

LED Lampo RGBW

Schema di collegamento - *Wiring diagram*

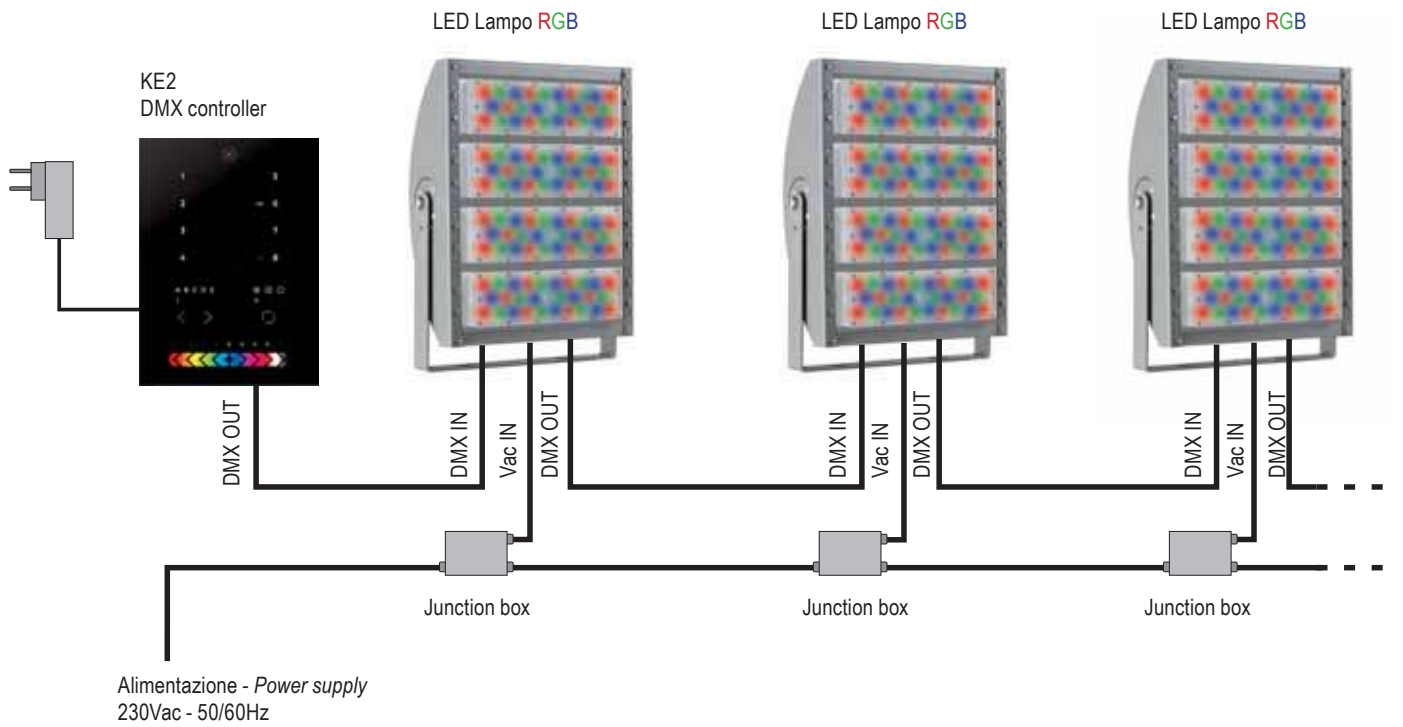

Cod. KE2 - DMX controller (Pag. 209)

La centralina di controllo DMX è la soluzione perfetta per qualunque esigenza di controllo dell'illuminazione interna.

This complete stand alone wall-mounted DMX controller is the perfect answer to interior lighting control expectations.

Ottiche a richiesta - Optics on demand

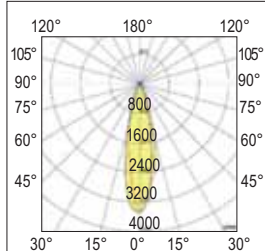

25°
Concentrante - *Spot*

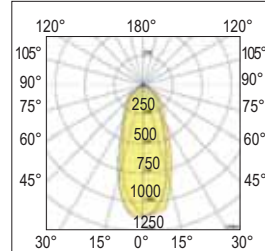

40°
Semi-diffondente - *Wide*

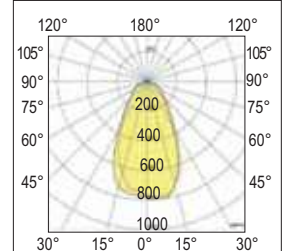

60°
Diffondente - *Flood*



Questa tecnologia consente di ottenere un bianco puro oltre a tutte le gradazioni cromatiche, senza l'influenza dei colori RGB (vedi foto).

This technology makes it possible to achieve pure white in addition to every shade of colour, without the influence of RGB colours.





Sistema LED per applicazioni professionali nell'illuminazione di facciate, portici, sottopassaggi e per l'illuminazione d'accento di particolari elementi architettonici. A richiesta è possibile collegare gli apparecchi anche in serie (LED Lince 68 Wall Washer RGBW).

Installazione: a terra o a parete (completo di staffa di fissaggio).

Corpo: Cornice in acciaio inox 304 resistente alla corrosione, nebbia salina e raggi UV

Schermo: vetro temperato.

Ottiche: realizzate in PMMA resistenti ai raggi UV.

Staffa di fissaggio: in acciaio Inox 304.

Guarnizione: in gomma ai siliconi dalle rilevanti prestazioni meccaniche ed elastiche.

Norme di riferimento: EN60598-1; EN60598-2-1; EN62471; EN62031; EN61547

Sorgente: LED RGBW

Colori della luce ottenibili: tutto lo spettro visivo compreso il **BIANCO**.

Equipaggiamento: completo di cavo e accessori.

Apparecchio in immersione: max 5 metri

LED system for professional applications in the lighting of facades, porches, subways and in general for accent lighting of particular architectural elements. On request it is possible to connect the fixtures in series to obtain continuous light lines (LED Lince 68 Wall Washer RGBW).

Installation: on the ground or on the wall (complete with fixing bracket).

Body: 304 stainless steel frame resistant to corrosion, salt spray and UV rays.

Shield: tempered glass.

Optics: made in PMMA resistant to UV radiation

Fixing bracket: in 304 stainless steel.

Gasket: silicone rubber with significant mechanical and elastic performance.

Reference standards: EN60598-1; EN60598-2-1; EN62471; EN62031; EN61547

Source: RGBW LED

Colors of light obtainable: the whole visual spectrum including **WHITE**.

Equipment: complete with cable and accessories.

Underwater lamp: max 5 meters



A richiesta - On demand

DMX controller



Pag. 209

LED Lince 68 RGBW

NEW

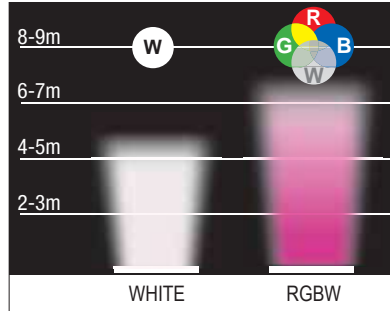
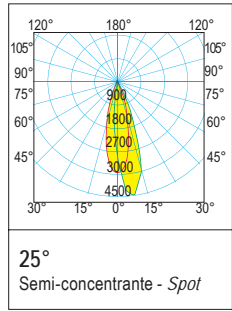

Questa tecnologia consente di ottenere un bianco puro oltre a tutte le gradazioni cromatiche, senza l'influenza dei colori RGB (vedi foto).
This technology makes it possible to achieve pure white in addition to every shade of colour, without the influence of RGB colours.

24Vdc IP68 IK08 +60°C/-25°C 850° Driver NOT included CE FULL COLOR

colour	W	angle	LED	lm -output	pcs	Kg	S+L
S	36	25°	FULL COLOR	R = 235 - G = 351 - B = 85 W = 380 (6500K)	001	1,440	RGBW16DMX

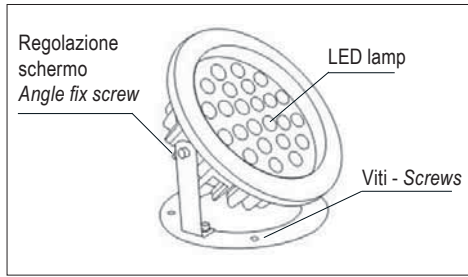
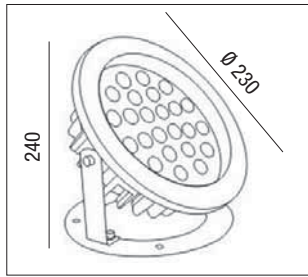

LED Lince 68 Wall Washer RGBW

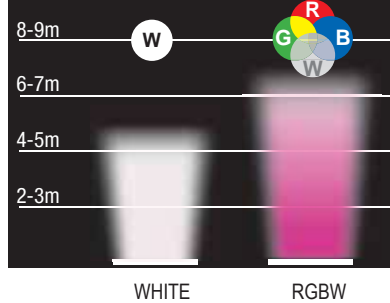
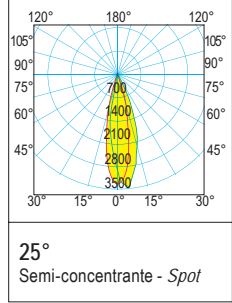

Questa tecnologia consente di ottenere un bianco puro oltre a tutte le gradazioni cromatiche, senza l'influenza dei colori RGB (vedi foto).
This technology makes it possible to achieve pure white in addition to every shade of colour, without the influence of RGB colours.

24Vdc IP68 IK08 +60°C/-25°C 850° Driver NOT included CE FULL COLOR

colour	W	angle	LED	lm -output	pcs	Kg	S+L
S	36	25°	FULL COLOR	R = 198 - G = 304 - B = 75 W = 335 (6500K)	001	1,440	RGBW18DMX

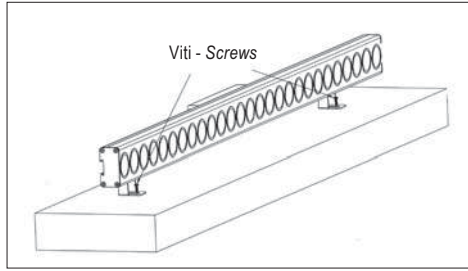
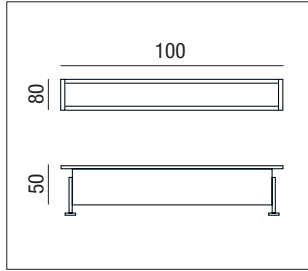

RGB

LED Lince 68 RGBW - Schema di collegamento - Wiring diagram

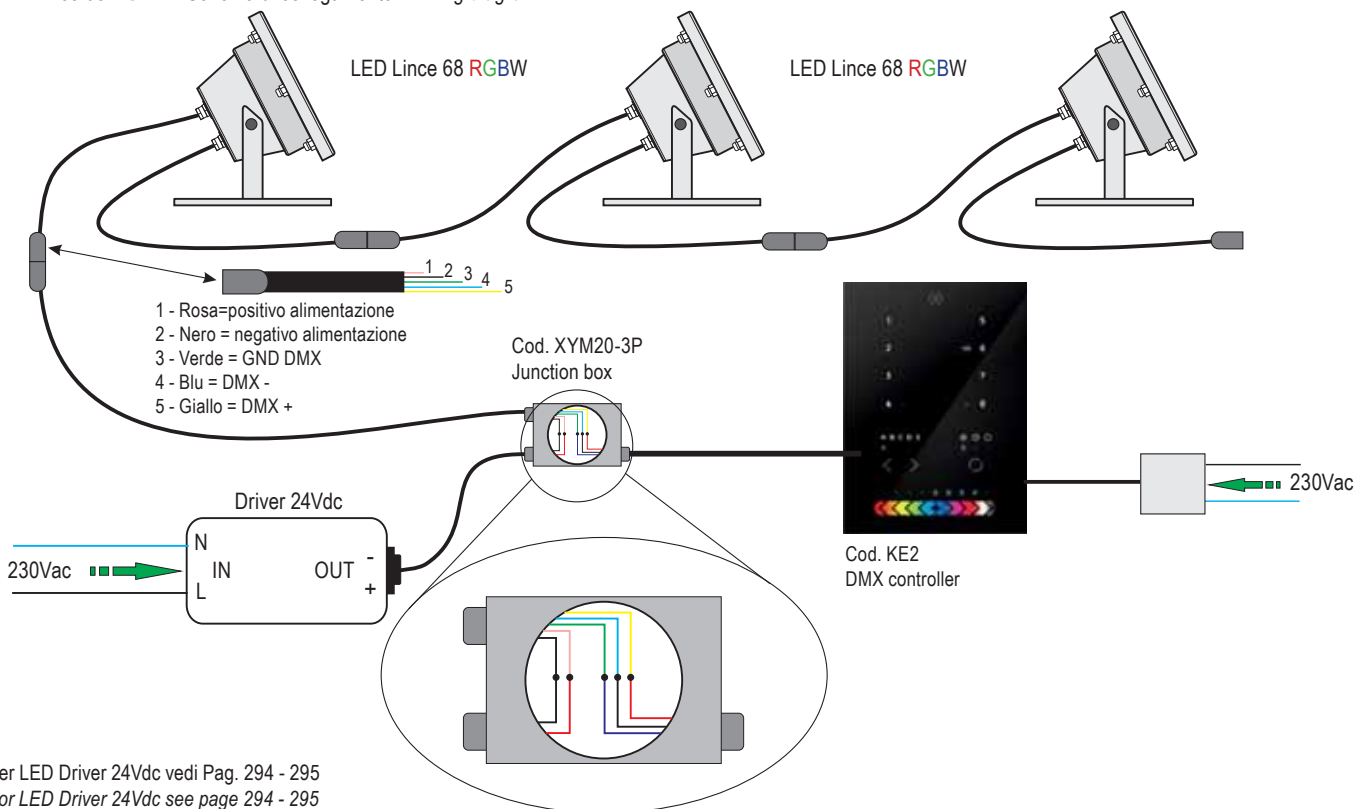

LED Lince 68 Wall Washer RGBW - Schema di collegamento - Wiring diagram

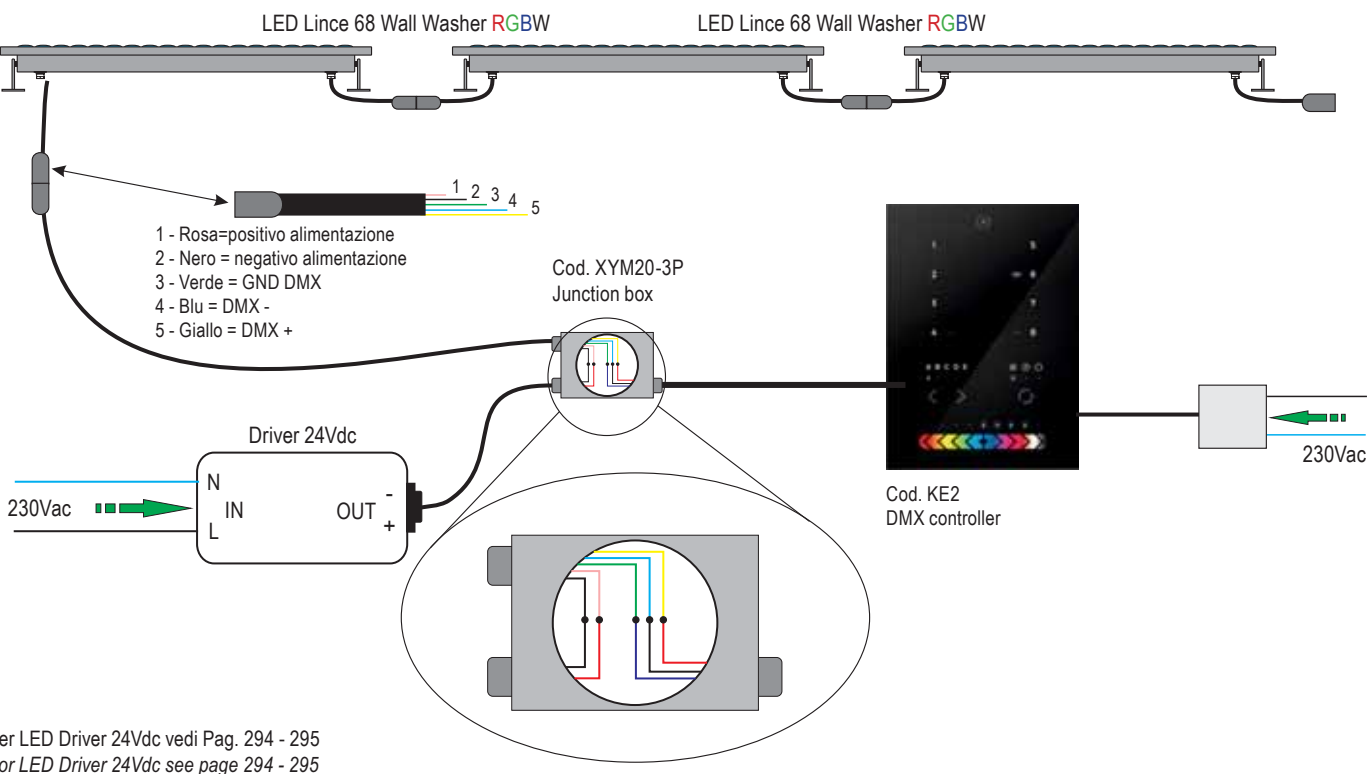

Accessori - Accessories



Cod. KE2

Centralina di controllo DMX utilizzabile in modalità stand alone
DMX control unit for use in stand alone mode

Altri modelli più economici sono acquistabili on-line
Cheaper models can be purchased online

Controller DMX programmabile in grado di funzionare in modalità stand alone. Selezione delle scene programmate tramite tastiera touch: pulsanti per la selezione dello scenario, regolazione luminosità, selezione colore, velocità scenografia, accensione/spegnimento.

- Compatibile con USITT DMX512A
- Connessione USB per programmazione
- Canali DMX 2x512
- Controllo touch panel
- Programmazione tramite pc
- Memoria esterna micro SD 512 Mb (fornita)
- Alimentatore per il funzionamento in modalità stand alone (fornito)

Programmable DMX controller capable of operating in stand alone mode. Selection of the programmed scenes via the touch keyboard: buttons for selecting the scenario, adjusting the brightness, selecting the color, setting speed, on / off.

- Compatible with USITT DMX512A
- USB connection for programming
- 2x512 DMX channels
- Touch panel control
- Programming via PC
- 512 Mb micro SD external memory (supplied)
- Power supply for stand alone operation (supplied)



Cod. DMXPWM/RGB/B

Interfaccia di connessione per FLEX LED RGB e LED GARGANO RGB
Interface for connection for FLEX LED RGB and LED GARGANO RGB

Il prodotto DMXPWM/RGB è un'interfaccia di connessione fra sistemi DMX e moduli slave per il controllo colore.

Ogni interfaccia DMXPWM/RGB usa 3 canali DMX per generare 3 segnali di controllo colore (Rosso - Verde - Blu), che vengono inviati al modulo Slave per il controllo colore.

L'interfaccia DMXPWM/RGB dispone di 10 Dip-Switches per impostare (in codice binario) l'indirizzo "X" del primo canale DMX usato dall'interfaccia

The DMXPWM/RGB product is an interface for connection between DMX systems and RGB slave dimmers.

Each DMXPWM/RGB interface uses 3 DMX channels to generate 3 colour (Red, Green and Blue) control signals, which are sent to RGB slave dimmer.

The DMXPWM/RGB interface has got 10 Dip-Switches to set the "X" adress of the first DMX channel used by interface.



KZQ-1 - Cod. 30928

Controller per FLEX LED RGB
FLEX LED RGB controller

Controller RGB per uso indipendente con comando a pulsante incorporato da abbinare agli alimentatori Miniled.

Potenza: 30W - V out: 12Vdc - V in: 12Vdc

Il passaggio da un programma all'altro avviene premendo il pulsante ed è evidenziato da un diverso segnale acustico tipo beep. Il pulsante di comando è integrato nel regolatore ed è in grado di gestire tre differenti programmi luminosi

- 1) Un colore monocromatico a luce fissa (1 Beep)
- 2) Cambio dei colori di tipo passo-passo (2 Beeps)
- 3) Cambio dei colori di tipo ciclico FULL COLOR (3 Beeps)
- 4) Spegnimento (4 Beeps).

RGB controller for independent use with incorporated push-button control to be continued with Mini-led feeders.

Potenza: 30W - V out: 12Vdc - V in: 12Vdc

The passage from one program to another occurs by different beep-type acoustic signal.

The control button is integrated in the regulator, and is able to manage three different lighting programs.

- 1) A monochromatic colour with steady light (1 Beep)
- 2) Step-by-step colour change (2 Beeps)
- 3) Cyclical FULL COLOR change (3 Beeps)
- 4) Turn off (4 Beeps).

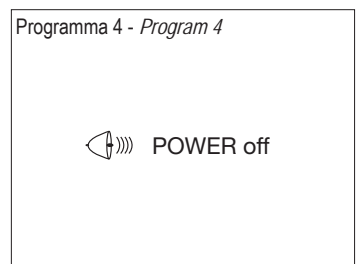
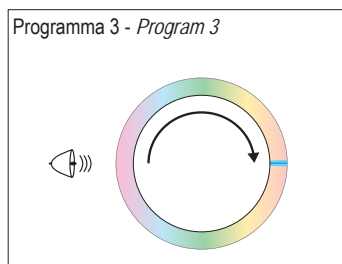
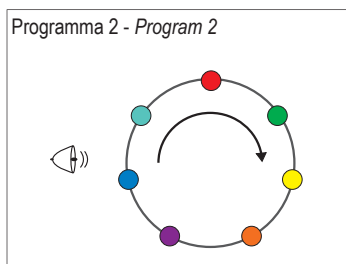
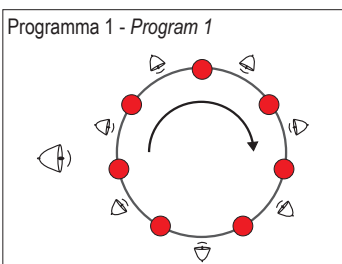

Accessori - Accessories



Cod. KE2
 Centralina di controllo DMX utilizzabile in modalità stand alone.
 Nel prezzo di questo codice non è inclusa la programmazione
DMX control unit for use in stand alone mode.
Programming is not included in the price of this code
Altri modelli più economici sono acquistabili on-line
Cheaper models can be purchased online

Controller DMX programmabile in grado di funzionare in modalità stand alone. Selezione delle scene programmate tramite tastiera touch: pulsanti per la selezione dello scenario, **regolazione luminosità, selezione colore, velocità scenografia, accensione/spegnimento.**

- Compatibile con USITT DMX512A
- Connessione USB per programmazione
- Canali DMX 2x512
- Controllo touch panel
- Programmazione tramite pc
- Memoria esterna micro SD 512 Mb (fornita)
- Alimentatore per il funzionamento in modalità stand alone (fornito)

Programmable DMX controller capable of operating in stand alone mode. Selection of the programmed scenes via the touch keyboard: buttons for selecting the scenario, adjusting the brightness, selecting the color, setting speed, on / off.

- *Compatible with USITT DMX512A*
- *USB connection for programming*
- *2x512 DMX channels*
- *Touch panel control*
- *Programming via PC*
- *512 Mb micro SD external memory (supplied)*
- *Power supply for stand alone operation (supplied)*



Cod. DMXPWM/RGB/B
 Interfaccia di connessione per **FLEX LED RGB e LED GARGANO RGB**
Interface for connection for FLEX LED RGB and LED GARGANO RGB

Il prodotto DMXPWM/RGB è un'interfaccia di connessione fra sistemi DMX e moduli slave per il controllo colore.

Ogni interfaccia DMXPWM/RGB usa 3 canali DMX per generare 3 segnali di controllo colore (Rosso - Verde - Blu), che vengono inviati al modulo Slave per il controllo colore. L'interfaccia DMXPWM/RGB dispone di 10 Dip-Switches per impostare (in codice binario) l'indirizzo "X" del primo canale DMX usato dall'interfaccia

The DMXPWM/RGB product is an interface for connection between DMX systems and RGB slave dimmers.

Each DMXPWM/RGB interface uses 3 DMX channels to generate 3 colour (Red, Green and Blue) control signals, which are sent to RGB slave dimmer.

The DMXPWM/RGB interface has got 10 Dip-Switches to set the "X" adress of the first DMX channel used by interface.



KZQ-1 - Cod. 30928
 Controller per **FLEX LED RGB**
FLEX LED RGB controller

Controller RGB per uso indipendente con comando a pulsante incorporato da abbinare agli alimentatori Miniled.

Potenza: 30W - V out: 12Vdc - V in: 12Vdc

Il passaggio da un programma all'altro avviene premendo il pulsante ed è evidenziato da un diverso segnale acustico tipo beep. Il pulsante di comando è integrato nel regolatore ed è in grado di gestire tre differenti programmi luminosi

- 1) Un colore monocromatico a luce fissa (1 Beep)
- 2) Cambio dei colori di tipo passo-passo (2 Beeps)
- 3) Cambio dei colori di tipo ciclico FULL COLOR (3 Beeps)
- 4) Spegnimento (4 Beeps).

RGB controller for independent use with incorporated push-button control to be continued with Mini-led feeders.

Potenza: 30W - V out: 12Vdc - V in: 12Vdc

The passage from one program to another occurs by different beep-type acoustic signal.

The control button is integrated in the regulator, and is able to manage three different lighting programs.

- 1) *A monochromatic colour with steady light (1 Beep)*
- 2) *Step-by-step colour change (2 Beeps)*
- 3) *Cyclical FULL COLOR change (3 Beeps)*
- 4) *Turn off (4 Beeps).*

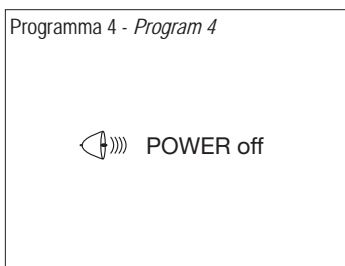
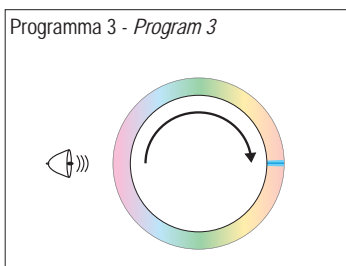
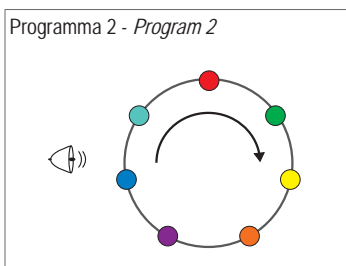
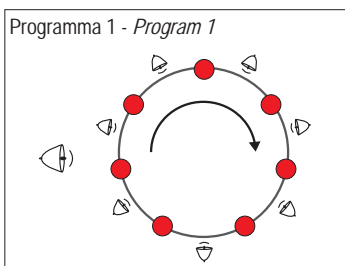

Condizioni Generali di vendita - *General sales conditions*

Il presente listino sostituisce ed annulla tutte le precedenti edizioni. *This price list replaces and cancels all previous editions.*

Condizioni generali

Spedizione Italia:

Per poter ottenere il portofranco è necessario effettuare un ordine di almeno Euro 1.500 (unica consegna), diversamente il cliente avrà un addebito in fattura del 3%. Importo minimo fatturabile Euro 300.

La merce sarà evasa nel rispetto della quantità di cubetto o relativi multipli. Per eventuali richieste di disimballo sarà applicato un sovrapprezzo del 10%.

Imballo cartone

Gratis. La merce viaggia a rischio e pericolo del committente. Trascorsi 8 giorni dal ricevimento merce non si accettano contestazioni.

Pagamento

Per i nuovi clienti ad avviso di merce pronta; per i clienti abituali trascorsi termini di pagamento concordati verranno addebitati gli interessi di mora. Foro competente Milano.

Resi

Prima di effettuare un reso è necessario richiedere e ottenere, a mezzo mail/fax, l'autorizzazione del nostro ufficio commerciale o del nostro agente di zona per concordarne le modalità. I resi inviati in porto assegnato e/o senza autorizzazione saranno respinti. Le riparazioni/sostituzioni vengono evase non prima di 30 giorni.

Quando il regolatore svolge funzioni vitali nell'impianto sarà necessario prevedere un'adeguata scorta o riserva fredda.

Non si effettuano sostituzioni anticipate.

Nel caso di errori di spedizione o di ordine, il prodotto deve essere reso imballato come all'origine.

Assicurazione RCP (responsabilità civile prodotti)

I prodotti Relco S.r.l. sono marcati e in molti casi Omologati IMQ, VDE, ENEC ecc. per il dettaglio delle omologazioni vedi pagine interne. Tutti i prodotti Relco S.r.l. sono inoltre coperti da una speciale polizza RCP valida in tutto il mondo stipulata con una tra le più prestigiose compagnie di assicurazione.

RELCO S.r.l., persegue una politica di continua ricerca e sviluppo, quindi si riserva di variare in qualsiasi momento e senza preavviso le caratteristiche dei prodotti illustrati. Le informazioni di questo catalogo svolgono un'azione esclusivamente informativa, ed essendo soggette a continue variazioni, non devono essere prese come un impegno da parte di Relco S.r.l.

Relco S.r.l. non si assume alcuna responsabilità per eventuali errori che si possono riscontrare nel presente catalogo. Nessuna parte di questo stampato può essere riprodotto, memorizzato, archiviato o trasmesso in qualsiasi forma o con qualsiasi mezzo elettronico, meccanico o altro, senza previa autorizzazione scritta di Relco S.r.l.

General conditions

Ex works minimum invoice charge € 2,500 (single delivery), otherwise the customer will be charged 3% on the invoice.

Minimum invoice charge 500 euros.

The goods will be processed according to cube-based amounts or relative multiples. A 10% charge will be applied on any unpacking requests.

Cardboard packaging

Free. Goods travel at the risk and peril of the client. Complaints must be submitted no later than 8 days after receipt of the goods.

Payment

On being informed that the goods are ready (for new clients); after the agreed deadline for the payment default, interest will be charged (for regular clients).

Any disputes shall be settled by the court of Milan.

Returns

Before returning any goods, you need to request and obtain authorisation via email/fax from our sales office or our local representative to agree on how they will be returned. Goods sent on a carriage forward basis and/or without authorisation will be rejected. Repairs/replacements will not be processed for 30 days.

Provide for an adequate stock or cold reserve when the dimmer performs essential functions in the system.

We do not provide replacements in advance.

In case of shipping or order errors, the product must be returned in its original packaging.

RCP insurance (civil liability on products)

Relco S.r.l. products are marked and in many cases type approved IMQ, VDE, ENEC, etc. Please see internal pages for details on type-approval. Moreover, all Relco S.r.l. products are covered by a special RCP insurance policy with one of the top insurance companies, which is valid in any country worldwide.

RELCO S.r.l. pursues a policy of continuous research and development and therefore reserves the right to change the characteristics of the products without prior warning. The information in this catalogue is only meant for informative purposes and is subject to constant changes, which means that it must not be considered as a commitment on behalf of Relco S.r.l.

Relco S.r.l. shall not be liable for any errors reported in this catalogue. No part of this publication can be reproduced, saved, filed or transmitted under any form and by any electronic, mechanical or any other kind of means without the prior permission in writing of Relco S.r.l.

Termini e condizioni di garanzia - *Warranty terms and conditions*

La garanzia è applicabile solo quando:

1. I prodotti sono installati, utilizzati e mantenuti in conformità alle specifiche tecniche indicate nella marcatura del prodotto (con riferimento specifico al voltaggio e alla temperatura di funzionamento), alle istruzioni fornite insieme al prodotto e alle norme vigenti.
2. L'installazione e la manutenzione sono eseguite da personale tecnico qualificato.
3. Il difetto segnalato pregiudica il funzionamento del prodotto.
4. Il prodotto non è stato in alcun modo modificato, alterato o trattato con agenti chimici o in qualsiasi altra maniera, senza previa autorizzazione scritta di Relco S.r.l.
5. Il prodotto oggetto della garanzia è messo a disposizione di Relco S.r.l. per ulteriori analisi tecniche e per il tempo necessario al suo svolgimento.
6. Il difetto deve essere denunciato per iscritto a Relco S.r.l. entro 30 (trenta) giorni dalla data del ricevimento dei prodotti (in caso di difetti apparenti) o dalla scoperta del difetto (in caso di difetti occulti).
7. La garanzia ha effetto immediato dalla data di acquisto e farà fede la data della fattura di vendita.
8. Periodi di garanzia superiori a 24 mesi potranno essere richiesti dall'acquirente e verranno accordati dopo aver valutato le condizioni di applicazione specifiche.

Nel caso in cui il difetto venga riconosciuto, Relco S.r.l. sceglierà, a sua discrezione, se riparare o sostituire il prodotto con lo stesso prodotto o con prodotti equivalenti, tenendo in considerazione l'evoluzione tecnica dei prodotti e dei loro componenti.

Qualsiasi intervento tecnico o sostituzione (parziale o completa) del prodotto effettuato in garanzia non darà comunque diritto a prolungamenti o rinnovi della stessa oltre i 24 mesi anni dalla data della fornitura, in quanto la relazione legale tra le parti non è rinnovata.

La riparazione o la sostituzione del Prodotto, non include costi o spese per la rimozione o reinstallazione. Relco S.r.l. non rimborserà alcuna perdita consequenziale subita a causa di un prodotto difettoso, come ad esempio costi di spedizione, costi di assemblaggio, costi di installazione in loco, perdita di profitto, costi complessivi degli acquirenti.

Esclusioni e limitazioni

La presente garanzia non include:

- A. I costi e le spese della manodopera, costi e spese delle attrezzature magazzino e qualsiasi altro costo extra relativo e/o risultante da qualsiasi lavoro necessario per riparare il difetto (es. costi/spese del montaggio e smontaggio, trasporto degli apparecchi difettosi, da riparare e nuovi prodotti) saranno a carico del cliente.
- B. I componenti elettrici soggetti ad usura che sono assimilabili a materiale di consumo (ad esempio, batterie).
- C. I prodotti realizzati su specifica richiesta del cliente e da lui approvati.
- D. Danni al prodotto dovuti a negligenza, al trasporto o ad eventuali imprevisti e di prevedibili situazioni che non rientrano nelle normali condizioni di utilizzo di cui al punto 1 (ad esempio scariche elettriche e fulmini);

La presente garanzia speciale non si applica se l'apparecchio non è usato per lo scopo per cui è stato realizzato;

La presente garanzia non garantisce l'integrità della verniciatura quando il prodotto viene utilizzato in un ambiente salino o in presenza di agenti corrosivi. In nessun caso Relco S.r.l. sarà responsabile per danni accidentali, compensativi, consequenziali, indiretti, speciali o altri danni.

La responsabilità di Relco S.r.l. per un difetto del prodotto sarà in ogni caso limitata alla somma pagata per quel prodotto difettoso.

Il decadimento del flusso è un fenomeno previsto durante la vita del LED e è quindi non protetto da garanzia.

Controversie Tecniche

In caso di controversia tecnica le parti sottoporranno il prodotto in contestazione a perizia di Esperto Terzo nominato di comune accordo o, in mancanza di accordo, dal Presidente del Tribunale di Milano.

La valutazione dell'esperto sarà vincolante per entrambe le Parti.

Le spese verranno sostenute dalle Parti in misura del 50% ciascuna.

The conventional warranty applies only when:

1. The products are installed, used and maintained in accordance with the technical specifications reported on the product's marking (with specific reference to the operating voltage and temperature), with the instructions provided with the product and with current standards.
2. Installation and maintenance are carried out by qualified technical personnel.
3. The reported defect affects the operation of the products.
4. The product has not been in any way modified, altered or treated with chemicals or in any other way without the prior written consent of Relco S.r.l.
5. The product covered by the warranty is made available by Relco S.r.l. for further technical analyses and for the time required to conduct them.
6. The defect must be notified in writing to Relco S.r.l. within 30 (thirty) days from the date of receipt of the goods (in case of visible defects) or from the discovery of the defect (in case of hidden defects).
7. The warranty has immediate effect from the purchase date, the invoice date serving as proof;
8. Warranty periods exceeding 24 months may be requested by the Purchaser and will be agreed after assessing the specific application conditions.

In case of the defect is acknowledged by Relco S.r.l., the latter will choose at its discretion whether to repair or replace the product with the same product or with equivalent products, by taking into account the technical evolution of the products and of their components.

Any technical intervention or replacement (partial or complete) of the product made during the period covered by the warranty will not provide entitlement to extensions or renewals thereof beyond 24 months from the date of supply, as the legal relationship between the parties has not been renewed.

The repair or replacement of the product does not include costs or expenses for removal or reinstallation. Relco S.r.l. shall not be held liable and therefore shall not refund any consequential loss suffered as a result of a defective product, such as costs and shipping, assembly costs, on-site installation costs, loss of profit, the total costs of the buyers.

Exclusions and limitations

This commercial warranty does not include:

- A. Costs and expenses for labour, equipment/warehouse costs and expenses and any other extra cost relating to and/or resulting from any work needed to repair the defect (e.g. costs and expenses for assembly disassembly, transportation of defective appliances to be repaired and new products will be held by the customer);
- B. Electrical components subject to wear that are considered wear material (e.g. batteries, etc.)
- C. Products manufactured based on specific customer request, and approved by him;
- D. Damage to the product due to negligence, transport, unforeseen and unforeseeable events that do not fall under the normal conditions of use of 1 (such as electric shocks and lightning).

This special warranty does not apply if the appliance is not used for the purpose it was manufactured for;

This warranty does not guarantee the paintwork will remain intact when the product is used in a saline environment or in the presence of corrosive agents. RelcoS.r.l. will not, under any circumstances, be responsible for accidental, compensatory, consequential, indirect, special or other kind of damage. The responsibility for Relco S.r.l. for a product defect will be in any case limited to the amount paid for that defective product.

The depreciation of the flow is a phenomenon expected during the life of the LED and is therefore not protected by warranty.

Technical disputes

In the event of a technical dispute, the parties will have the product examined by a third-expert appointed by mutual agreement or, if no agreement is reached, by the president of the Court of Milan.

The evaluation of the expert will be binding for both parties.

Each party will cover 50% of the expenses.

RELCO Group Italia



RELCO S.r.l.
Via delle Azalee, 6/A
20090 Buccinasco - Milano
Italy
Tel. +39 02 488616.1 r.a.
relcogroup.com

• RELCO Group Germany GmbH
Hilden/Düsseldorf, Deutschland

• RELCO Group Italia
Buccinasco - Milano

• RELCO SUD
Santa Ninfa, Trapani

RELCO Lighting Middle East
Dubai (UAE)

RELCO Sud sito produttivo



RELCO SUD S.r.l.
Zona industriale lotti 19/20
91020 Santa Ninfa, Trapani
Italy
Tel. +39 0924 60330
Fax +39 0924 62388
e-mail: relcosud@gmail.com

RELCO Group Germany GmbH



Agnes - Pockels - Str. 9
40721 - Hilden/Düsseldorf
Deutschland
Tel. +49 (0) 2103 9119 5
Fax +49 (0) 2103 9119 69
e-mail: info@relcogroup.de

RELCO Lighting Middle East



Tel. +971 (0) 4 568 19 31
e-mail: ahmed.az@relcogroup.com
e-mail: joseph.pisati@relcogroup.com

light
MIDDLE EAST
intelligent building
MIDDLE EAST
17 - 19 January 2023
World Trade Center
Dubai, UA E

