

tromilux





Índice

4	INFORMAÇÃO TÉCNICA
9	INTERIOR
10	Perfis
67	Tubulares
77	Luminárias Estanques e Industriais
84	Luminárias Circulares e Donuts
97	Luminárias Lineares
106	Luminárias Suspensas
112	Projetores e Calhas
121	Espelhos de Luz
126	Saídas de Emergência
129	Focos Redondos
140	Focos Quadrados
163	Focos Salientes de Teto
175	Apliques de Parede
181	EXTERIOR
182	Luminárias de Encastrar no Teto
185	Luminárias Salientes de Teto
189	Luminárias de Encastrar de Parede
201	Luminárias Salientes de Parede
214	Luminárias de Encastrar no Piso
230	Luminárias Salientes de Piso
243	ACESSÓRIOS
244	ESQUEMA ELÉTRICO
246	ÍNDICE NUMÉRICO

Informação Técnica

Informação Normativa

 A ostentação da marca CE indica que o equipamento está em conformidade com as diretivas europeias para material elétrico de certos limites de tensão.

 **Classe I** Equipamento no qual a proteção contra choque elétrico não depende apenas do isolamento principal. Todas as partes ativas estão ligadas a um circuito terra de proteção.

 **Classe II** Equipamento no qual a proteção contra choque elétrico não depende apenas do isolamento principal. Inclui isolamento duplo ou reforçado.

 **Classe III** Equipamento no qual a proteção contra choque elétrico depende da alimentação a partir de uma tensão baixa de segurança.

 Esta luminária não pode ser coberta com material isolante ou análogo.

Índice de Proteção Mecânica

 **IK03** Proteção contra objeto sólido de 0.2kg lançado de uma altura de 140mm. Energia de choque 0,35 (J).

 **IK05** Proteção contra objeto sólido de 0.25kg lançado de uma altura de 280mm. Energia de choque 0,7 (J).

 **IK06** Proteção contra objeto sólido de 0.25kg lançado de uma altura de 400mm. Energia de choque 1 (J).

 **IK07** Proteção contra objeto sólido de 0.5kg lançado de uma altura de 400mm. Energia de choque 2 (J).

 **IK08** Proteção contra objeto sólido de 1,7kg lançado de uma altura de 300mm. Energia de choque 5 (J).

 **IK10** Proteção contra objeto sólido de 5kg lançado de uma altura de 400mm. Energia de choque 20 (J).

Gama de Produto

 **HF** Balastro eletrônico

 Balastro eletrônico de alta frequência com regulação de fluxo digital ou analógica

 Balastro eletrônico de alta frequência com regulação de fluxo digital ou analógica

 Kit de emergência

 **LED** Diodo emissor de luz

Índice de Proteção

 **IP20** Proteção contra corpos sólidos de diâmetro superior a 12mm. Sem proteção contra líquidos.

 **IP40** Proteção contra corpos sólidos de diâmetro superior a 1mm. Sem proteção contra líquidos.

 **IP43** Proteção contra corpos sólidos de diâmetro superior a 1mm. Protegido contra a queda de gotas de água com ângulo máximo de 60°.

 **IP44** Proteção contra corpos sólidos de diâmetro superior a 1mm. Protegido contra projeção de água.

 **IP54** Proteção contra corpos sólidos de diâmetro inferior a 1mm. Protegido contra projeção de água.

 **IP55** Proteção contra corpos sólidos de diâmetro inferior a 1mm. Protegido contra jatos de água.

 **IP65** Totalmente estanque a poeiras. Protegido contra jatos de água.

 **IP66** Totalmente estanque a poeiras. Protegido contra fortes jatos de água (força das ondas do mar).

 **IP67** Totalmente estanque a poeiras. Protegido contra efeitos de imersão (máx. 1m).

Tensão de Funcionamento

Tipo de Furação para Aplicação Encastrada

12V 24V

Tensão de alimentação da luminária



Forma e tamanho do corte para encastramento da luminária

230 V
50 Hz

Tensão de alimentação e frequência de funcionamento da luminária



Forma e tamanho do corte para encastramento da luminária

Leitura do Código

4540.121.10L

1

2

3

4

5

1 Referência do produto

2 Distingue especificidades do produto, como comprimento, potência e lumens

3 * Tipo de acabamento

4 ** Tipo de difusor

5 *** L - Com lâmpada / X - Sem lâmpada

* Os acabamentos disponíveis para cada produto estão descritos em rodapé na página correspondente ou abaixo da tabela do produto em questão. Para criar o código coloque o número correspondente ao acabamento pretendido no dígito 3 do código em exemplo.

** Os tipos de difusores disponíveis para cada produto estão descritos em rodapé na página correspondente ou abaixo da tabela do produto em questão. Para criar o código coloque a letra correspondente ao difusor pretendido no dígito 4 do código em exemplo.

*** Quando o produto é fornecido com lâmpada, substitua a letra L pelo número de cor de LED (Kelvin) desejada.

NOTA

Quando existe na referência um ou mais x minúsculos significa que o código está em aberto para ser completado.









Cores e Acabamentos

1 Branco (RAL 9016)	O Opalino
2 Cinza (RAL 9006)	P Prismático
3 Cinza Satinado (anodizado)	A Alumínio
4 Escovado (anodizado)	C Calha Trifásica
5 Ouro Velho (RAL 1036)	L 3R
6 Dourado (Tromilux)	B Black
7 Grafite (RAL 7016)	N Capa Técnica
8 Aço Inoxidável	T Transparente
9 Preto (RAL 9005)	F Fosco
0 RAL sob consulta	M Multifacetado
	E Espelho

Cor do LED





2 2700K
3 3000K
4 4000K
5 5000K
6 6000K
7 6500K

Saídas de Luz

 Uma saída de luz Projeção descendente	 Uma saída de luz Projeção frontal ou lateral	 Duas saídas de luz Projeção descendente e ascendente
 Uma saída de luz Projeção ascendente	 Uma saída de luz Projeção interior	 Três saídas de luz Projeção descendente, ascendente e frontal ou lateral
 Uma saída de luz Projeção orientável	 Uma saída de luz Projeção exterior	 Quatro saídas de luz Projeção lateral

Tipologia







Encastrar

	Aplicação de encastrar com aba Projeção de luz descendente
	Aplicação de encastrar sem aba Projeção de luz descendente
	Projector de calha trifásica de encastrar Projeção de luz orientável
	Calha trifásica de encastrar com aba

Sancas

	Sancas Projeção de luz indireta
--	-----------------------------------

Saliente

	Aplicação saliente Projeção de luz descendente
	Aplicação saliente Projeção de luz exterior
	Aplicação saliente Projeção de luz interior
	Aplicação saliente Projeção de luz 300° ou 360°
	Projector de calha Projeção de luz orientável
	Projector saliente Projeção de luz orientável
	Calha trifásica saliente

Suspensa

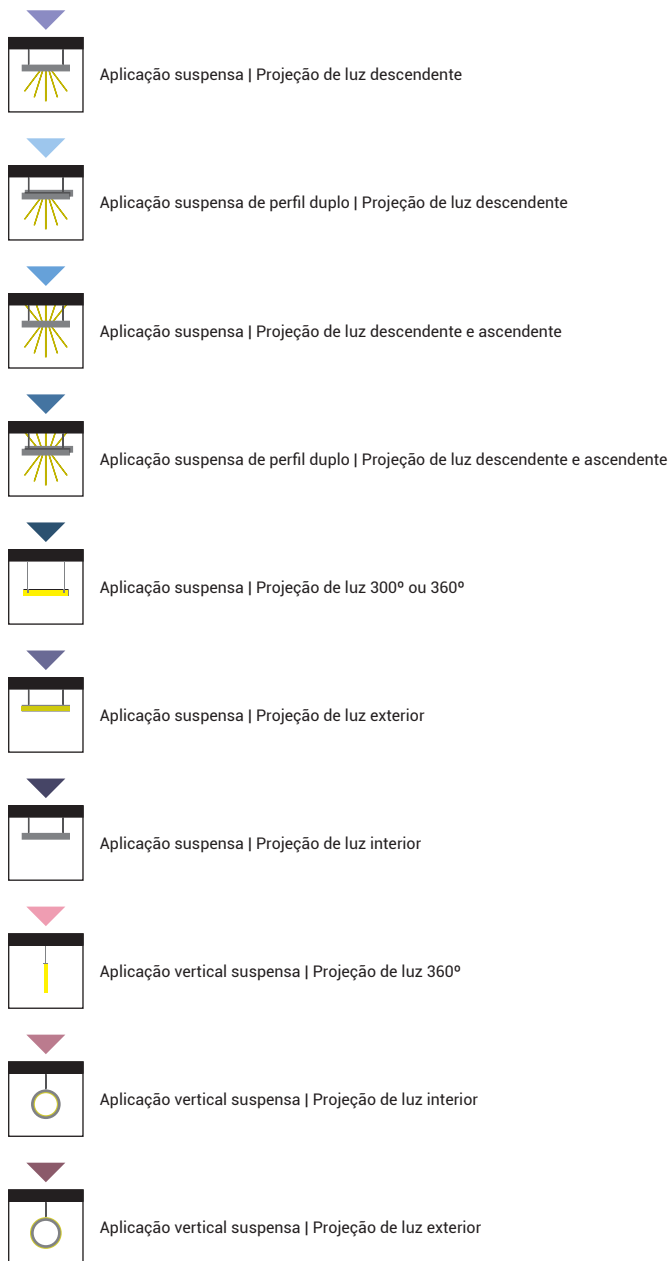

Piso

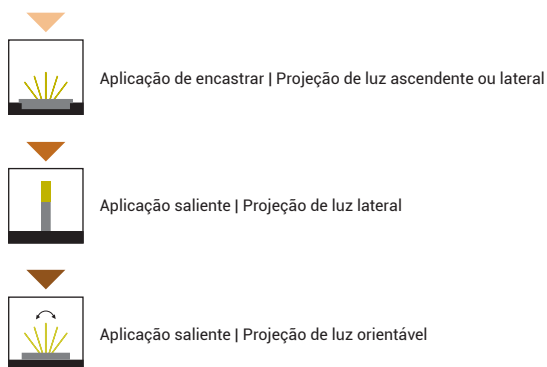

Parede

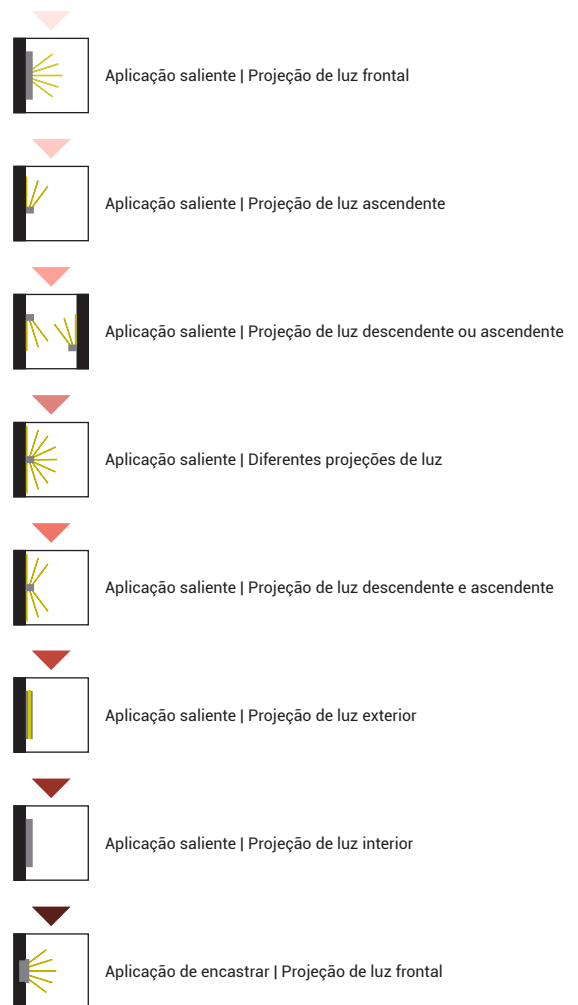

Tipologia





INTERIOR



Perfis

Perfis de encastrar com aba, projeção de luz descendente

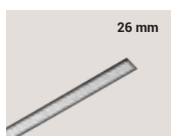

4530 | 4531 Pg. 12



4036 Pg. 14

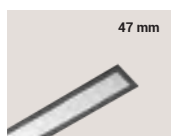

4031 Pg. 16

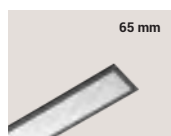

4032 Pg. 18



4033 Pg. 19

Perfis de encastrar sem aba, projeção de luz descendente

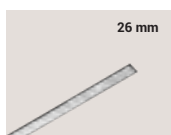

4524 | 4525 Pg. 20



4526 Pg. 22



4026 Pg. 24



4027 Pg. 26



4025 Pg. 27

Perfis salientes, projeção de luz descendente

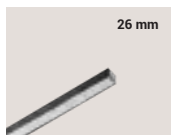

4540 | 4541 Pg. 28



4046 Pg. 30



4041 Pg. 32



4042 Pg. 34



4043 Pg. 35

Perfis suspensos, projeção de luz descendente

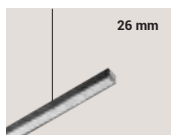

4550 | 4551 Pg. 36

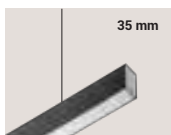

4556 Pg. 38

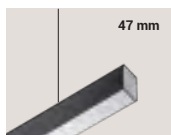

4051 Pg. 40



4052 Pg. 42



4053 Pg. 43

Perfis suspensos, projeção de luz descendente e ascendente



4566 Pg. 44



4060 Pg. 44

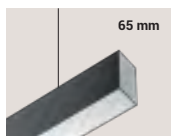

4560 Pg. 45



4061 Pg. 45

Perfis suspensos duplo, projeção de luz descendente

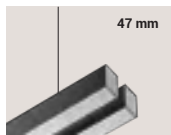

4056 Pg. 46

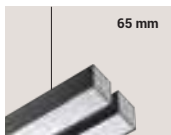

4057 Pg. 46

Perfis suspensos duplos, projeção de luz descendente e ascendente

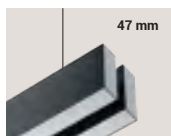

4062 Pg. 47

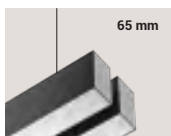

4562 Pg. 47

▶ **Perfis suspensos, projeção de luz descendente**

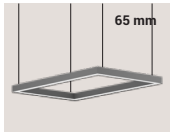

5050 Pg. 48

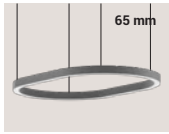

5051 Pg. 48

▶ **Perfis de parede, projeção de luz descendente ou ascendente**

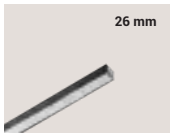

4520 | 4521 Pg. 50

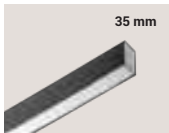

4536 Pg. 52



4021 Pg. 52

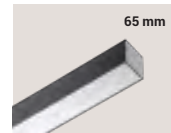

4022 Pg. 53



4023 Pg. 53

▶ **Perfis de parede, projeção de luz descendente e ascendente**



4546 Pg. 54

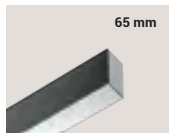

4024 Pg. 54



4020 Pg. 55

▶ **Perfis de encastrar com aba, projeção de luz descendente**

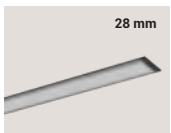

4501 Pg. 56

▶ **Perfis salientes, projeção de luz descendente**

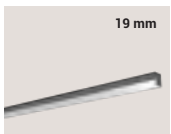

4512 Pg. 58

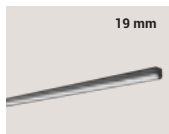

4517 Pg. 59

▶ **Perfis suspensos, projeção de luz descendente**

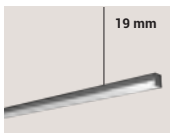

4522 Pg. 60

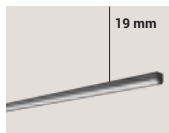

4527 Pg. 61

▶ **Sancas, projeção de luz ascendente**



4011 Pg. 62



4012 | 4013 Pg. 63



4515 Pg. 64

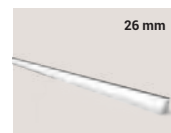

4516 Pg. 65



4530 | 4531

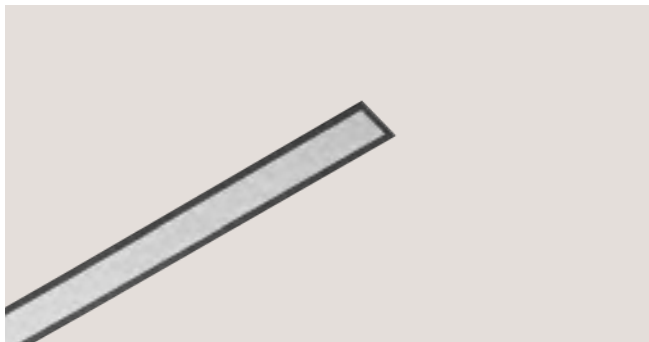

Informação Importante: Driver Remoto Incluído
(não integrado na luminária)

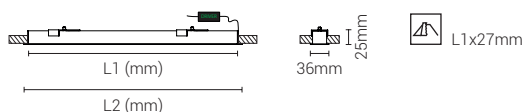

4530 IK04 IP40 Módulo LED						
Código	L1 (mm)	L2 (mm)	Fluxo/Pot. (aprox. 184lm/W)	HF (€)		DALI (€)
				4530	4630	
4530.015.xxL	150	158	490 lm	29,76	-	-
4530.029.xxL	290	298	980 lm	34,32	-	-
4530.043.xxL	430	438	1470 lm	41,01	-	-
4530.057.xxL	570	578	1960 lm	44,38	74,82	75,07
4530.071.xxL	710	718	2450 lm	59,85	81,51	81,76
4530.085.xxL	850	858	2940 lm	64,41	86,07	86,32
4530.099.xxL	990	998	3430 lm	71,10	92,76	93,01
4530.113.xxL	1130	1138	3920 lm	74,47	96,13	96,38
4530.127.xxL	1270	1278	4410 lm	81,16	102,83	103,07
4530.141.xxL	1410	1418	4900 lm	85,72	109,95	107,63
4530.155.xxL	1550	1558	5390 lm	92,53	116,77	114,45
4530.169.xxL	1690	1698	5880 lm	96,74	120,97	118,65
4530.183.xxL	1830	1838	6370 lm	103,43	127,66	125,34
4530.197.xxL	1970	1978	6860 lm	107,99	132,22	129,90
4530.211.xxL	2110	2118	7350 lm	114,68	138,91	136,59
4530.225.xxL	2250	2258	7840 lm	118,05	142,28	139,96
4530.239.xxL	2390	2398	8330 lm	124,74	148,97	146,65
4530.253.xxL	2530	2538	8820 lm	129,30	153,53	151,21
4530.267.xxL	2670	2678	9310 lm	135,99	159,29	157,91
4530.281.xxL	2810	2818	9800 lm	139,36	166,61	161,27
4530.295.xxL	2950	2958	10290 lm	146,05	173,62	167,97
4530.309.xxL	3090	3098	10780 lm	150,61	181,48	172,53
4530.323.xxL	3230	3238	11270 lm	157,43	190,30	179,34
4530.337.xxL	3370	3378	11760 lm	173,62	223,66	207,75
4530.351.xxL	3510	3518	12250 lm	180,31	230,36	214,44

2700K | 3000K | 4000K | 5000K | 6500K

4531 IK04 IP40 Fita LED					
Código	L1 (mm)	L2 (mm)	Fluxo/Pot. (aprox. 138lm/W)	HF (€)	
				4531	4731
4531.051.xxL	510	518	750 lm	43,29	94,08
4531.061.xxL	610	618	900 lm	47,76	98,54
4531.071.xxL	710	718	1050 lm	52,23	103,01
4531.081.xxL	810	818	1200 lm	56,69	107,48
4531.091.xxL	910	918	1350 lm	61,16	111,94
4531.101.xxL	1010	1018	1500 lm	65,63	116,41
4531.111.xxL	1110	1118	1650 lm	70,09	120,88
4531.121.xxL	1210	1218	1800 lm	74,56	125,34
4531.131.xxL	1310	1318	1950 lm	79,03	129,81
4531.141.xxL	1410	1418	2100 lm	83,49	134,28
4531.151.xxL	1510	1518	2250 lm	87,96	138,74
4531.161.xxL	1610	1618	2400 lm	93,26	144,04
4531.171.xxL	1710	1718	2550 lm	97,73	148,51
4531.181.xxL	1810	1818	2700 lm	102,19	152,98
4531.191.xxL	1910	1918	2850 lm	106,66	157,44
4531.201.xxL	2010	2018	3000 lm	111,12	161,91
4531.211.xxL	2110	2118	3150 lm	115,59	166,37
4531.221.xxL	2210	2218	3300 lm	120,06	170,84
4531.231.xxL	2310	2318	3450 lm	124,52	175,31
4531.241.xxL	2410	2418	3600 lm	128,99	179,77
4531.251.xxL	2510	2518	3750 lm	133,46	184,24
4531.261.xxL	2610	2618	3900 lm	137,92	188,71
4531.271.xxL	2710	2718	4050 lm	142,39	193,17
4531.281.xxL	2810	2818	4200 lm	167,72	213,28
4531.291.xxL	2910	2918	4350 lm	172,19	217,75
4531.301.xxL	3010	3018	4500 lm	176,65	222,21

2700K | 3000K | 4000K | 6500K | RGB sob consulta
1-10V sob consulta.

4531 IK04 IP65 Driver IP20 Fita LED					
Código	L1 (mm)	L2 (mm)	Fluxo/Pot. (aprox. 83,2lm/W)	HF (€)	
				4531	4731
4531.052.xxL	520	528	610 lm	44,84	95,62
4531.062.xxL	620	628	732 lm	49,62	100,40
4531.072.xxL	720	728	854 lm	54,39	105,17
4531.082.xxL	820	828	976 lm	59,17	109,95
4531.092.xxL	920	928	1098 lm	63,94	114,73
4531.102.xxL	1020	1028	1220 lm	68,72	119,50
4531.112.xxL	1120	1128	1342 lm	73,49	124,28
4531.122.xxL	1220	1228	1464 lm	78,27	129,05
4531.132.xxL	1320	1328	1586 lm	83,04	133,83
4531.142.xxL	1420	1428	1708 lm	87,82	138,60
4531.152.xxL	1520	1528	1830 lm	92,59	143,38
4531.162.xxL	1620	1628	1952 lm	98,20	148,99
4531.172.xxL	1720	1728	2074 lm	102,98	153,76
4531.182.xxL	1820	1828	2196 lm	107,76	158,54
4531.192.xxL	1920	1928	2318 lm	112,53	163,31
4531.202.xxL	2020	2028	2440 lm	117,31	168,09
4531.212.xxL	2120	2128	2562 lm	122,08	172,87
4531.222.xxL	2220	2228	2684 lm	126,86	177,64
4531.232.xxL	2320	2328	2806 lm	131,63	182,42
4531.242.xxL	2420	2428	2928 lm	136,41	187,19
4531.252.xxL	2520	2528	3050 lm	141,18	191,97
4531.262.xxL	2620	2628	3172 lm	145,96	196,74
4531.272.xxL	2720	2728	3294 lm	150,73	201,52
4531.282.xxL	2820	2828	3416 lm	176,37	221,93
4531.292.xxL	2920	2928	3538 lm	181,15	226,71
4531.302.xxL	3020	3028	3660 lm	185,92	231,48

2700K | 3000K | 4000K | 6000K | RGB sob consulta
1-10V sob consulta.



- 1

Branco

código: 4x3x.xxx.10L
- 2

Cinza

código: 4x3x.xxx.20L
- 3

Cinza Satinado

código: 4x3x.xxx.30L
- 4

Escovado

código: 4x3x.xxx.40L
- 7

Grafite

código: 4x3x.xxx.70L
- 9

Preto

código: 4x3x.xxx.90L
- 0

RAL sob Consulta

Podem ser instalados em linhas contínuas, com a forma e comprimento solicitados.
Driver com IP65 sob consulta.
No perfil 4530 Módulo LED IP40, é possível conjugar diferentes acessórios. Veja como, na página seguinte.



4530 Acessórios				
Código	L (mm)	Cor Acabamento	Fluxo/Pot. (aprox.)	HF (€)
4530.D14.xNX	140	Branco Preto	-	3,72
4530.D28.xNX	280	Branco Preto	-	6,07
4530.D56.xNX	560	Branco Preto	-	10,88
4530.D12.xNX	1120	Branco Preto	-	18,44
4530.L14.xTL	140	Branco Preto	5W - 700 lm	69,70
4530.L28.xTL	280	Branco Preto	6.5W - 1000 lm	104,65
4530.N07.xTL	70	Cor	1W - 140 lm	59,75
4530.N14.xTL	140	Cor	(2x) 1W - 140 lm	99,35
4530.N28.xTL	280	Cor	(3x) 1W - 140 lm	147,85
4530.P11.xTL	140	Cor	1W - 140 lm	59,75
4530.P13.xTL	140	Cor	1W - 140 lm	66,75
4530.P14.xTL	140	Cor	1W - 140 lm	73,75
4530.P21.xTL	280	Cor	(2x) 1W - 140 lm	114,50
4530.P23.xTL	280	Cor	(2x) 1W - 140 lm	123,50
4530.P24.xTL	280	Cor	(2x) 1W - 140 lm	137,50

As conjugações e a quantidade de módulos são definidas pelo cliente quando encomendadas, acrescentando, ao código do perfil, os códigos dos acessórios pretendidos e a sua distribuição. Estas combinações estão sujeitas a indicações e possíveis alterações. Várias conjugações significam mais de um **Driver Remoto Incluído**. A medida mínima para conjugações é de 560mm.

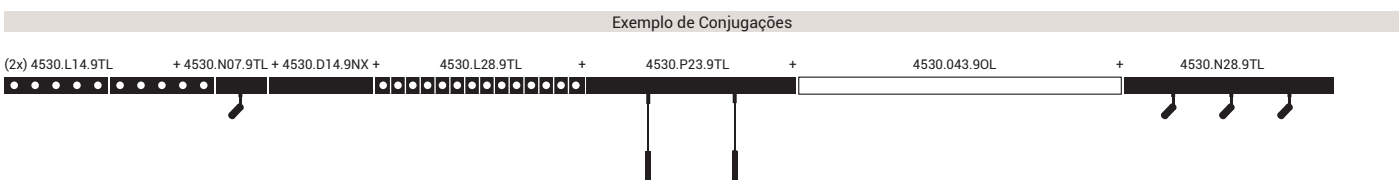
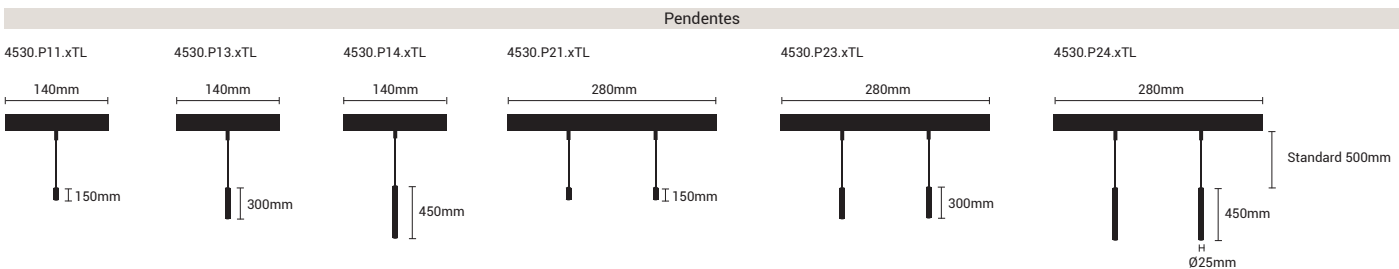
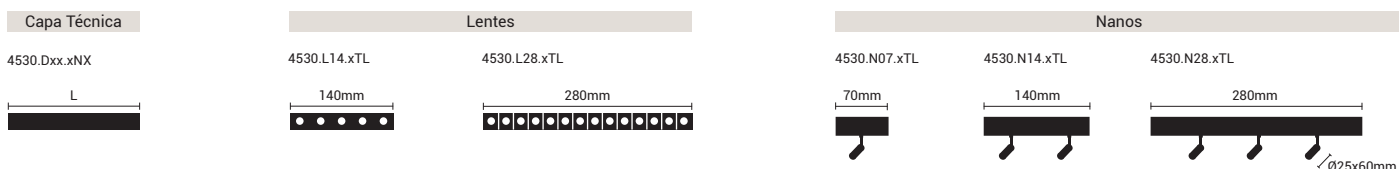

Opalino código: 4x3x.xxx.xOL
 Black código: 4x3x.xxx.xBL





4036

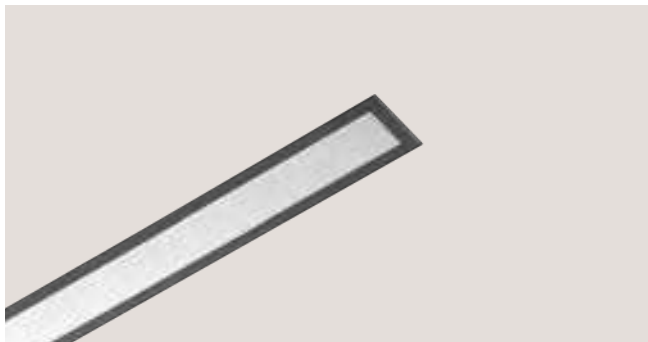

Informação Importante: Driver Remoto Incluído
(não integrado na luminária)

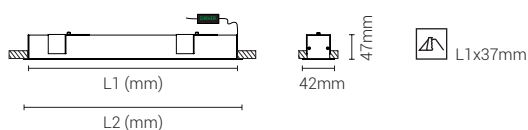

4036 IK04 IP40 Módulo LED						
Código	L1 (mm)	L2 (mm)	Fluxo/Pot. (aprox. 183lm/W)	HF (€) 4036	1-10V (€) 4136	DALI (€) 4236
4036.029.xxL	290	297	1100 lm	42,44	-	-
4036.043.xxL	430	437	1650 lm	50,76	-	-
4036.057.xxL	570	577	2200 lm	54,49	87,03	85,18
4036.071.xxL	710	717	2750 lm	71,43	95,35	93,50
4036.085.xxL	850	857	3300 lm	77,30	101,23	99,37
4036.099.xxL	990	997	3850 lm	85,62	109,54	107,69
4036.113.xxL	1130	1137	4400 lm	89,35	113,27	111,42
4036.127.xxL	1270	1277	4950 lm	97,82	122,05	119,73
4036.141.xxL	1410	1417	5500 lm	103,69	127,93	125,61
4036.155.xxL	1550	1557	6050 lm	112,01	136,24	133,92
4036.169.xxL	1690	1697	6600 lm	117,68	141,92	139,60
4036.183.xxL	1830	1837	7150 lm	126,00	150,23	147,92
4036.197.xxL	1970	1977	7700 lm	131,88	156,11	153,79
4036.211.xxL	2110	2117	8250 lm	140,44	164,67	162,36
4036.225.xxL	2250	2257	8800 lm	144,17	168,40	166,08
4036.239.xxL	2390	2397	9350 lm	165,31	214,43	199,44
4036.253.xxL	2530	2537	9900 lm	173,13	222,25	207,26
4036.267.xxL	2670	2677	10450 lm	181,45	230,57	215,58
4036.281.xxL	2810	2817	11000 lm	185,18	234,76	219,30
4036.295.xxL	2950	2957	11550 lm	193,50	243,54	227,62
4036.309.xxL	3090	3097	12100 lm	199,37	249,41	233,49
4036.323.xxL	3230	3237	12650 lm	207,69	257,73	241,81
4036.337.xxL	3370	3377	13200 lm	211,41	261,46	245,54
4036.351.xxL	3510	3517	13750 lm	231,42	271,41	273,64
4036.365.xxL	3650	3657	14300 lm	237,29	277,29	279,51
4036.379.xxL	3790	3797	14850 lm	245,61	285,60	287,83
4036.393.xxL	3930	3937	15400 lm	251,28	291,28	293,50
4036.407.xxL	4070	4077	15950 lm	259,60	299,60	301,82
4036.421.xxL	4210	4217	16500 lm	265,47	305,47	307,70
4036.435.xxL	4350	4357	17050 lm	273,79	313,79	316,01
4036.449.xxL	4490	4497	17600 lm	277,52	317,51	319,74
4036.463.xxL	4630	4637	18150 lm	298,66	363,54	353,09
4036.477.xxL	4770	4777	18700 lm	304,54	369,88	358,97
4036.491.xxL	4910	4917	19250 lm	312,85	378,20	367,29
4036.505.xxL	5050	5057	19800 lm	316,58	381,92	371,01

2700K | 3000K | 4000K | 5000K | 6500K



1

Branco

código:
4x36.xxx.1xL

2

Cinza

código:
4x36.xxx.2xL

3

Cinza Satinado

código:
4x36.xxx.3xL

4

Escovado

código:
4x36.xxx.4xL

7

Grafite

código:
4x36.xxx.7xL

9

Preto

código:
4x36.xxx.9xL

0

RAL sob Consulta

Podem ser instalados em linhas contínuas, com a forma e comprimento solicitados. Possibilidade de conjugar diferentes acessórios. Veja como, na página seguinte.



4036 Acessórios				
Código	L (mm)	Cor Acabamento	Fluxo/Pot. (aprox.)	HF (€)
4036.D14.xNX	140	Branco Preto	-	3,94
4036.D28.xNX	280	Branco Preto	-	6,42
4036.D56.xNX	560	Branco Preto	-	12,83
4036.D12.xNX	1120	Branco Preto	-	23,15
4036.L14.xTL	140	Branco Preto	5W - 700 lm	71,99
4036.L28.xTL	285	Branco Preto	12W - 1700 lm	125,30
4036.N14.xTL	140	Cor	3.5W - 500 lm	69,75
4036.N28.xTL	280	Cor	(2x) 3.5W - 500 lm	110,42
4036.P11.xTL	140	Cor	3.5W - 500 lm	69,75
4036.P13.xTL	140	Cor	3.5W - 500 lm	77,75
4036.P14.xTL	140	Cor	3.5W - 500 lm	85,75
4036.P21.xTL	280	Cor	(2x) 3.5W - 500 lm	129,50
4036.P23.xTL	280	Cor	(2x) 3.5W - 500 lm	145,50
4036.P24.xTL	280	Cor	(2x) 3.5W - 500 lm	161,50

As conjugações e a quantidade de módulos são definidas pelo cliente quando encomendadas, acrescentando, ao código do perfil, os códigos dos acessórios pretendidos e a sua distribuição. Estas combinações estão sujeitas a indicações e possíveis alterações. Várias conjugações significam mais de um **Driver Remoto Incluído**. A medida mínima para conjugações é de 560mm.

Capa Técnica

4036.Dxx.xNX



Lentes

4036.L14.xTL

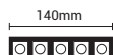

4036.L28.xTL



Nanos

4036.N14.xTL

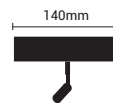

4036.N28.xTL

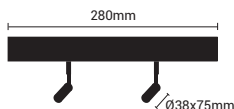

Pendentes

4036.P11.xTL

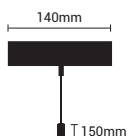

4036.P13.xTL

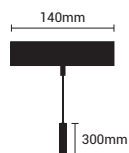

4036.P14.xTL

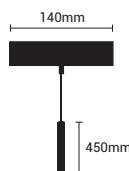

4036.P21.xTL

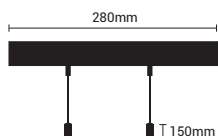

4036.P23.xTL

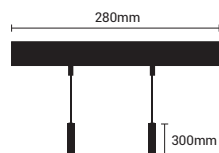

4036.P24.xTL

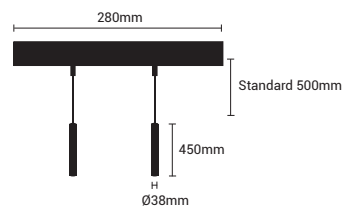

Exemplo de Conjugações

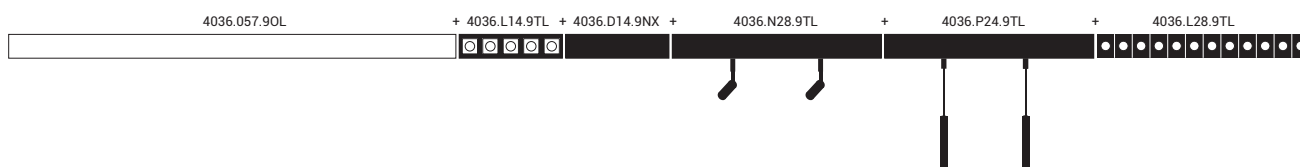

Opalino

código:
4x36.xxx.xOL



Prismático

código:
4x36.xxx.xPL



Black

código:
4x36.xxx.xBL



81,29€

104,78€

Estas luminárias podem incluir estes componentes eléctricos a partir de 1130mm.





4031

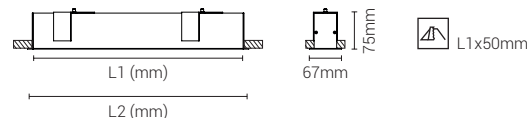

4031 IK05 IP40 Módulo LED						
Código	L1 (mm)	L2 (mm)	Fluxo/Pot. (aprox. 183lm/W)	HF (€)	1-10V (€)	DALI (€)
				4031	4131	4231
4031.029.xxL	290	310	1100 lm	47,54	-	-
4031.043.xxL	430	450	1650 lm	57,89	-	-
4031.057.xxL	570	590	2200 lm	63,65	96,19	94,34
4031.071.xxL	710	730	2750 lm	82,62	106,55	104,69
4031.085.xxL	850	870	3300 lm	90,53	114,45	112,60
4031.099.xxL	990	1010	3850 lm	100,88	124,81	122,95
4031.113.xxL	1130	1150	4400 lm	106,64	130,57	128,71
4031.127.xxL	1270	1290	4950 lm	117,15	141,38	139,06
4031.141.xxL	1410	1430	5500 lm	125,06	149,29	146,97
4031.155.xxL	1550	1570	6050 lm	135,41	159,64	157,32
4031.169.xxL	1690	1710	6600 lm	143,12	167,35	165,03
4031.183.xxL	1830	1850	7150 lm	153,47	177,70	175,38
4031.197.xxL	1970	1990	7700 lm	161,38	185,61	183,29
4031.211.xxL	2110	2130	8250 lm	171,97	196,21	193,89
4031.225.xxL	2250	2270	8800 lm	177,74	201,97	199,65
4031.239.xxL	2390	2410	9350 lm	200,91	250,03	235,04
4031.253.xxL	2530	2550	9900 lm	210,77	259,88	244,89
4031.267.xxL	2670	2690	10450 lm	221,12	270,23	255,24
4031.281.xxL	2810	2830	11000 lm	226,88	276,46	261,00
4031.295.xxL	2950	2970	11550 lm	237,23	287,27	271,36
4031.309.xxL	3090	3110	12100 lm	245,14	295,18	279,26
4031.323.xxL	3230	3250	12650 lm	255,49	305,53	289,62
4031.337.xxL	3370	3390	13200 lm	261,25	311,29	295,38
4031.351.xxL	3510	3530	13750 lm	283,29	323,28	325,51
4031.365.xxL	3650	3670	14300 lm	291,20	331,19	333,42
4031.379.xxL	3790	3810	14850 lm	301,55	341,54	343,77
4031.393.xxL	3930	3950	15400 lm	309,26	349,25	351,48
4031.407.xxL	4070	4090	15950 lm	319,61	359,60	361,83
4031.421.xxL	4210	4230	16500 lm	327,51	367,51	369,74
4031.435.xxL	4350	4370	17050 lm	337,87	377,86	380,09
4031.449.xxL	4490	4510	17600 lm	343,63	383,62	385,85
4031.463.xxL	4630	4650	18150 lm	366,80	431,68	421,24
4031.477.xxL	4770	4790	18700 lm	374,71	440,06	429,14
4031.491.xxL	4910	4930	19250 lm	385,06	450,41	439,50
4031.505.xxL	5050	5070	19800 lm	390,83	456,17	445,26

2700K | 3000K | 4000K | 5000K | 6500K

4031 - Difusor de Alumínio IK05 IP20 Módulo LED						
Código	L1 (mm)	L2 (mm)	Fluxo/Pot. (aprox. 183lm/W)	HF (€)	1-10V (€)	DALI (€)
				4031	4131	4231
4031.057.xAL	565	585	2200 lm	85,76	118,31	118,31
4031.085.xAL	845	865	3300 lm	113,27	137,66	137,66
4031.113.xAL	1125	1145	4400 lm	134,40	158,79	158,79
4031.141.xAL	1405	1425	5500 lm	158,04	183,51	183,51

2700K | 3000K | 4000K | 5000K | 6500K

4031 T - Calha Trifásica IK05 IP20				
Código	Sistema	L1 (mm)	L2 (mm)	€
4031.T10.xCX	Calha Trifásica 1000 mm	1085	1110	66,76
4031.T20.xCX	Calha Trifásica 2000 mm	2085	2110	121,91
4031.T30.xCX	Calha Trifásica 3000 mm	3085	3110	177,85

4031 Curvas IK05 IP40 Módulo LED							
Código	Raio Int. (mm)	Raio Ext. (mm)	Ângulo (°)	Fluxo/Pot. (aprox. 183lm/W)	HF (€)	1-10V (€)	DALI (€)
					4031	4131	4231
4031.C59.xOL	510,5	577,5	90	3300 lm	178,71	202,63	200,78
4031.C54.xOL	510,5	577,5	45	1650 lm	101,98	-	-
4031.C69.xOL	610,5	677,5	90	3850 lm	189,06	212,99	211,13
4031.C79.xOL	710,5	777,5	90	4400 lm	194,82	218,75	216,89
4031.C74.xOL	710,5	777,5	45	2200 lm	107,74	140,28	138,43
4031.C89.xOL	810,5	877,5	90	4950 lm	205,33	229,56	227,24
4031.C99.xOL	910,5	977,5	90	5500 lm	213,24	237,47	235,15
4031.C94.xOL	910,5	977,5	45	2750 lm	126,71	150,64	148,78
4031.C19.xOL	1035,5	1102,5	90	6600 lm	231,30	255,53	253,21
4031.C14.xOL	1035,5	1102,5	45	3300 lm	134,62	158,54	156,69
4031.C29.xOL	1235,5	1302,5	90	7700 lm	249,56	273,79	271,47
4031.C24.xOL	1235,5	1302,5	45	3850 lm	144,97	168,90	167,04

2700K | 3000K | 4000K | 5000K | 6500K

Curvas



Exemplo de Conjugações

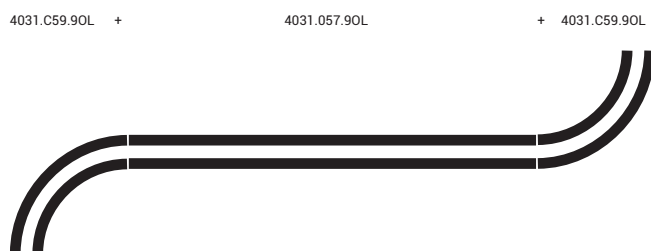

As conjugações e a quantidade de curvas são definidas pelo cliente quando encomendadas, acrescentando, ao código do perfil, os códigos dos perfis curvos pretendidos e a sua distribuição. Estas combinações estão sujeitas a indicações e possíveis alterações. As furações para aplicação só poderão ser feitas através do próprio produto. O difusor das curvas é sempre opalino.

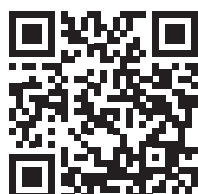

- | | | | | | | |
|----------------------|----------------------|----------------------|----------------------|----------------------|----------------------|------------------|
| 1 | 2 | 3 | 4 | 7 | 9 | 0 |
| Branco | Cinza | Cinza Satinado | Escovado | Grafite | Preto | RAL sob Consulta |
| código: 4x31.xxx.1xL | código: 4x31.xxx.2xL | código: 4x31.xxx.3xL | código: 4x31.xxx.4xL | código: 4x31.xxx.7xL | código: 4x31.xxx.9xL | |

Podem ser instalados em linhas contínuas, com a forma e comprimento solicitados. Possibilidade de conjugar diferentes acessórios. Veja como, na página seguinte.



4031 Acessórios				
Código	L (mm)	Cor Acabamento	Fluxo/Pot. (aprox.)	HF (€)
4031.D14.xNX	140	Branco Preto	-	4,69
4031.D28.xNX	280	Branco Preto	-	7,32
4031.D56.xNX	560	Branco Preto	-	14,69
4031.D12.xNX	1120	Branco Preto	-	23,88
4031.L28.xTL	280	Branco Preto	7,7W - 1300 lm	88,35
4031.L18.xTL	180	Metalizado	5W - 700 lm	72,45
4031.N14.xTL	140mm	Cor	8,6W - 1350 lm	79,53
4031.N28.xTL	280	Cor	(2x) 8,6W - 1350 lm	110,25
4031.P11.xTL	140	Cor	8,6W - 1350 lm	79,53
4031.P13.xTL	140	Cor	8,6W - 1350 lm	88,53
4031.P14.xTL	140	Cor	8,6W - 1350 lm	96,53
4031.P21.xTL	280	Cor	(2x) 8,6W - 1350 lm	149,06
4031.P23.xTL	280	Cor	(2x) 8,6W - 1350 lm	167,06
4031.P24.xTL	280	Cor	(2x) 8,6W - 1350 lm	183,06

As conjugações e a quantidade de módulos são definidas pelo cliente quando encomendadas, acrescentando, ao código do perfil, os códigos dos acessórios pretendidos e a sua distribuição. Estas combinações estão sujeitas a indicações e possíveis alterações. A medida mínima para conjugações é de 560mm.

Capa Técnica

4031.Dxx.xNX



Lentes

4031.L28.xTL

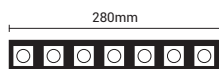

4031.L18.xTL

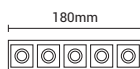

Nanos

4031.N14.xTL

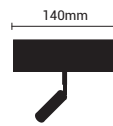

4031.N28.xTL

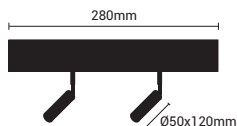

Pendentes

4031.P11.xTL

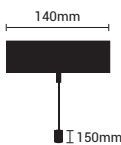

4031.P13.xTL

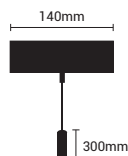

4031.P14.xTL

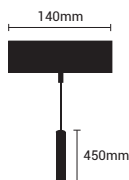

4031.P21.xTL

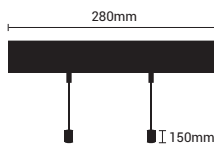

4031.P23.xTL

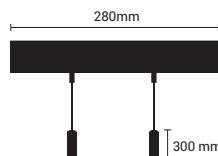

4031.P24.xTL

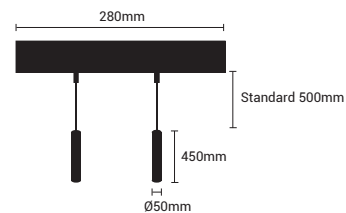

Exemplo de Conjugações

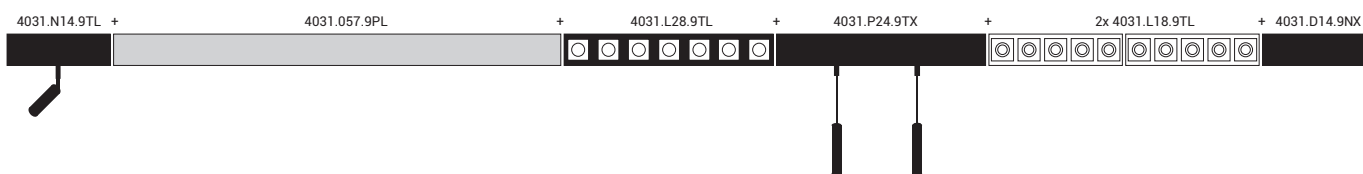

Opalino

código:
4x31.xxx.xOL



Prismático

código:
4x31.xxx.xPL



Alumínio

código:
4x31.xxx.xAL



Calha Trifásica

código:
4031.Txx.xCX



Black

código:
4x31.xxx.xBL



KIT EMG
1H

81,29€



KIT EMG
3H

104,78€

Estas luminárias podem incluir estes componentes eléctricos a partir de 1130mm.





4032

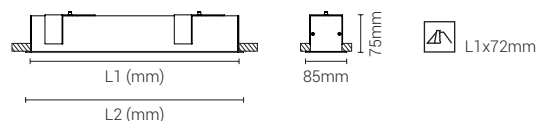
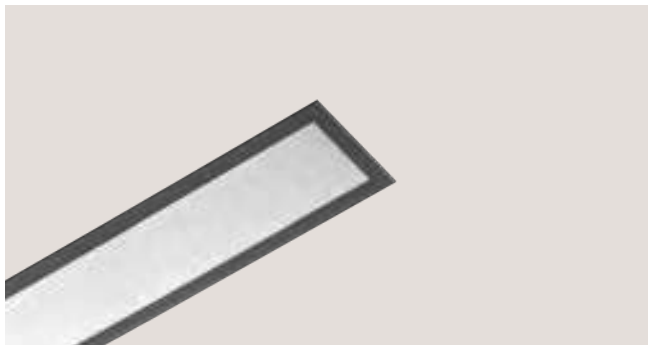

4032 | IK05 | IP40 | Módulo LED

Código	L1 (mm)	L2 (mm)	Fluxo/Pot. (aprox. 183lm/W)	HF (€)		
				4032	1-10V (€)	DALI (€)
4032.029.xxL	290	310	1100 lm	48,45	-	-
4032.043.xxL	430	450	1650 lm	59,09	-	-
4032.057.xxL	570	590	2200 lm	65,14	97,69	95,83
4032.071.xxL	710	730	2750 lm	84,40	108,33	106,47
4032.085.xxL	850	870	3300 lm	92,60	116,52	114,67
4032.099.xxL	990	1010	3850 lm	103,24	127,17	125,31
4032.113.xxL	1130	1150	4400 lm	109,29	133,22	131,36
4032.127.xxL	1270	1290	4950 lm	120,09	144,32	142,00
4032.141.xxL	1410	1430	5500 lm	128,29	152,52	150,20
4032.155.xxL	1550	1570	6050 lm	138,93	163,16	160,84
4032.169.xxL	1690	1710	6600 lm	147,02	171,25	168,93
4032.183.xxL	1830	1850	7150 lm	157,66	181,89	179,57
4032.197.xxL	1970	1990	7700 lm	165,86	190,09	187,77
4032.211.xxL	2110	2130	8250 lm	176,75	200,98	198,66
4032.225.xxL	2250	2270	8800 lm	182,80	207,03	204,71
4032.239.xxL	2390	2410	9350 lm	206,27	255,38	240,39
4032.253.xxL	2530	2550	9900 lm	216,50	265,62	250,63
4032.267.xxL	2670	2690	10450 lm	227,14	276,26	261,27
4032.281.xxL	2810	2830	11000 lm	233,20	282,77	267,32
4032.295.xxL	2950	2970	11550 lm	243,84	293,88	277,96
4032.309.xxL	3090	3110	12100 lm	252,04	302,08	286,16
4032.323.xxL	3230	3250	12650 lm	262,68	312,72	296,80
4032.337.xxL	3370	3390	13200 lm	268,73	318,77	302,85
4032.351.xxL	3510	3530	13750 lm	291,05	331,05	333,27
4032.365.xxL	3650	3670	14300 lm	299,25	339,25	341,47
4032.379.xxL	3790	3810	14850 lm	309,89	349,89	352,11
4032.393.xxL	3930	3950	15400 lm	317,98	357,98	360,20
4032.407.xxL	4070	4090	15950 lm	328,62	368,62	370,84
4032.421.xxL	4210	4230	16500 lm	336,82	376,82	379,04
4032.435.xxL	4350	4370	17050 lm	347,46	387,46	389,68
4032.449.xxL	4490	4510	17600 lm	353,51	393,51	395,73
4032.463.xxL	4630	4650	18150 lm	376,98	441,86	431,41
4032.477.xxL	4770	4790	18700 lm	385,18	450,52	439,61
4032.491.xxL	4910	4930	19250 lm	395,82	461,16	450,25
4032.505.xxL	5050	5070	19800 lm	401,87	467,21	456,30

2700K | 3000K | 4000K | 5000K | 6500K

4032 - Difusor de Alumínio | IK05 | IP20 | Módulo LED

Código	L1 (mm)	L2 (mm)	Fluxo/Pot. (aprox. 183lm/W)	HF (€)		
				4032	1-10V (€)	DALI (€)
4032.057.xAL	565	585	2200 lm	77,08	109,62	107,77
4032.085.xAL	845	865	3300 lm	108,14	132,07	130,21
4032.113.xAL	1125	1145	4400 lm	132,30	156,22	154,37
4032.141.xAL	1405	1425	5500 lm	168,34	192,58	190,26

2700K | 3000K | 4000K | 5000K | 6500K

4032 | Curvas | IK05 | IP40 | Módulo LED

Código	Raio Int. (mm)	Raio Ext. (mm)	Ângulo (°)	Fluxo/Pot. (aprox. 183lm/W)	HF (€)		
					4032	1-10V (€)	DALI (€)
4032.C59.xOL	510	595	90	3300 lm	180,78	204,70	202,85
4032.C54.xOL	510	595	45	1650 lm	103,18	-	-
4032.C69.xOL	610	695	90	3850 lm	191,42	215,35	213,49
4032.C79.xOL	710	795	90	4400 lm	197,47	221,40	219,54
4032.C74.xOL	710	795	45	2200 lm	109,23	141,78	139,92
4032.C89.xOL	810	895	90	4950 lm	208,27	232,50	230,18
4032.C99.xOL	910	995	90	5500 lm	216,47	240,70	238,38
4032.C94.xOL	910	995	45	2750 lm	128,49	152,42	150,09
4032.C19.xOL	1035	1120	90	6600 lm	235,20	259,43	257,11
4032.C14.xOL	1035	1120	45	3300 lm	136,69	160,61	158,76
4032.C29.xOL	1235	1320	90	7700 lm	254,04	278,18	275,95
4032.C24.xOL	1235	1320	45	3850 lm	147,33	171,26	169,40

2700K | 3000K | 4000K | 5000K | 6500K

Curvas

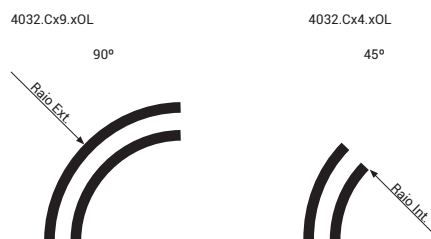

Exemplo de Conjugações

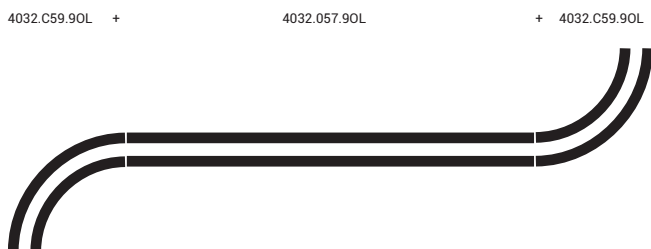

As conjugações e a quantidade de curvas são definidas pelo cliente quando encomendadas, acrescentando, ao código do perfil, os códigos dos perfis curvos pretendidos e a sua distribuição. Estas combinações estão sujeitas a indicações e possíveis alterações.

As furações para aplicação só poderão ser feitas através do próprio produto.

O difusor das curvas é sempre opalino.

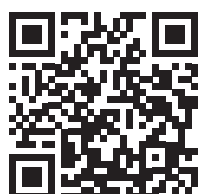

1

Branco
código:
4x3x.xxx.1xL

2

Cinza
código:
4x3x.xxx.2xL

3

Cinza Satinado
código:
4x3x.xxx.3xL

4

Escovado
código:
4x3x.xxx.4xL

7

Grafite
código:
4x3x.xxx.7xL

9

Preto
código:
4x3x.xxx.9xL

0

RAL sob Consulta

Pode ser instalado em linhas contínuas, com a forma e comprimento solicitados.



4033

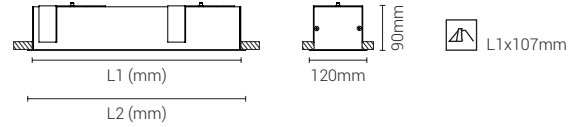
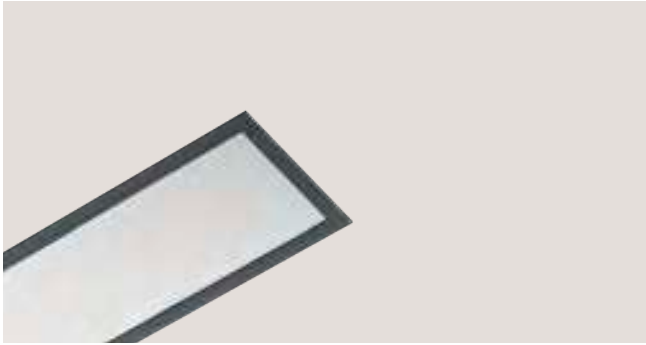

4033 IK05 IP40 Módulo LED						
Código	L1 (mm)	L2 (mm)	Fluxo/Pot. (aprox. 183lm/W)	HF (€)		
				4033	1-10V (€)	DALI (€)
4033.029.xxL	290	310	1100 lm	59,04	-	-
4033.043.xxL	430	450	1650 lm	71,41	-	-
4033.057.xxL	570	590	2200 lm	79,20	111,75	109,89
4033.071.xxL	710	730	2750 lm	100,20	124,12	122,27
4033.085.xxL	850	870	3300 lm	110,13	134,06	132,20
4033.099.xxL	990	1010	3850 lm	122,51	146,43	144,58
4033.113.xxL	1130	1150	4400 lm	130,29	154,22	152,36
4033.127.xxL	1270	1290	4950 lm	142,82	167,06	164,74
4033.141.xxL	1410	1430	5500 lm	152,76	176,99	174,67
4033.155.xxL	1550	1570	6050 lm	165,13	189,37	187,05
4033.169.xxL	1690	1710	6600 lm	176,38	200,61	198,30
4033.183.xxL	1830	1850	7150 lm	188,76	212,99	210,67
4033.197.xxL	1970	1990	7700 lm	198,69	222,93	220,61
4033.211.xxL	2110	2130	8250 lm	212,37	236,60	234,28
4033.225.xxL	2250	2270	8800 lm	220,15	244,39	242,07
4033.239.xxL	2390	2410	9350 lm	245,36	294,47	279,48
4033.253.xxL	2530	2550	9900 lm	258,75	307,87	292,88
4033.267.xxL	2670	2690	10450 lm	271,13	320,24	305,25
4033.281.xxL	2810	2830	11000 lm	278,91	328,49	313,04
4033.295.xxL	2950	2970	11550 lm	291,29	341,33	325,41
4033.309.xxL	3090	3110	12100 lm	301,22	351,27	335,35
4033.323.xxL	3230	3250	12650 lm	313,60	363,64	347,72
4033.337.xxL	3370	3390	13200 lm	321,39	371,43	355,51
4033.351.xxL	3510	3530	13750 lm	346,50	386,49	388,72
4033.365.xxL	3650	3670	14300 lm	356,43	396,43	398,65
4033.379.xxL	3790	3810	14850 lm	368,81	408,80	411,03
4033.393.xxL	3930	3950	15400 lm	380,05	420,05	422,28
4033.407.xxL	4070	4090	15950 lm	392,43	432,43	434,65
4033.421.xxL	4210	4230	16500 lm	402,36	442,36	444,59
4033.435.xxL	4350	4370	17050 lm	414,74	454,74	456,96
4033.449.xxL	4490	4510	17600 lm	422,53	462,52	464,75
4033.463.xxL	4630	4650	18150 lm	447,73	512,61	502,16
4033.477.xxL	4770	4790	18700 lm	457,66	523,01	512,10
4033.491.xxL	4910	4930	19250 lm	470,04	535,38	524,47
4033.505.xxL	5050	5070	19800 lm	477,83	543,17	532,26

2700K | 3000K | 4000K | 5000K | 6500K

4033 - Difusor de Alumínio IK05 IP20 Módulo LED						
Código	L1 (mm)	L2 (mm)	Fluxo/Pot. (aprox. 183lm/W)	HF (€)		
				4033	1-10V (€)	DALI (€)
4033.057.xAL	565	585	2200 lm	94,61	127,15	125,30
4033.085.xAL	845	865	3300 lm	125,68	149,60	147,75
4033.113.xAL	1125	1145	4400 lm	146,24	170,16	168,31
4033.141.xAL	1405	1425	5500 lm	177,11	201,34	199,02
4033.257.xAL	565	585	4400 lm	114,39	138,16	136,30
4033.285.xAL	845	865	6600 lm	155,91	166,85	164,99
4033.211.xAL	1125	1145	8800 lm	181,23	192,17	190,32
4033.215.xAL	1405	1425	11000 lm	218,19	229,59	227,27

2700K | 3000K | 4000K | 5000K | 6500K



Opalino

código:
4x3x.xxx.xOL



Prismático

código:
4x3x.xxx.xPL



Alumínio

código:
4x3x.xxx.xAL



Black

código:
4x32.xxx.xBL



81,29€



104,78€

Estas luminárias podem incluir estes componentes elétricos a partir de 1130mm.





4524 | 4525

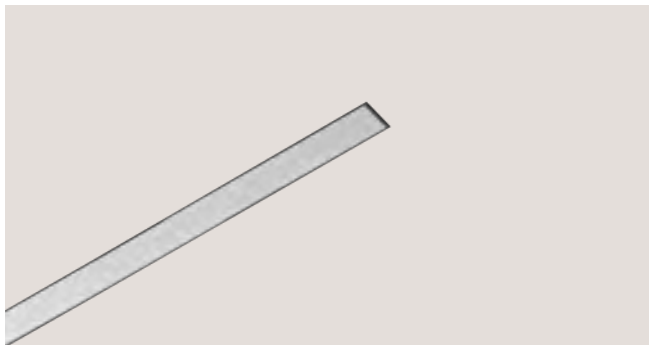

Informação Importante: Driver Remoto Incluído
(não integrado na luminária)

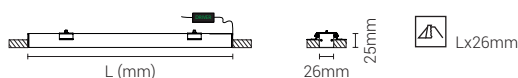

4524 IK04 IP40 Módulo LED					
Código	L (mm)	Fluxo/Pot. (aprox. 184lm/W)	HF (€) 4524	1-10V (€) 4624	DALI (€) 4724
4524.015.xxL	150	490 lm	30,07	-	-
4524.029.xxL	290	980 lm	34,62	-	-
4524.043.xxL	430	1470 lm	41,32	-	-
4524.057.xxL	570	1960 lm	44,69	75,13	75,38
4524.071.xxL	710	2450 lm	60,16	81,82	82,07
4524.085.xxL	850	2940 lm	64,71	86,38	86,63
4524.099.xxL	990	3430 lm	71,41	93,07	93,32
4524.113.xxL	1130	3920 lm	74,78	96,44	96,69
4524.127.xxL	1270	4410 lm	81,47	103,13	103,38
4524.141.xxL	1410	4900 lm	86,03	110,26	107,94
4524.155.xxL	1550	5390 lm	92,84	117,07	114,76
4524.169.xxL	1690	5880 lm	97,20	121,43	119,11
4524.183.xxL	1830	6370 lm	103,89	128,12	125,81
4524.197.xxL	1970	6860 lm	108,45	132,68	130,37
4524.211.xxL	2110	7350 lm	115,14	139,38	137,06
4524.225.xxL	2250	7840 lm	118,51	142,74	140,43
4524.239.xxL	2390	8330 lm	125,20	149,44	147,12
4524.253.xxL	2530	8820 lm	129,76	154,00	151,68
4524.267.xxL	2670	9310 lm	136,45	196,76	158,37
4524.281.xxL	2810	9800 lm	139,82	200,13	161,74
4524.295.xxL	2950	10290 lm	146,52	206,82	168,43
4524.309.xxL	3090	10780 lm	151,07	213,94	172,99
4524.323.xxL	3230	11270 lm	157,89	220,76	179,80
4524.337.xxL	3370	11760 lm	174,09	224,13	208,21
4524.351.xxL	3510	12250 lm	180,78	230,82	214,90

2700K | 3000K | 4000K | 5000K | 6500K

4525 IK04 IP40 Fita LED				
Código	L (mm)	Fluxo/Pot. (aprox. 138lm/W)	HF (€) 4525	DALI (€) 4725
4525.051.xxL	510	750 lm	43,60	94,39
4525.061.xxL	610	900 lm	48,07	98,85
4525.071.xxL	710	1050 lm	52,54	103,32
4525.081.xxL	810	1200 lm	57,00	107,79
4525.091.xxL	910	1350 lm	61,47	112,25
4525.101.xxL	1010	1500 lm	65,94	116,72
4525.111.xxL	1110	1650 lm	70,40	121,19
4525.121.xxL	1210	1800 lm	74,87	125,65
4525.131.xxL	1310	1950 lm	79,33	130,12
4525.141.xxL	1410	2100 lm	83,80	134,58
4525.151.xxL	1510	2250 lm	88,27	139,05
4525.161.xxL	1610	2400 lm	93,72	144,51
4525.171.xxL	1710	2550 lm	98,19	148,97
4525.181.xxL	1810	2700 lm	102,66	153,44
4525.191.xxL	1910	2850 lm	107,12	157,91
4525.201.xxL	2010	3000 lm	111,59	162,37
4525.211.xxL	2110	3150 lm	116,05	166,84
4525.221.xxL	2210	3300 lm	120,52	171,30
4525.231.xxL	2310	3450 lm	124,99	175,77
4525.241.xxL	2410	3600 lm	129,45	180,24
4525.251.xxL	2510	3750 lm	133,92	184,70
4525.261.xxL	2610	3900 lm	138,39	189,17
4525.271.xxL	2710	4050 lm	142,85	193,64
4525.281.xxL	2810	4200 lm	168,18	213,74
4525.291.xxL	2910	4350 lm	172,65	218,21
4525.301.xxL	3010	4500 lm	177,12	222,68

2700K | 3000K | 4000K | 6500K | RGB sob consulta

1-10V sob consulta

4525 IK04 IP65 Driver IP20 Fita LED				
Código	L (mm)	Fluxo/Pot. (aprox. 83,2lm/W)	HF (€) 4525	DALI (€) 4725
4525.052.xxL	520	610 lm	45,15	95,93
4525.062.xxL	620	732 lm	49,92	100,71
4525.072.xxL	720	854 lm	54,70	105,48
4525.082.xxL	820	976 lm	59,48	110,26
4525.092.xxL	920	1098 lm	64,25	115,03
4525.102.xxL	1020	1220 lm	69,03	119,81
4525.112.xxL	1120	1342 lm	73,80	124,59
4525.122.xxL	1220	1464 lm	78,58	129,36
4525.132.xxL	1320	1586 lm	83,35	134,14
4525.142.xxL	1420	1708 lm	88,13	138,91
4525.152.xxL	1520	1830 lm	92,90	143,69
4525.162.xxL	1620	1952 lm	98,67	149,45
4525.172.xxL	1720	2074 lm	103,44	154,23
4525.182.xxL	1820	2196 lm	108,22	159,00
4525.192.xxL	1920	2318 lm	112,99	163,78
4525.202.xxL	2020	2440 lm	117,77	168,55
4525.212.xxL	2120	2562 lm	122,55	173,33
4525.222.xxL	2220	2684 lm	127,32	178,10
4525.232.xxL	2320	2806 lm	132,10	182,88
4525.242.xxL	2420	2928 lm	136,87	187,66
4525.252.xxL	2520	3050 lm	141,65	192,43
4525.262.xxL	2620	3172 lm	146,42	197,21
4525.272.xxL	2720	3294 lm	151,20	201,98
4525.282.xxL	2820	3416 lm	176,84	222,40
4525.292.xxL	2920	3538 lm	181,61	227,17
4525.302.xxL	3020	3660 lm	186,39	231,95

2700K | 3000K | 4000K | 6000K | RGB sob consulta

1-10V sob consulta



- | | | | | | | |
|----------------------|----------------------|----------------------|----------------------|----------------------|----------------------|------------------|
| 1 | 2 | 3 | 4 | 7 | 9 | 0 |
| Branco | Cinza | Cinza Satinado | Escovado | Grafite | Preto | RAL sob Consulta |
| código: 4x2x.xxx.10L | código: 4x2x.xxx.20L | código: 4x2x.xxx.30L | código: 4x2x.xxx.40L | código: 4x2x.xxx.70L | código: 4x2x.xxx.90L | |

Podem ser instalados em linhas contínuas, com a forma e comprimento solicitados.
No perfil 4524 Módulo LED IP40, é possível conjugar diferentes acessórios. Veja como, na página seguinte.



4524 Acessórios				
Código	L (mm)	Cor Acabamento	Fluxo/Pot. (aprox.)	HF (€)
4524.D14.xNX	140	Branco Preto	-	3,72
4524.D28.xNX	280	Branco Preto	-	6,07
4524.D56.xNX	560	Branco Preto	-	10,88
4524.D12.xNX	1120	Branco Preto	-	18,44
4524.L14.xTL	140	Branco Preto	5W - 700 lm	69,70
4524.L28.xTL	280	Branco Preto	6.5W - 1000 lm	104,65
4524.N07.xTL	70	Cor	1W - 140 lm	59,75
4524.N14.xTL	140	Cor	(2x) 1W - 140 lm	99,35
4524.N28.xTL	280	Cor	(3x) 1W - 140 lm	147,85
4524.P11.xTL	140	Cor	1W - 140 lm	59,75
4524.P13.xTL	140	Cor	1W - 140 lm	66,75
4524.P14.xTL	140	Cor	1W - 140 lm	73,75
4524.P21.xTL	280	Cor	(2x) 1W - 140 lm	114,50
4524.P23.xTL	280	Cor	(2x) 1W - 140 lm	123,50
4524.P24.xTL	280	Cor	(2x) 1W - 140 lm	137,50

As conjugações e a quantidade de módulos são definidas pelo cliente quando encomendadas, acrescentando, ao código do perfil, os códigos dos acessórios pretendidos e a sua distribuição. Estas combinações estão sujeitas a indicações e possíveis alterações. Várias conjugações significam mais de um **Driver Remoto Incluído**. A medida mínima para conjugações é de 560mm.

Capa Técnica

4524.Dxx.xNX



Lentes

4524.L14.xTL



4524.L28.xTL



Nanos

4524.N07.xTL



4524.N14.xTL

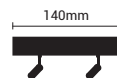

4524.N28.xTL

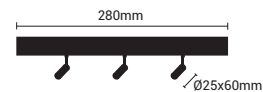

Pendentes

4524.P11.xTL

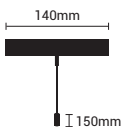

4524.P13.xTL

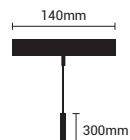

4524.P14.xTL

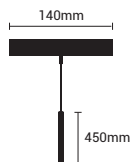

4524.P21.xTL

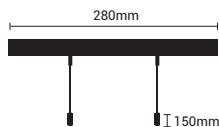

4524.P23.xTL

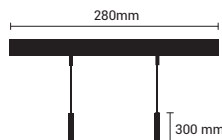

4524.P24.xTL

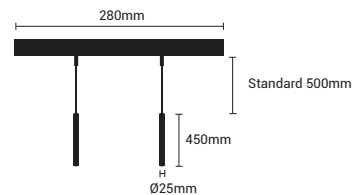

Exemplo de Conjugações

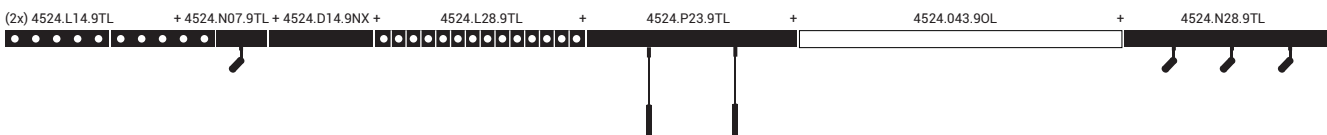

Opalino

código:
4x2x.xxx.xOL



Black

código:
4x2x.xxx.xBL





4526

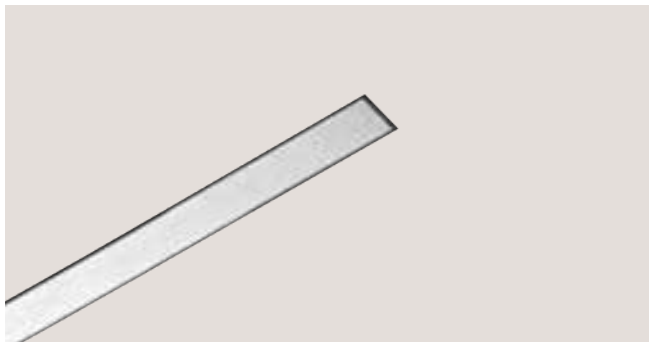

Informação Importante: Driver Remoto Incluído
(não integrado na luminária)

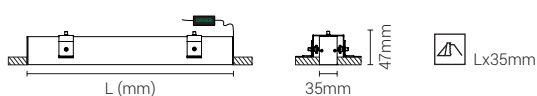

4526 IK04 IP40 Módulo LED					
Código	L (mm)	Fluxo/Pot. (aprox. 183lm/W)	HF (€)	1-10V (€)	DALI (€)
			4526	4626	4726
4526.029.xxL	290	1100 lm	49,18	-	-
4526.043.xxL	430	1650 lm	57,67	-	-
4526.057.xxL	570	2200 lm	61,57	94,12	92,26
4526.071.xxL	710	2750 lm	78,68	102,61	100,75
4526.085.xxL	850	3300 lm	84,73	108,66	106,80
4526.099.xxL	990	3850 lm	93,22	117,15	115,29
4526.113.xxL	1130	4400 lm	97,12	121,05	119,19
4526.127.xxL	1270	4950 lm	105,77	130,00	127,68
4526.141.xxL	1410	5500 lm	111,82	136,05	133,73
4526.155.xxL	1550	6050 lm	120,31	144,54	142,22
4526.169.xxL	1690	6600 lm	129,31	153,54	151,22
4526.183.xxL	1830	7150 lm	137,80	162,03	159,71
4526.197.xxL	1970	7700 lm	143,84	168,08	165,76
4526.211.xxL	2110	8250 lm	152,58	176,81	174,50
4526.225.xxL	2250	8800 lm	156,48	180,71	178,40
4526.239.xxL	2390	9350 lm	177,80	226,91	211,92
4526.253.xxL	2530	9900 lm	188,95	238,06	223,07
4526.267.xxL	2670	10450 lm	197,44	246,55	231,56
4526.281.xxL	2810	11000 lm	201,34	250,92	235,46
4526.295.xxL	2950	11550 lm	209,83	259,87	243,95
4526.309.xxL	3090	12100 lm	215,88	265,92	250,00
4526.323.xxL	3230	12650 lm	224,37	274,41	258,49
4526.337.xxL	3370	13200 lm	228,27	278,31	262,39
4526.351.xxL	3510	13750 lm	248,44	288,44	290,66
4526.365.xxL	3650	14300 lm	254,49	294,48	296,71
4526.379.xxL	3790	14850 lm	262,98	302,97	305,20
4526.393.xxL	3930	15400 lm	271,98	311,98	314,20
4526.407.xxL	4070	15950 lm	280,47	320,47	322,69
4526.421.xxL	4210	16500 lm	286,52	326,51	328,74
4526.435.xxL	4350	17050 lm	295,01	335,00	337,23
4526.449.xxL	4490	17600 lm	298,91	338,90	341,13
4526.463.xxL	4630	18150 lm	320,22	385,10	374,66
4526.477.xxL	4770	18700 lm	326,27	391,61	380,70
4526.491.xxL	4910	19250 lm	334,76	400,10	389,19
4526.505.xxL	5050	19800 lm	338,66	404,01	393,09

2700K | 3000K | 4000K | 5000K | 6500K



1

Branco

código:
4x26.xxx.1xL

2

Cinza

código:
4x26.xxx.2xL

3

Cinza Satinado

código:
4x26.xxx.3xL

4

Escovado

código:
4x26.xxx.4xL

7

Grafite

código:
4x26.xxx.7xL

9

Preto

código:
4x26.xxx.9xL

0

RAL sob Consulta

Podem ser instalados em linhas contínuas, com a forma e comprimento solicitados. Possibilidade de conjugar diferentes acessórios. Veja como, na página seguinte.

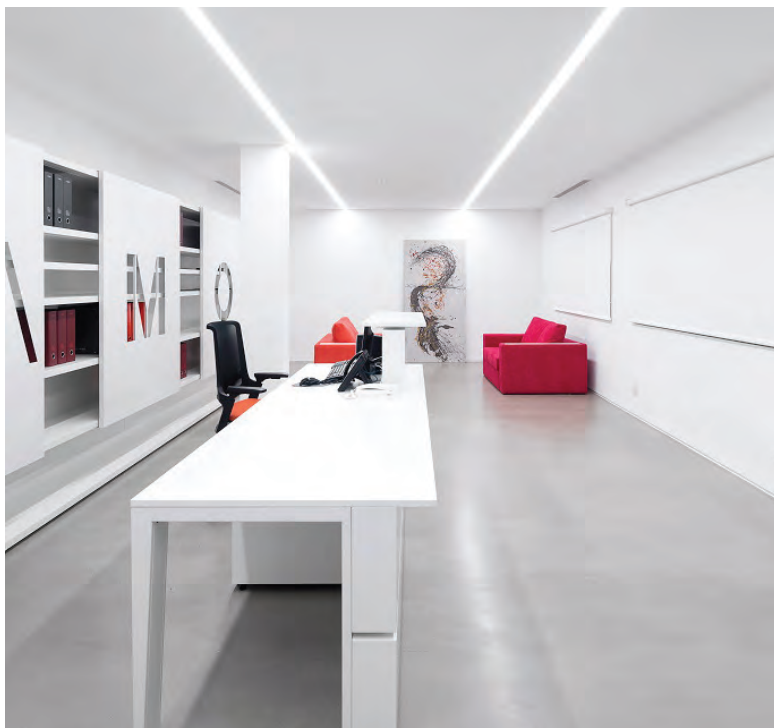

4526 Acessórios				
Código	L (mm)	Cor Acabamento	Fluxo/Pot. (aprox.)	HF (€)
4526.D14.xNX	140	Branco Preto	-	3,94
4526.D28.xNX	280	Branco Preto	-	6,42
4526.D56.xNX	560	Branco Preto	-	12,83
4526.D12.xNX	1120	Branco Preto	-	23,15
4526.L14.xTL	140	Branco Preto	5W - 700 lm	71,99
4526.L28.xTL	285	Branco Preto	12W - 1700 lm	125,30
4526.N14.xTL	140	Cor	3.5W - 500 lm	69,75
4526.N28.xTL	280	Cor	(2x) 3.5W - 500 lm	110,42
4526.P11.xTL	140	Cor	3.5W - 500 lm	69,75
4526.P13.xTL	140	Cor	3.5W - 500 lm	77,75
4526.P14.xTL	140	Cor	3.5W - 500 lm	85,75
4526.P21.xTL	280	Cor	(2x) 3.5W - 500 lm	129,50
4526.P23.xTL	280	Cor	(2x) 3.5W - 500 lm	145,50
4526.P24.xTL	280	Cor	(2x) 3.5W - 500 lm	161,50

As conjugações e a quantidade de módulos são definidas pelo cliente quando encomendadas, acrescentando, ao código do perfil, os códigos dos acessórios pretendidos e a sua distribuição. Estas combinações estão sujeitas a indicações e possíveis alterações. Várias conjugações significam mais de um **Driver Remoto Incluído**. A medida mínima para conjugações é de 560mm.

Capa Técnica

4526.Dxx.xNX



Lentes

4526.L14.xTL

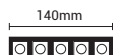

4526.L28.xTL



Nanos

4526.N14.xTL

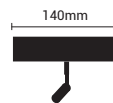

4526.N28.xTL

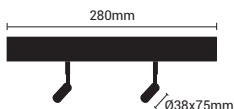

Pendentes

4526.P11.xTL

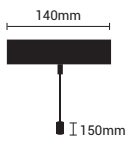

4526.P13.xTL

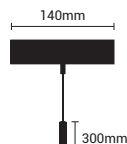

4526.P14.xTL

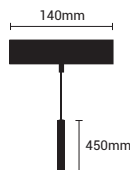

4526.P21.xTL

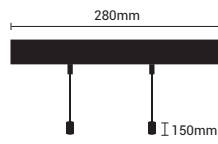

4526.P23.xTL

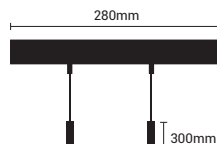

4526.P24.xTL

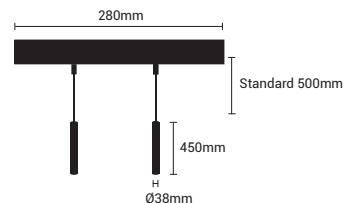

Exemplo de Conjugações

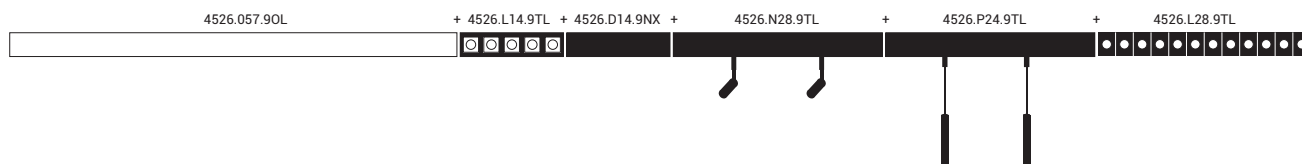

Opalino

código:
4x26.xxx.xOL



Prismático

código:
4x26.xxx.xPL



Black

código:
4x26.xxx.xBL



81,29€

104,78€

Estas luminárias podem incluir estes componentes elétricos a partir de 1130mm.





4026

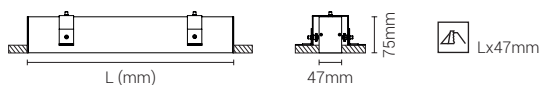
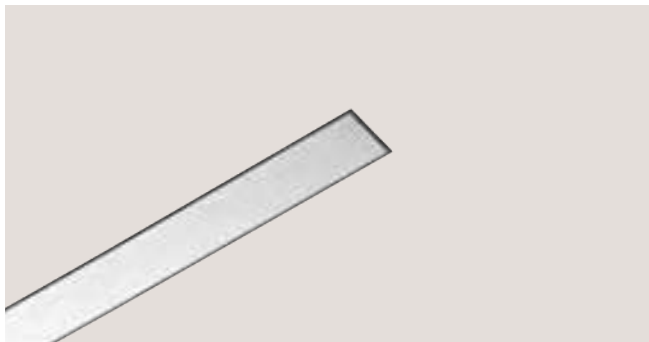

4026 | IK05 | IP40 | Módulo LED

Código	L (mm)	Fluxo/Pot. (aprox. 183lm/W)	Preço		
			HF (€) 4026	1-10V (€) 4126	DALI (€) 4226
4026.029.xxL	290	1100 lm	53,77	-	-
4026.043.xxL	430	1650 lm	64,09	-	-
4026.057.xxL	570	2200 lm	69,83	102,37	100,52
4026.071.xxL	710	2750 lm	88,78	112,70	110,84
4026.085.xxL	850	3300 lm	96,66	120,58	118,73
4026.099.xxL	990	3850 lm	106,98	130,91	129,05
4026.113.xxL	1130	4400 lm	112,72	136,64	134,79
4026.127.xxL	1270	4950 lm	123,20	147,43	145,11
4026.141.xxL	1410	5500 lm	131,08	155,31	153,00
4026.155.xxL	1550	6050 lm	141,41	165,64	163,32
4026.169.xxL	1690	6600 lm	152,24	176,47	174,16
4026.183.xxL	1830	7150 lm	162,57	186,80	184,48
4026.197.xxL	1970	7700 lm	170,45	194,68	192,36
4026.211.xxL	2110	8250 lm	181,02	205,25	202,94
4026.225.xxL	2250	8800 lm	186,76	210,99	208,67
4026.239.xxL	2390	9350 lm	209,91	259,02	244,03
4026.253.xxL	2530	9900 lm	222,89	272,01	257,01
4026.267.xxL	2670	10450 lm	233,22	282,33	267,34
4026.281.xxL	2810	11000 lm	238,95	288,53	273,07
4026.295.xxL	2950	11550 lm	249,28	299,32	283,40
4026.309.xxL	3090	12100 lm	257,16	307,20	291,28
4026.323.xxL	3230	12650 lm	267,48	317,53	301,61
4026.337.xxL	3370	13200 lm	273,22	323,26	307,34
4026.351.xxL	3510	13750 lm	295,23	335,22	337,45
4026.365.xxL	3650	14300 lm	303,11	343,11	345,33
4026.379.xxL	3790	14850 lm	313,43	353,43	355,66
4026.393.xxL	3930	15400 lm	324,27	364,27	366,49
4026.407.xxL	4070	15950 lm	334,59	374,59	376,82
4026.421.xxL	4210	16500 lm	342,48	382,47	384,70
4026.435.xxL	4350	17050 lm	352,80	392,80	395,02
4026.449.xxL	4490	17600 lm	358,54	398,53	400,76
4026.463.xxL	4630	18150 lm	381,69	446,57	436,12
4026.477.xxL	4770	18700 lm	389,57	454,91	444,00
4026.491.xxL	4910	19250 lm	399,90	465,24	454,33
4026.505.xxL	5050	19800 lm	405,63	470,97	460,06

2700K | 3000K | 4000K | 5000K | 6500K

4026 - Difusor de Alumínio | IK05 | IP20 | Módulo LED

Código	L (mm)	Fluxo/Pot. (aprox. 183lm/W)	Preço		
			HF (€) 4026	1-10V (€) 4126	DALI (€) 4226
4026.057.xAL	565	2200 lm	106,01	138,55	136,70
4026.085.xAL	845	3300 lm	119,21	143,13	141,28
4026.113.xAL	1125	4400 lm	139,25	163,17	161,32
4026.141.xAL	1405	5500 lm	163,79	188,03	185,71

2700K | 3000K | 4000K | 5000K | 6500K



1

Branco

código:
4x26.xxx.1xL

2

Cinza

código:
4x26.xxx.2xL

3

Cinza Satinado

código:
4x26.xxx.3xL

4

Escovado

código:
4x26.xxx.4xL

7

Grafite

código:
4x26.xxx.7xL

9

Preto

código:
4x26.xxx.9xL

0

RAL sob Consulta

Podem ser instalados em linhas contínuas, com a forma e comprimento solicitados. Possibilidade de conjugar diferentes acessórios. Veja como, na página seguinte.

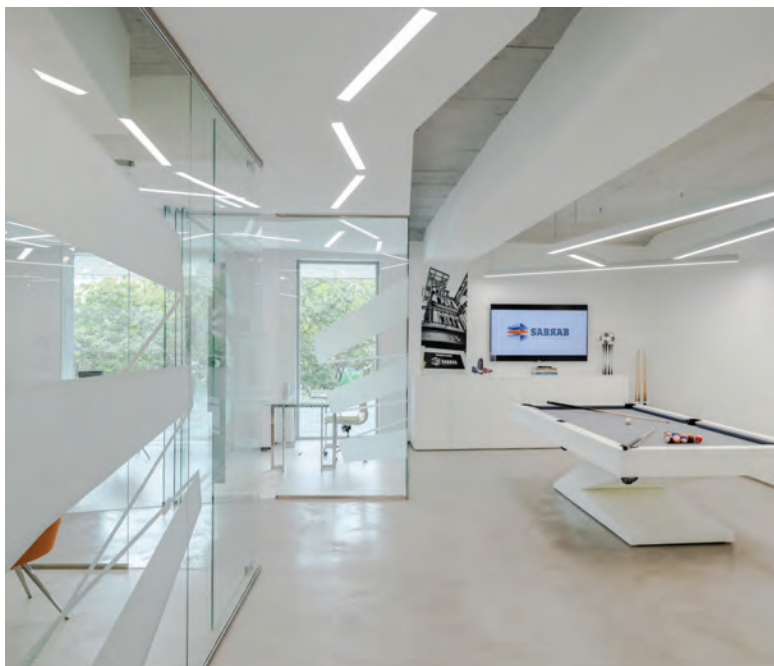

4026 Acessórios				
Código	L (mm)	Cor Acabamento	Fluxo/Pot. (aprox.)	HF (€)
4026.D14.xNX	140	Branco Preto	-	4,69
4026.D28.xNX	280	Branco Preto	-	7,32
4026.D56.xNX	560	Branco Preto	-	14,69
4026.D12.xNX	1120	Branco Preto	-	23,88
4026.L28.xTL	280	Branco Preto	7,7W - 1300 lm	88,35
4026.L18.xTL	180	Metalizado	5W - 700 lm	72,45
4026.N14.xTL	140	Cor	8,6W - 1350 lm	79,53
4026.N28.xTL	280	Cor	(2x) 8,6W - 1350 lm	110,25
4026.P11.xTL	140	Cor	8,6W - 1350 lm	79,53
4026.P13.xTL	140	Cor	8,6W - 1350 lm	88,53
4026.P14.xTL	140	Cor	8,6W - 1350 lm	96,53
4026.P21.xTL	280	Cor	(2x) 8,6W - 1350 lm	149,06
4026.P23.xTL	280	Cor	(2x) 8,6W - 1350 lm	167,06
4026.P24.xTL	280	Cor	(2x) 8,6W - 1350 lm	183,06

As conjugações e a quantidade de módulos são definidas pelo cliente quando encomendadas, acrescentando, ao código do perfil, os códigos dos acessórios pretendidos e a sua distribuição. Estas combinações estão sujeitas a indicações e possíveis alterações. A medida mínima para conjugações é de 560mm.

Capa Técnica

4026.Dxx.xNX



Lentes

4026.L28.xTL

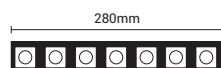

4026.L18.xTL

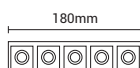

Nanos

4026.N14.xTL

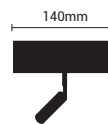

4026.N28.xTL

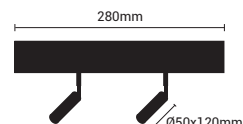

Pendentes

4026.P11.xTL

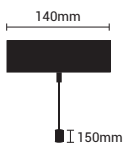

4026.P13.xTL

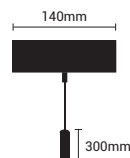

4026.P14.xTL

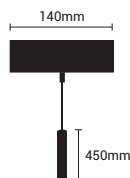

4026.P21.xTL

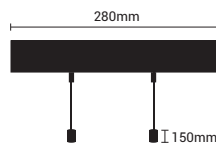

4026.P23.xTL

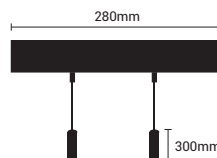

4026.P24.xTL

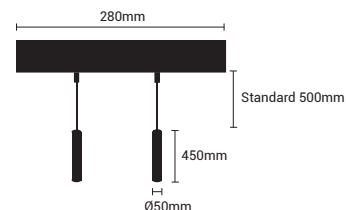

Exemplo de Conjugações

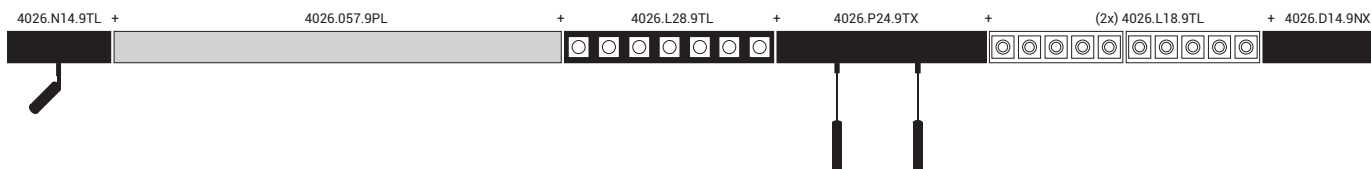

Opalino

código:
4x26.xxx.xOL



Prismático

código:
4x26.xxx.xPL



Alumínio

código:
4x26.xxx.xAL



Black

código:
4x26.xxx.xBL



KIT EMG
1H

81,29€



KIT EMG
3H

104,78€

Estas luminárias podem incluir estes componentes elétricos a partir de 1130mm.





4027

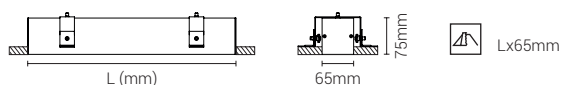
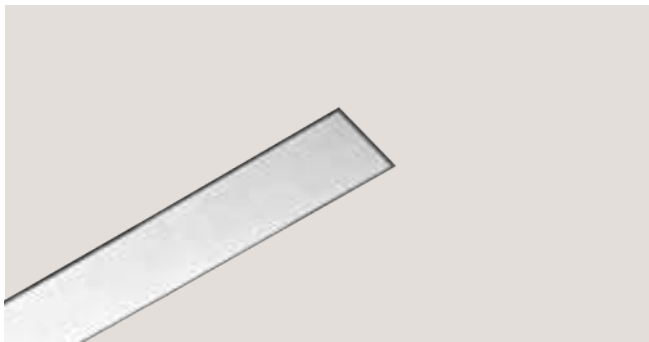

4027 IK05 IP40 Módulo LED					
Código	L (mm)	Fluxo/Pot. (aprox. 183lm/W)	HF (€) 4027	1-10V (€) 4127	DALI (€) 4227
4027.029.xxL	290	1100 lm	54,80	-	-
4027.043.xxL	430	1650 lm	65,42	-	-
4027.057.xxL	570	2200 lm	71,44	103,99	102,13
4027.071.xxL	710	2750 lm	90,68	114,60	112,75
4027.085.xxL	850	3300 lm	98,85	122,78	120,92
4027.099.xxL	990	3850 lm	109,47	133,39	131,54
4027.113.xxL	1130	4400 lm	115,49	139,42	137,56
4027.127.xxL	1270	4950 lm	126,26	150,49	148,18
4027.141.xxL	1410	5500 lm	134,43	158,67	156,35
4027.155.xxL	1550	6050 lm	145,05	169,28	166,96
4027.169.xxL	1690	6600 lm	156,33	180,56	178,24
4027.183.xxL	1830	7150 lm	166,94	191,18	188,86
4027.197.xxL	1970	7700 lm	175,12	199,35	197,03
4027.211.xxL	2110	8250 lm	185,98	210,21	207,89
4027.225.xxL	2250	8800 lm	192,00	216,24	213,92
4027.239.xxL	2390	9350 lm	215,45	264,56	249,57
4027.253.xxL	2530	9900 lm	228,87	277,99	263,00
4027.267.xxL	2670	10450 lm	239,49	288,60	273,61
4027.281.xxL	2810	11000 lm	245,51	295,09	279,64
4027.295.xxL	2950	11550 lm	256,13	306,17	290,25
4027.309.xxL	3090	12100 lm	264,30	314,34	298,42
4027.323.xxL	3230	12650 lm	274,91	324,96	309,04
4027.337.xxL	3370	13200 lm	280,94	330,98	315,06
4027.351.xxL	3510	13750 lm	303,24	343,23	345,46
4027.365.xxL	3650	14300 lm	311,41	351,41	353,63
4027.379.xxL	3790	14850 lm	322,03	362,02	364,25
4027.393.xxL	3930	15400 lm	333,31	373,30	375,53
4027.407.xxL	4070	15950 lm	343,92	383,92	386,14
4027.421.xxL	4210	16500 lm	352,09	392,09	394,31
4027.435.xxL	4350	17050 lm	362,71	402,70	404,93
4027.449.xxL	4490	17600 lm	368,73	408,73	410,95
4027.463.xxL	4630	18150 lm	392,17	457,07	446,61
4027.477.xxL	4770	18700 lm	400,35	465,69	454,78
4027.491.xxL	4910	19250 lm	410,96	476,30	465,39
4027.505.xxL	5050	19800 lm	416,99	482,33	471,42

2700K | 3000K | 4000K | 5000K | 6500K

4027 - Difusor de Alumínio IK05 IP20 Módulo LED					
Código	L (mm)	Fluxo/Pot. (aprox. 183lm/W)	HF (€) 4027	1-10V (€) 4127	DALI (€) 4227
4027.057.xAL	565	2200 lm	83,38	115,93	114,07
4027.085.xAL	845	3300 lm	114,39	138,32	136,46
4027.113.xAL	1125	4400 lm	138,50	162,42	160,57
4027.141.xAL	1405	5500 lm	174,49	198,72	196,41

2700K | 3000K | 4000K | 5000K | 6500K



1	2	3	4	7	9	0
Branco	Cinza	Cinza Satinado	Escovado	Grafite	Preto	RAL sob Consulta
código: 4x2x.xxx.1xL	código: 4x2x.xxx.2xL	código: 4x2x.xxx.3xL	código: 4x2x.xxx.4xL	code: 4x2x.xxx.7xL	código: 4x2x.xxx.9xL	

Podem ser instalados em linhas contínuas, com a forma e comprimento solicitados.



4025

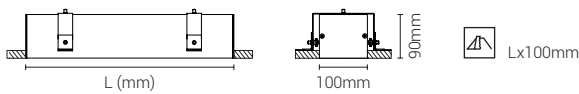
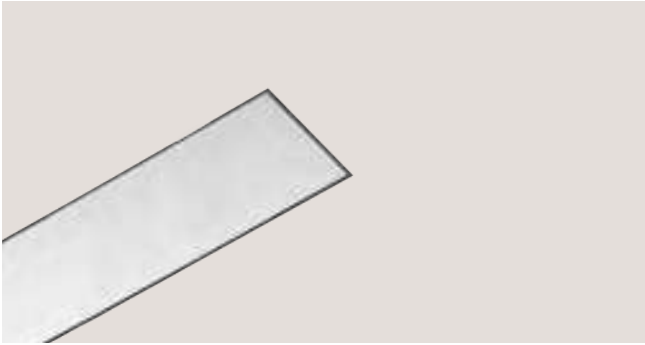

4025 | IK05 | IP40 | Módulo LED

Código	L (mm)	Fluxo/Pot. (aprox. 183lm/W)	HF (€)		
			4025	1-10V (€) 4125	DALI (€) 4225
4025.029.xxL	290	1100 lm	63,68	-	-
4025.043.xxL	430	1650 lm	76,00	-	-
4025.057.xxL	570	2200 lm	83,73	116,27	114,42
4025.071.xxL	710	2750 lm	104,66	128,59	126,73
4025.085.xxL	850	3300 lm	114,54	138,46	136,61
4025.099.xxL	990	3850 lm	126,85	150,78	148,92
4025.113.xxL	1130	4400 lm	134,58	158,50	156,65
4025.127.xxL	1270	4950 lm	147,05	171,28	168,96
4025.141.xxL	1410	5500 lm	156,92	181,16	178,84
4025.155.xxL	1550	6050 lm	169,24	193,47	191,15
4025.169.xxL	1690	6600 lm	182,84	207,07	204,75
4025.183.xxL	1830	7150 lm	195,15	219,38	217,07
4025.197.xxL	1970	7700 lm	205,02	229,26	226,94
4025.211.xxL	2110	8250 lm	218,64	242,87	240,55
4025.225.xxL	2250	8800 lm	226,36	250,60	248,28
4025.239.xxL	2390	9350 lm	251,51	300,62	285,63
4025.253.xxL	2530	9900 lm	267,25	316,37	301,38
4025.267.xxL	2670	10450 lm	279,57	328,68	313,69
4025.281.xxL	2810	11000 lm	287,29	336,87	321,42
4025.295.xxL	2950	11550 lm	299,61	349,65	333,73
4025.309.xxL	3090	12100 lm	309,48	359,52	343,61
4025.323.xxL	3230	12650 lm	321,80	371,84	355,92
4025.337.xxL	3370	13200 lm	329,52	379,57	363,65
4025.351.xxL	3510	13750 lm	354,57	394,57	396,80
4025.365.xxL	3650	14300 lm	364,45	404,44	406,67
4025.379.xxL	3790	14850 lm	376,76	416,76	418,98
4025.393.xxL	3930	15400 lm	390,36	430,36	432,58
4025.407.xxL	4070	15950 lm	402,68	442,67	444,90
4025.421.xxL	4210	16500 lm	412,55	452,55	454,77
4025.435.xxL	4350	17050 lm	424,87	464,86	467,09
4025.449.xxL	4490	17600 lm	432,59	472,59	474,81
4025.463.xxL	4630	18150 lm	457,73	522,61	512,16
4025.477.xxL	4770	18700 lm	467,61	532,95	522,04
4025.491.xxL	4910	19250 lm	479,92	545,26	534,35
4025.505.xxL	5050	19800 lm	487,65	552,99	542,08

2700K | 3000K | 4000K | 5000K | 6500K

4025 - Difusor de Alumínio | IK05 | IP20 | Módulo LED

Código	L (mm)	Fluxo/Pot. (aprox. 183lm/W)	HF (€)		
			4025	1-10V (€) 4125	DALI (€) 4225
4025.057.xAL	565	2200 lm	98,87	131,42	129,57
4025.085.xAL	845	3300 lm	130,08	154,01	152,15
4025.113.xAL	1125	4400 lm	150,53	174,45	172,59
4025.141.xAL	1405	5500 lm	181,27	205,51	203,19
4025.257.xAL	565	4400 lm	109,95	142,50	140,65
4025.285.xAL	845	6600 lm	147,78	171,70	169,85
4025.211.xAL	1125	8800 lm	185,67	196,61	194,76
4025.215.xAL	1405	11000 lm	229,28	234,28	231,96

2700K | 3000K | 4000K | 5000K | 6500K



Opalino

código:
4x2x.xxx.xOL

Prismático

código:
4x2x.xxx.xPL

Alumínio

código:
4x2x.xxx.xAL

Black

código:
4x27.xxx.xBL

81,29€



104,78€

Estas luminárias podem incluir estes componentes elétricos a partir de 1130mm.





4540 | 4541

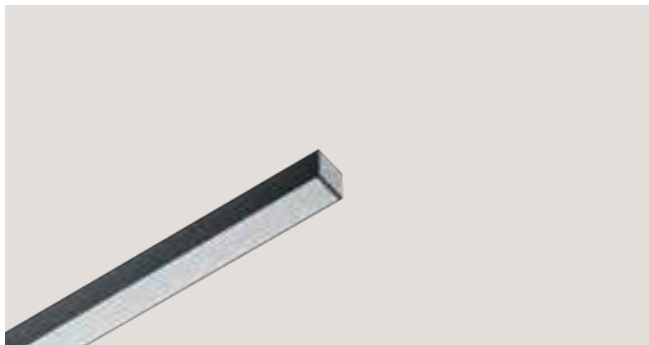

Informação Importante: Driver Remoto Incluído
(não integrado na luminária)

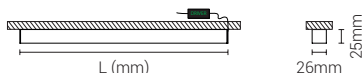

4540 IK04 IP40 Módulo LED					
Código	L (mm)	Fluxo/Pot. (aprox. 184lm/W)	HF (€)	1-10V (€)	DALI (€)
			4540	4640	4740
4540.015.xxL	150	490 lm	28,09	-	-
4540.029.xxL	290	980 lm	32,65	-	-
4540.043.xxL	430	1470 lm	39,34	-	-
4540.057.xxL	570	1960 lm	42,71	73,15	73,40
4540.071.xxL	710	2450 lm	58,02	79,84	80,09
4540.085.xxL	850	2940 lm	62,58	84,40	84,65
4540.099.xxL	990	3430 lm	69,27	91,10	91,34
4540.113.xxL	1130	3920 lm	72,64	94,46	94,71
4540.127.xxL	1270	4410 lm	79,33	101,16	101,40
4540.141.xxL	1410	4900 lm	83,89	108,28	105,96
4540.155.xxL	1550	5390 lm	90,71	115,10	112,78
4540.169.xxL	1690	5880 lm	94,08	118,47	116,15
4540.183.xxL	1830	6370 lm	100,92	125,16	122,84
4540.197.xxL	1970	6860 lm	105,48	129,72	127,40
4540.211.xxL	2110	7350 lm	112,18	136,41	134,09
4540.225.xxL	2250	7840 lm	115,54	139,78	137,46
4540.239.xxL	2390	8330 lm	122,24	146,47	144,15
4540.253.xxL	2530	8820 lm	126,80	151,03	148,71
4540.267.xxL	2670	9310 lm	133,49	157,72	155,40
4540.281.xxL	2810	9800 lm	136,86	159,16	158,77
4540.295.xxL	2950	10290 lm	143,55	203,85	165,45
4540.309.xxL	3090	10780 lm	148,11	210,98	170,02
4540.323.xxL	3230	11270 lm	154,92	217,92	176,84
4540.337.xxL	3370	11760 lm	171,12	221,16	205,24
4540.351.xxL	3510	12250 lm	177,81	227,85	211,93

2700K | 3000K | 4000K | 5000K | 6500K

4541 IK04 IP40 Fita LED				
Código	L (mm)	Fluxo/Pot. (aprox. 138lm/W)	HF (€)	DALI (€)
			4541	4741
4541.051.xxL	510	750 lm	41,63	92,41
4541.061.xxL	610	900 lm	46,09	96,88
4541.071.xxL	710	1050 lm	50,56	101,34
4541.081.xxL	810	1200 lm	55,02	105,81
4541.091.xxL	910	1350 lm	59,49	110,27
4541.101.xxL	1010	1500 lm	63,96	114,74
4541.111.xxL	1110	1650 lm	68,42	119,21
4541.121.xxL	1210	1800 lm	72,89	123,67
4541.131.xxL	1310	1950 lm	77,36	128,14
4541.141.xxL	1410	2100 lm	81,82	132,61
4541.151.xxL	1510	2250 lm	86,29	137,07
4541.161.xxL	1610	2400 lm	90,76	141,54
4541.171.xxL	1710	2550 lm	95,22	146,01
4541.181.xxL	1810	2700 lm	99,69	150,47
4541.191.xxL	1910	2850 lm	104,15	154,94
4541.201.xxL	2010	3000 lm	108,62	159,40
4541.211.xxL	2110	3150 lm	113,09	163,87
4541.221.xxL	2210	3300 lm	117,55	168,34
4541.231.xxL	2310	3450 lm	122,02	172,80
4541.241.xxL	2410	3600 lm	126,49	177,27
4541.251.xxL	2510	3750 lm	130,95	181,74
4541.261.xxL	2610	3900 lm	135,42	186,20
4541.271.xxL	2710	4050 lm	139,89	190,67
4541.281.xxL	2810	4200 lm	144,36	195,14
4541.291.xxL	2910	4350 lm	148,82	199,60
4541.301.xxL	3010	4500 lm	153,29	204,07

2700K | 3000K | 4000K | 6500K | RGB sob consulta

1-10V sob consulta

4541 IK04 IP65 Driver IP20 Fita LED				
Código	L (mm)	Fluxo/Pot. (aprox. 83,2lm/W)	HF (€)	DALI (€)
			4541	4741
4541.052.xxL	520	610 lm	43,17	93,95
4541.062.xxL	620	732 lm	47,95	98,73
4541.072.xxL	720	854 lm	52,72	103,51
4541.082.xxL	820	976 lm	57,50	108,28
4541.092.xxL	920	1098 lm	62,27	113,06
4541.102.xxL	1020	1220 lm	67,05	117,83
4541.112.xxL	1120	1342 lm	71,82	122,61
4541.122.xxL	1220	1464 lm	76,60	127,38
4541.132.xxL	1320	1586 lm	81,37	132,16
4541.142.xxL	1420	1708 lm	86,15	136,93
4541.152.xxL	1520	1830 lm	90,93	141,71
4541.162.xxL	1620	1952 lm	95,70	146,48
4541.172.xxL	1720	2074 lm	100,48	151,26
4541.182.xxL	1820	2196 lm	105,25	156,04
4541.192.xxL	1920	2318 lm	110,03	160,81
4541.202.xxL	2020	2440 lm	114,80	165,59
4541.212.xxL	2120	2562 lm	119,58	170,36
4541.222.xxL	2220	2684 lm	124,35	175,14
4541.232.xxL	2320	2806 lm	129,13	179,91
4541.242.xxL	2420	2928 lm	133,90	184,69
4541.252.xxL	2520	3050 lm	138,68	189,46
4541.262.xxL	2620	3172 lm	143,46	194,24
4541.272.xxL	2720	3294 lm	148,23	199,01
4541.282.xxL	2820	3416 lm	153,01	203,78
4541.292.xxL	2920	3538 lm	157,79	208,56
4541.302.xxL	3020	3660 lm	162,56	213,33

2700K | 3000K | 4000K | 6000K | RGB sob consulta

1-10V sob consulta



1

Branco

código:
4x4x.xxx.10L

2

Cinza

código:
4x4x.xxx.20L

3

Cinza Satinado

código:
4x4x.xxx.30L

4

Escovado

código:
4x4x.xxx.40L

7

Grafite

código:
4x4x.xxx.70L

9

Preto

código:
4x4x.xxx.90L

0

RAL sob Consulta

Podem ser instalados em linhas contínuas, com a forma e comprimento solicitados.
No perfil 4540 Módulo LED IP40, é possível conjugar diferentes acessórios. Veja como, na página seguinte.



4540 Acessórios				
Código	L (mm)	Cor Acabamento	Fluxo/Pot. (aprox.)	HF (€)
4540.D14.xNX	140	Branco Preto	-	3,72
4540.D28.xNX	280	Branco Preto	-	6,07
4540.D56.xNX	560	Branco Preto	-	10,88
4540.D12.xNX	1120	Branco Preto	-	18,44
4540.L14.xTL	140	Branco Preto	5W - 700 lm	69,70
4540.L28.xTL	280	Branco Preto	6.5W - 1000 lm	104,65
4540.N07.xTL	70	Cor	1W - 140 lm	59,75
4540.N14.xTL	140	Cor	(2x) 1W - 140 lm	99,35
4540.N28.xTL	280	Cor	(3x) 1W - 140 lm	147,85
4540.P11.xTL	140	Cor	1W - 140 lm	59,75
4540.P13.xTL	140	Cor	1W - 140 lm	66,75
4540.P14.xTL	140	Cor	1W - 140 lm	73,75
4540.P21.xTL	280	Cor	(2x) 1W - 140 lm	114,50
4540.P23.xTL	280	Cor	(2x) 1W - 140 lm	123,50
4540.P24.xTL	280	Cor	(2x) 1W - 140 lm	137,50

As conjugações e a quantidade de módulos são definidas pelo cliente quando encomendadas, acrescentando, ao código do perfil, os códigos dos acessórios pretendidos e a sua distribuição. Estas combinações estão sujeitas a indicações e possíveis alterações. Várias conjugações significam mais de um **Driver Remoto Incluído**. A medida mínima para conjugações é de 560mm.

Capa Técnica

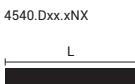

Lentes

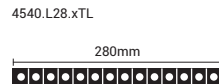

Nanos

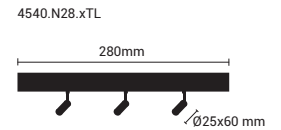
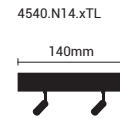
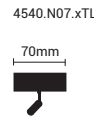

Pendentes

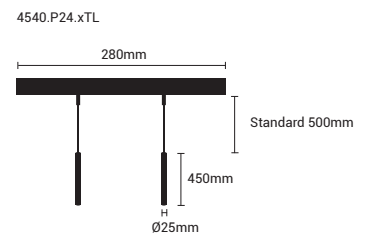
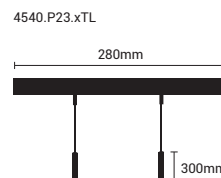
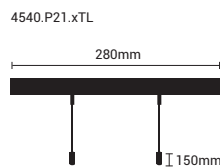
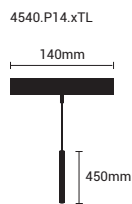
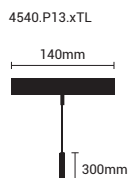
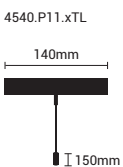

Exemplo de Conjugações

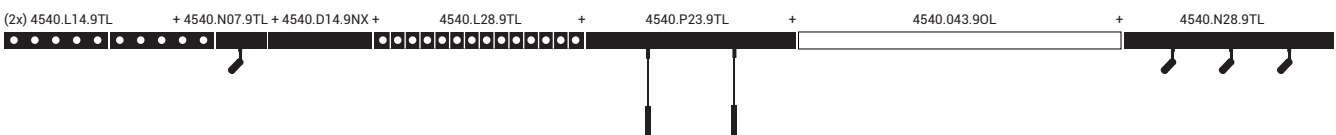

Opalino

código:
4x4x.xxx.xOL



Black

código:
4x4x.xxx.xBL





4046

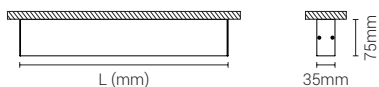

4046 | IK04 | IP40 | Módulo LED

Código	L (mm)	Fluxo/Pot. (aprox. 183lm/W)	HF (€)	1-10V (€)	DALI (€)
			4046	4146	4246
4046.029.xxL	290	1100 lm	41,44	-	-
4046.043.xxL	430	1650 lm	50,91	-	-
4046.057.xxL	570	2200 lm	55,79	88,34	86,48
4046.071.xxL	710	2750 lm	73,89	97,81	95,96
4046.085.xxL	850	3300 lm	80,92	104,84	102,99
4046.099.xxL	990	3850 lm	90,39	114,31	112,46
4046.113.xxL	1130	4400 lm	95,27	119,20	117,34
4046.127.xxL	1270	4950 lm	104,90	129,13	126,81
4046.141.xxL	1410	5500 lm	111,93	136,16	133,84
4046.155.xxL	1550	6050 lm	121,40	145,63	143,32
4046.169.xxL	1690	6600 lm	126,28	150,52	148,20
4046.183.xxL	1830	7150 lm	135,76	159,99	157,67
4046.197.xxL	1970	7700 lm	142,79	167,02	164,70
4046.211.xxL	2110	8250 lm	152,51	176,74	174,42
4046.225.xxL	2250	8800 lm	157,39	181,62	179,30
4046.239.xxL	2390	9350 lm	179,69	228,80	213,81
4046.253.xxL	2530	9900 lm	186,72	235,83	220,84
4046.267.xxL	2670	10450 lm	196,19	245,31	230,32
4046.281.xxL	2810	11000 lm	201,07	250,65	235,20
4046.295.xxL	2950	11550 lm	210,55	260,59	244,67
4046.309.xxL	3090	12100 lm	217,58	267,62	251,70
4046.323.xxL	3230	12650 lm	227,05	277,09	261,17
4046.337.xxL	3370	13200 lm	231,93	281,97	266,06
4046.351.xxL	3510	13750 lm	253,09	293,08	295,31
4046.365.xxL	3650	14300 lm	260,12	300,12	302,34
4046.379.xxL	3790	14850 lm	269,59	309,59	311,81
4046.393.xxL	3930	15400 lm	274,47	314,47	316,70
4046.407.xxL	4070	15950 lm	283,95	323,94	326,17
4046.421.xxL	4210	16500 lm	290,98	330,97	333,20
4046.435.xxL	4350	17050 lm	300,45	340,45	342,67
4046.449.xxL	4490	17600 lm	305,33	345,33	347,55
4046.463.xxL	4630	18150 lm	327,63	392,51	382,06
4046.477.xxL	4770	18700 lm	334,66	400,00	389,09
4046.491.xxL	4910	19250 lm	344,13	409,48	398,57
4046.505.xxL	5050	19800 lm	349,02	414,36	403,45

2700K | 3000K | 4000K | 5000K | 6500K



1

Branco

código:
4x46.xxx.1xL

2

Cinza

código:
4x46.xxx.2xL

3

Cinza Satinado

código:
4x46.xxx.3xL

4

Escovado

código:
4x46.xxx.4xL

7

Grafite

código:
4x46.xxx.7xL

9

Preto

código:
4x46.xxx.9xL

0

RAL sob Consulta

Podem ser instalados em linhas contínuas, com a forma e comprimento solicitados. Possibilidade de conjugar diferentes acessórios. Veja como, na página seguinte.



4046 Acessórios				
Código	L (mm)	Cor Acabamento	Fluxo/Pot. (aprox.)	HF (€)
4046.D14.xNX	140	Branco Preto	-	3,94
4046.D28.xNX	280	Branco Preto	-	6,42
4046.D56.xNX	560	Branco Preto	-	12,83
4046.D12.xNX	1120	Branco Preto	-	23,15
4046.L14.xTL	140	Branco Preto	5W - 700 lm	71,99
4046.L28.xTL	285	Branco Preto	12W - 1700 lm	125,30
4046.N14.xTL	140	Cor	3.5W - 500 lm	69,75
4046.N28.xTL	280	Cor	(2x) 3.5W - 500 lm	110,42
4046.P11.xTL	140	Cor	3.5W - 500 lm	69,75
4046.P13.xTL	140	Cor	3.5W - 500 lm	77,75
4046.P14.xTL	140	Cor	3.5W - 500 lm	85,75
4046.P21.xTL	280	Cor	(2x) 3.5W - 500 lm	129,50
4046.P23.xTL	280	Cor	(2x) 3.5W - 500 lm	145,50
4046.P24.xTL	280	Cor	(2x) 3.5W - 500 lm	161,50

As conjugações e a quantidade de módulos são definidas pelo cliente quando encomendadas, acrescentando, ao código do perfil, os códigos dos acessórios pretendidos e a sua distribuição. Estas combinações estão sujeitas a indicações e possíveis alterações. A medida mínima para conjugações é de 560mm.

Capa Técnica

4046.Dxx.xNX



Lentes

4046.L14.xTL

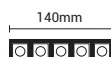

4046.L28.xTL



Nanos

4046.N14.xTL

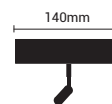

4046.N28.xTL

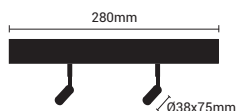

Pendentes

4046.P11.xTL

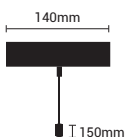

4046.P13.xTL

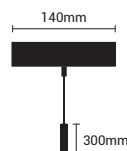

4046.P14.xTL

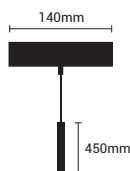

4046.P21.xTL

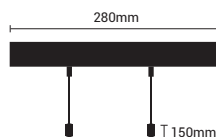

4046.P23.xTL

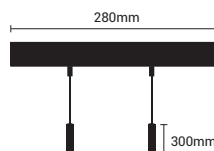

4046.P24.xTL

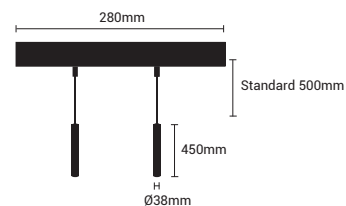

Exemplo de Conjugações

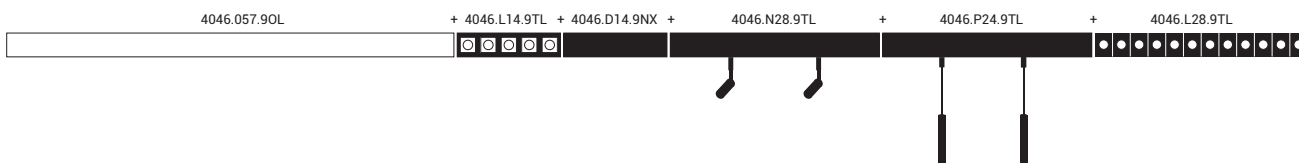

Opalino

código:
4x46.xxx.xOL



Prismático

código:
4x46.xxx.xPL



Black

código:
4x46.xxx.xBL





4041

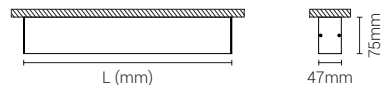

4041 IK05 IP40 Módulo LED					
Código	L (mm)	Fluxo/Pot. (aprox. 183lm/W)	HF (€)		
			4041	1-10V (€)	DALI (€)
4041.029.xxL	290	1100 lm	43,57	-	-
4041.043.xxL	430	1650 lm	53,89	-	-
4041.057.xxL	570	2200 lm	59,63	92,17	90,32
4041.071.xxL	710	2750 lm	78,58	102,50	100,64
4041.085.xxL	850	3300 lm	86,46	110,38	108,53
4041.099.xxL	990	3850 lm	96,78	120,71	118,85
4041.113.xxL	1130	4400 lm	102,52	126,44	124,59
4041.127.xxL	1270	4950 lm	113,00	137,23	134,91
4041.141.xxL	1410	5500 lm	120,88	145,11	142,80
4041.155.xxL	1550	6050 lm	131,21	155,44	153,12
4041.169.xxL	1690	6600 lm	136,94	161,17	158,86
4041.183.xxL	1830	7150 lm	147,27	171,50	169,18
4041.197.xxL	1970	7700 lm	155,15	179,38	177,06
4041.211.xxL	2110	8250 lm	165,72	189,95	187,64
4041.225.xxL	2250	8800 lm	171,46	195,69	193,37
4041.239.xxL	2390	9350 lm	194,61	243,72	228,73
4041.253.xxL	2530	9900 lm	202,49	251,61	236,61
4041.267.xxL	2670	10450 lm	212,82	261,93	246,94
4041.281.xxL	2810	11000 lm	218,55	268,13	252,67
4041.295.xxL	2950	11550 lm	228,88	278,92	263,00
4041.309.xxL	3090	12100 lm	236,76	286,80	270,88
4041.323.xxL	3230	12650 lm	247,08	297,13	281,21
4041.337.xxL	3370	13200 lm	252,82	302,86	286,94
4041.351.xxL	3510	13750 lm	274,83	314,82	317,05
4041.365.xxL	3650	14300 lm	282,71	322,71	324,93
4041.379.xxL	3790	14850 lm	293,03	333,03	335,26
4041.393.xxL	3930	15400 lm	298,77	338,77	340,99
4041.407.xxL	4070	15950 lm	309,09	349,09	351,32
4041.421.xxL	4210	16500 lm	316,98	356,97	359,20
4041.435.xxL	4350	17050 lm	327,30	367,30	369,52
4041.449.xxL	4490	17600 lm	333,04	373,03	375,26
4041.463.xxL	4630	18150 lm	356,19	421,07	410,62
4041.477.xxL	4770	18700 lm	364,07	429,41	418,50
4041.491.xxL	4910	19250 lm	374,40	439,74	428,83
4041.505.xxL	5050	19800 lm	380,13	445,47	434,56

2700K | 3000K | 4000K | 5000K | 6500K

4041 - Difusor de Alumínio IK05 IP20 Módulo LED					
Código	L (mm)	Fluxo/Pot. (aprox. 183lm/W)	HF (€)		
			4041	1-10V (€)	DALI (€)
4041.057.xAL	565	2200 lm	79,67	112,22	110,37
4041.085.xAL	845	3300 lm	109,01	132,93	131,08
4041.113.xAL	1125	4400 lm	129,05	152,97	151,12
4041.141.xAL	1405	5500 lm	153,59	177,83	175,51

2700K | 3000K | 4000K | 5000K | 6500K

4041 - Calha Trifásica IK05 IP20			
Código	L (mm)	Sistema	€
4041.T10.xCX	1090	Calha Trifásica 1000 mm	66,76
4041.T20.xCX	2090	Calha Trifásica 2000 mm	121,91
4041.T30.xCX	3090	Calha Trifásica 3000 mm	177,85

4041 Curvas IK05 IP40 Módulo LED							
Código	Raio Int. (mm)	Raio Ext. (mm)	Ângulo (°)	Fluxo/Pot. (aprox. 183lm/W)	HF (€)		
					4041	1-10V (€)	DALI (€)
4041.C59.xOL	520,5	567,5	90	3300 lm	174,64	198,56	196,71
4041.C54.xOL	520,5	567,5	45	1650 lm	97,98	-	-
4041.C69.xOL	620,5	667,5	90	3850 lm	184,96	208,89	207,03
4041.C79.xOL	720,5	767,5	90	4400 lm	190,70	214,62	212,77
4041.C74.xOL	720,5	767,5	45	2200 lm	103,72	136,26	134,41
4041.C89.xOL	820,5	867,5	90	4950 lm	201,18	225,41	223,09
4041.C99.xOL	920,5	967,5	90	5500 lm	209,06	233,29	230,98
4041.C94.xOL	920,5	967,5	45	2750 lm	122,67	146,59	144,73
4041.C19.xOL	1045,5	1092,5	90	6600 lm	225,12	249,35	247,04
4041.C14.xOL	1045,5	1092,5	45	3300 lm	130,55	154,47	152,62
4041.C29.xOL	1245,5	1292,5	90	7700 lm	243,33	267,56	265,24
4041.C24.xOL	1245,5	1292,5	45	3850 lm	140,87	164,80	162,94

2700K | 3000K | 4000K | 5000K | 6500K

Curvas

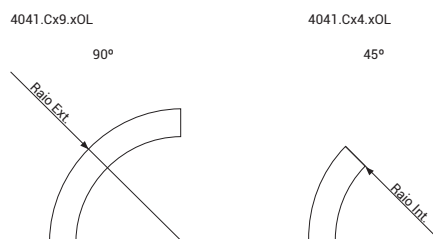

Exemplo de Conjugações

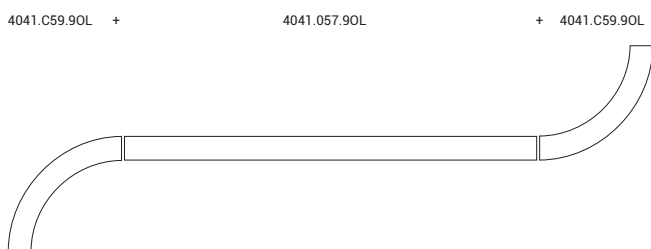

As conjugações e a quantidade de curvas são definidas pelo cliente quando encomendadas, acrescentando, ao código do perfil, os códigos dos perfis curvos pretendidos e a sua distribuição. Estas combinações estão sujeitas a indicações e possíveis alterações. O difusor das curvas é sempre opalino.



1

Branco

código:
4x41.xxx.1xL

2

Cinza

código:
4x41.xxx.2xL

3

Cinza Satinado

código:
4x41.xxx.3xL

4

Escovado

código:
4x41.xxx.4xL

7

Grafite

código:
4x41.xxx.7xL

9

Preto

código:
4x41.xxx.9xL

0

RAL sob Consulta

Podem ser instalados em linhas contínuas, com a forma e comprimento solicitados. Possibilidade de conjugar diferentes acessórios. Veja como, na página seguinte.



4041 Acessórios				
Código	L (mm)	Cor Acabamento	Fluxo/Pot. (aprox.)	HF (€)
4041.D14.xNX	140	Branco Preto	-	4,69
4041.D28.xNX	280	Branco Preto	-	7,32
4041.D56.xNX	560	Branco Preto	-	14,69
4041.D12.xNX	1120	Branco Preto	-	23,88
4041.L28.xTL	280	Branco Preto	7,7W - 1300 lm	88,35
4041.L18.xTL	180	Metalizado	5W - 700 lm	72,45
4041.N14.xTL	140	Cor	8,6W - 1350 lm	79,53
4041.N28.xTL	280	Cor	(2x) 8,6W - 1350 lm	110,25
4041.P11.xTL	140	Cor	8,6W - 1350 lm	79,53
4041.P13.xTL	140	Cor	8,6W - 1350 lm	88,53
4041.P14.xTL	140	Cor	8,6W - 1350 lm	96,53
4041.P21.xTL	280	Cor	(2x) 8,6W - 1350 lm	149,06
4041.P23.xTL	280	Cor	(2x) 8,6W - 1350 lm	167,06
4041.P24.xTL	280	Cor	(2x) 8,6W - 1350 lm	183,06

As conjugações e a quantidade de módulos são definidas pelo cliente quando encomendadas, acrescentando, ao código do perfil, os códigos dos acessórios pretendidos e a sua distribuição. Estas combinações estão sujeitas a indicações e possíveis alterações. A medida mínima para conjugações é de 560mm.

Capa Técnica

4041.Dxx.xNX



Lentes

4041.L28.xTL

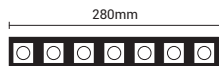

4041.L18.xTL

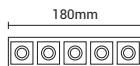

Nanos

4041.N14.xTL

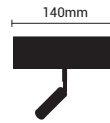

4041.N28.xTL

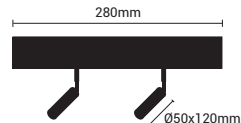

Pendentes

4041.P11.xTL

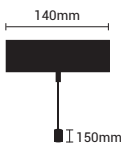

4041.P13.xTL

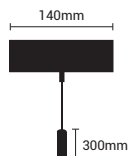

4041.P14.xTL

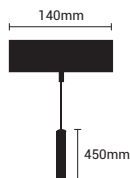

4041.P21.xTL

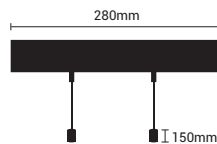

4041.P23.xTL

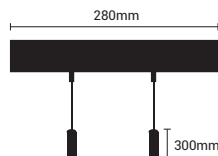

4041.P24.xTL

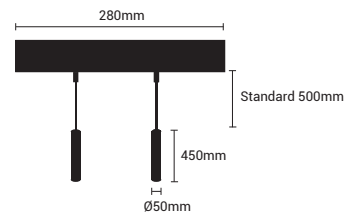

Exemplo de Conjugações

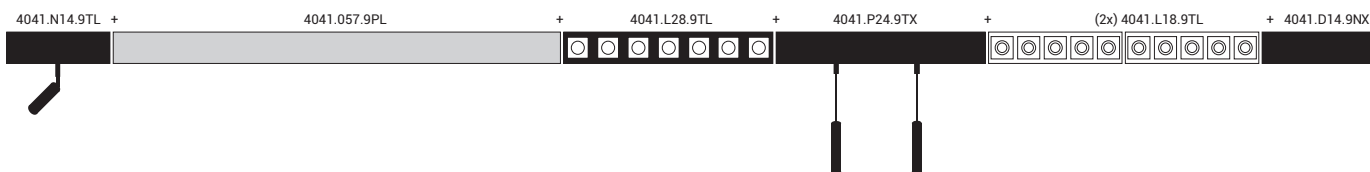

Opalino

código:
4x41.xxx.xOL



Prismático

código:
4x41.xxx.xPL



Alumínio

código:
4x41.xxx.xAL



Calha Trifásica

código:
4041.xxx.xCX



Black

código:
4x41.xxx.xBL



81,29€

104,78€

Estas luminárias podem incluir estes componentes eléctricos a partir de 1130mm.





4042



Esta referência tem a possibilidade da versão em 3R.

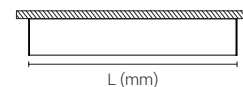

4042 | IK05 | IP40 | Módulo LED

Código	L (mm)	Fluxo/Pot. (aprox. 183lm/W)	HF (€)		
			4042	1-10V (€) 4142	DALI (€) 4242
4042.029.xxL	290	1100 lm	44,29	-	-
4042.043.xxL	430	1650 lm	54,91	-	-
4042.057.xxL	570	2200 lm	60,93	93,48	91,62
4042.071.xxL	710	2750 lm	80,17	104,09	102,24
4042.085.xxL	850	3300 lm	88,34	112,27	110,41
4042.099.xxL	990	3850 lm	98,96	122,88	121,03
4042.113.xxL	1130	4400 lm	104,98	128,91	127,05
4042.127.xxL	1270	4950 lm	115,75	139,98	137,67
4042.141.xxL	1410	5500 lm	123,93	148,16	145,84
4042.155.xxL	1550	6050 lm	134,54	158,77	156,45
4042.169.xxL	1690	6600 lm	140,56	164,80	162,48
4042.183.xxL	1830	7150 lm	151,18	175,41	173,09
4042.197.xxL	1970	7700 lm	159,35	183,59	181,27
4042.211.xxL	2110	8250 lm	170,21	194,45	192,13
4042.225.xxL	2250	8800 lm	176,24	200,47	198,15
4042.239.xxL	2390	9350 lm	199,68	248,80	233,81
4042.253.xxL	2530	9900 lm	207,85	256,97	241,98
4042.267.xxL	2670	10450 lm	218,47	267,58	252,59
4042.281.xxL	2810	11000 lm	224,49	274,07	258,62
4042.295.xxL	2950	11550 lm	235,11	285,15	269,23
4042.309.xxL	3090	12100 lm	243,28	293,32	277,41
4042.323.xxL	3230	12650 lm	253,90	303,94	288,02
4042.337.xxL	3370	13200 lm	259,92	309,96	294,04
4042.351.xxL	3510	13750 lm	282,22	322,22	324,44
4042.365.xxL	3650	14300 lm	290,39	330,39	332,61
4042.379.xxL	3790	14850 lm	301,01	341,00	343,23
4042.393.xxL	3930	15400 lm	307,03	347,03	349,25
4042.407.xxL	4070	15950 lm	317,65	357,64	359,87
4042.421.xxL	4210	16500 lm	325,82	365,82	368,04
4042.435.xxL	4350	17050 lm	336,43	376,43	378,66
4042.449.xxL	4490	17600 lm	342,46	382,46	384,68
4042.463.xxL	4630	18150 lm	365,90	430,78	420,33
4042.477.xxL	4770	18700 lm	374,07	439,42	428,51
4042.491.xxL	4910	19250 lm	384,69	450,03	439,12
4042.505.xxL	5050	19800 lm	390,71	456,06	445,15

2700K | 3000K | 4000K | 5000K | 6500K

4042 - Difusor de Alumínio | IK05 | IP20 | Módulo LED

Código	L (mm)	Fluxo/Pot. (aprox. 183lm/W)	HF (€)		
			4042	1-10V (€) 4142	DALI (€) 4242
4042.057.xAL	565	2200 lm	72,87	105,42	103,56
4042.085.xAL	845	3300 lm	103,88	127,81	125,95
4042.113.xAL	1125	4400 lm	127,99	151,91	150,06
4042.141.xAL	1405	5500 lm	163,98	188,21	185,90

2700K | 3000K | 4000K | 5000K | 6500K

4042 - 3R | IK05 | IP40 | Módulo LED

Código	L (mm)	Fluxo/Pot. (aprox.)	HF (€)	
			4042	DALI (€) 4242
4042.212.xLL	574	23W - 3700 lm	114,56	124,87
4042.312.xLL	861	35W - 5550 lm	145,93	159,06
4042.412.xLL	1148	46W - 7400 lm	177,04	192,97
4042.512.xLL	1435	58W - 9250 lm	197,35	214,53
4042.217.xLL	574	35W - 5090 lm	120,29	131,12
4042.317.xLL	861	52W - 7635 lm	153,23	167,02
4042.417.xLL	1148	70W - 10180 lm	185,89	202,62
4042.517.xLL	1435	87W - 12725 lm	207,23	225,87

2700K | 3000K | 4000K



1

Branco

código:
4x4x.xxx.1xL

2

Cinza

código:
4x4x.xxx.2xL

3

Cinza Satinado

código:
4x4x.xxx.3xL

4

Escovado

código:
4x4x.xxx.4xL

7

Grafite

código:
4x4x.xxx.7xL

9

Preto

código:
4x4x.xxx.9xL

0

RAL sob Consulta

Podem ser instalados em linhas contínuas, com a forma e comprimento solicitados.

4042 | Curvas | IK05 | IP40 | Módulo LED

Código	Raio Int. (mm)	Raio Ext. (mm)	Ângulo (°)	Fluxo/Pot. (aprox. 183lm/W)	HF (€)		
					4042	1-10V (€) 4142	DALI (€) 4242
4042.C59.xOL	520	585	90	3300 lm	176,52	200,45	198,59
4042.C54.xOL	520	585	45	1650 lm	99,00	-	-
4042.C69.xOL	620	685	90	3850 lm	187,11	211,06	209,21
4042.C79.xOL	720	785	90	4400 lm	193,16	217,09	215,23
4042.C74.xOL	720	785	45	2200 lm	105,02	137,57	135,71
4042.C89.xOL	820	885	90	4950 lm	203,93	228,16	225,85
4042.C99.xOL	920	985	90	5500 lm	212,11	236,34	234,02
4042.C94.xOL	920	985	45	2750 lm	124,26	148,18	146,33
4042.C19.xOL	1045	1110	90	6600 lm	228,74	252,98	250,66
4042.C14.xOL	1045	1110	45	3300 lm	132,43	156,36	154,50
4042.C29.xOL	1245	1310	90	7700 lm	247,53	271,77	269,45
4042.C24.xOL	1245	1310	45	3850 lm	143,05	166,97	165,12

2700K | 3000K | 4000K | 5000K | 6500K

Curvas

4042.Cx9.xOL

90°

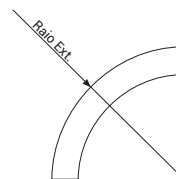

4042.Cx4.xOL

45°

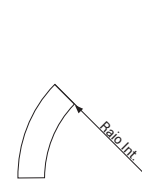

Exemplo de Conjugações

4042.C59.90L + 4042.057.90L + 4042.C59.90L

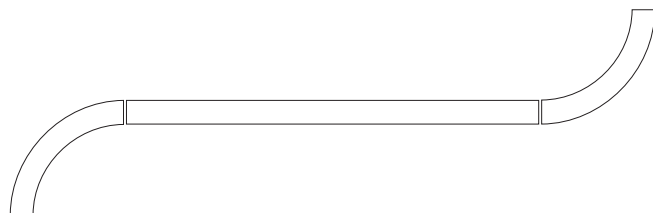

As conjugações e a quantidade de curvas são definidas pelo cliente quando encomendadas, acrescentando, ao código do perfil, os códigos dos perfis curvos pretendidos e a sua distribuição. Estas combinações estão sujeitas a indicações e possíveis alterações. O difusor das curvas é sempre opalino.



4043

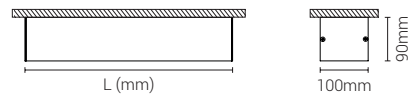

4043 | IK05 | IP40 | Módulo LED

Código	L (mm)	Fluxo/Pot. (aprox. 183lm/W)	Preço (€)		
			4043	1-10V (4143)	DALI (4243)
4043.029.xxL	290	1100 lm	51,94	-	-
4043.043.xxL	430	1650 lm	64,25	-	-
4043.057.xxL	570	2200 lm	71,98	104,53	102,67
4043.071.xxL	710	2750 lm	92,92	116,84	114,99
4043.085.xxL	850	3300 lm	102,79	126,72	124,86
4043.099.xxL	990	3850 lm	115,11	139,03	137,18
4043.113.xxL	1130	4400 lm	122,83	146,76	144,90
4043.127.xxL	1270	4950 lm	135,30	159,54	157,22
4043.141.xxL	1410	5500 lm	145,18	169,41	167,09
4043.155.xxL	1550	6050 lm	157,49	181,73	179,41
4043.169.xxL	1690	6600 lm	165,22	189,45	187,13
4043.183.xxL	1830	7150 lm	177,53	201,77	199,45
4043.197.xxL	1970	7700 lm	187,41	211,64	209,32
4043.211.xxL	2110	8250 lm	201,02	225,25	222,93
4043.225.xxL	2250	8800 lm	208,75	232,98	230,66
4043.239.xxL	2390	9350 lm	233,89	283,00	268,01
4043.253.xxL	2530	9900 lm	243,76	292,88	277,89
4043.267.xxL	2670	10450 lm	256,08	305,19	290,20
4043.281.xxL	2810	11000 lm	263,80	313,38	297,93
4043.295.xxL	2950	11550 lm	276,12	326,16	310,24
4043.309.xxL	3090	12100 lm	285,99	336,03	320,12
4043.323.xxL	3230	12650 lm	298,31	348,35	332,43
4043.337.xxL	3370	13200 lm	306,03	356,07	340,16
4043.351.xxL	3510	13750 lm	331,08	371,08	373,30
4043.365.xxL	3650	14300 lm	340,96	380,95	383,18
4043.379.xxL	3790	14850 lm	353,27	393,27	395,49
4043.393.xxL	3930	15400 lm	361,00	400,99	403,22
4043.407.xxL	4070	15950 lm	373,31	413,31	415,53
4043.421.xxL	4210	16500 lm	383,19	423,18	425,41
4043.435.xxL	4350	17050 lm	395,50	435,50	437,72
4043.449.xxL	4490	17600 lm	403,23	443,22	445,45
4043.463.xxL	4630	18150 lm	428,37	493,25	482,80
4043.477.xxL	4770	18700 lm	438,24	503,59	492,67
4043.491.xxL	4910	19250 lm	450,56	515,90	504,99
4043.505.xxL	5050	19800 lm	458,28	523,63	512,72

2700K | 3000K | 4000K | 5000K | 6500K

4043 - Difusor de Alumínio | IK05 | IP20 | Módulo LED

Código	L (mm)	Fluxo/Pot. (aprox. 183lm/W)	Preço (€)		
			4043	1-10V (4143)	DALI (4243)
4043.057.xAL	565	2200 lm	87,13	119,67	117,82
4043.085.xAL	845	3300 lm	118,34	142,26	140,41
4043.113.xAL	1125	4400 lm	138,78	162,70	160,85
4043.141.xAL	1405	5500 lm	169,53	193,76	191,44
4043.257.xAL	565	4400 lm	110,16	142,73	140,88
4043.285.xAL	845	6600 lm	151,39	175,41	173,56
4043.211.xAL	1125	8800 lm	177,98	201,90	200,05
4043.215.xAL	1405	11000 lm	199,78	271,06	268,74

2700K | 3000K | 4000K | 5000K | 6500K



Opalino

código:
4x4x.xxx.xOL

Prismático

código:
4x4x.xxx.xPL

Alumínio

código:
4x4x.xxx.xAL

3R

código:
4042.xxx.xLL

Black

código:
4x42.xxx.xBLKIT EMG
1H

81,29€

KIT EMG
3H

104,78€



Estas luminárias podem incluir estes componentes elétricos a partir de 1130mm.



4550 | 4551

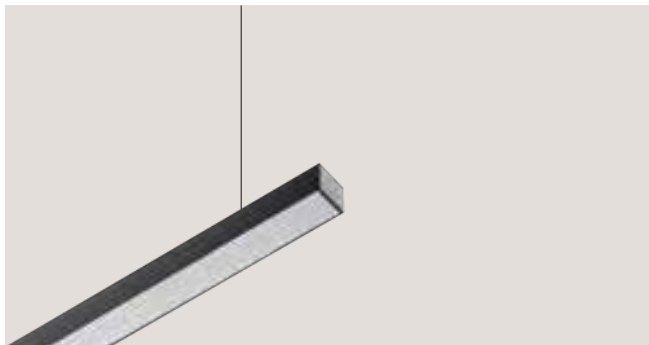

Informação Importante: Driver Remoto Incluído
(não integrado na luminária)

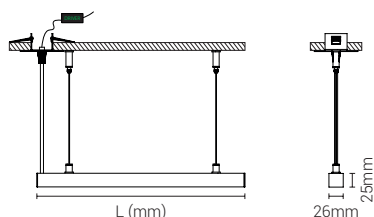

4550 IK04 IP40 Módulo LED					
Código	L (mm)	Fluxo/Pot. (aprox. 184lm/W)	HF (€)		DALI (€)
			4550	1-10V (€) 4650	4750
4550.015.xxL	150	490 lm	39,83	-	-
4550.029.xxL	290	980 lm	44,39	-	-
4550.043.xxL	430	1470 lm	51,08	-	-
4550.057.xxL	570	1960 lm	54,45	84,90	85,15
4550.071.xxL	710	2450 lm	69,92	91,59	91,84
4550.085.xxL	850	2940 lm	74,48	96,15	96,40
4550.099.xxL	990	3430 lm	81,17	102,84	103,09
4550.113.xxL	1130	3920 lm	84,54	106,21	106,46
4550.127.xxL	1270	4410 lm	91,23	112,90	113,15
4550.141.xxL	1410	4900 lm	95,79	120,03	117,71
4550.155.xxL	1550	5390 lm	102,61	126,84	124,52
4550.169.xxL	1690	5880 lm	105,98	130,21	127,89
4550.183.xxL	1830	6370 lm	112,67	136,90	134,58
4550.197.xxL	1970	6860 lm	117,23	141,46	139,14
4550.211.xxL	2110	7350 lm	123,92	148,15	145,84
4550.225.xxL	2250	7840 lm	127,29	151,52	149,20
4550.239.xxL	2390	8330 lm	133,98	158,21	155,90
4550.253.xxL	2530	8820 lm	138,54	162,77	160,46
4550.267.xxL	2670	9310 lm	145,23	205,54	167,15
4550.281.xxL	2810	9800 lm	148,60	208,91	170,52
4550.295.xxL	2950	10290 lm	155,29	215,60	177,21
4550.309.xxL	3090	10780 lm	159,85	222,72	181,77
4550.323.xxL	3230	11270 lm	167,29	230,16	189,20
4550.337.xxL	3370	11760 lm	183,48	233,52	217,61
4550.351.xxL	3510	12250 lm	190,17	240,22	224,30

2700K | 3000K | 4000K | 5000K | 6500K

4551 IK04 IP40 Fita LED				
Código	L (mm)	Fluxo/Pot. (aprox. 138lm/W)	HF (€)	
			4551	4751
4551.051.xxL	510	750 lm	53,37	104,15
4551.061.xxL	610	900 lm	57,84	108,62
4551.071.xxL	710	1050 lm	62,30	113,09
4551.081.xxL	810	1200 lm	66,77	117,55
4551.091.xxL	910	1350 lm	71,24	122,02
4551.101.xxL	1010	1500 lm	75,70	126,49
4551.111.xxL	1110	1650 lm	80,17	130,95
4551.121.xxL	1210	1800 lm	84,64	135,42
4551.131.xxL	1310	1950 lm	89,10	139,89
4551.141.xxL	1410	2100 lm	93,57	144,35
4551.151.xxL	1510	2250 lm	98,03	148,82
4551.161.xxL	1610	2400 lm	102,50	153,28
4551.171.xxL	1710	2550 lm	106,97	157,75
4551.181.xxL	1810	2700 lm	111,43	162,22
4551.191.xxL	1910	2850 lm	115,90	166,68
4551.201.xxL	2010	3000 lm	120,37	171,15
4551.211.xxL	2110	3150 lm	124,83	175,62
4551.221.xxL	2210	3300 lm	129,30	180,08
4551.231.xxL	2310	3450 lm	133,77	184,55
4551.241.xxL	2410	3600 lm	138,23	189,02
4551.251.xxL	2510	3750 lm	142,70	193,48
4551.261.xxL	2610	3900 lm	147,16	197,95
4551.271.xxL	2710	4050 lm	151,63	202,41
4551.281.xxL	2810	4200 lm	176,96	222,52
4551.291.xxL	2910	4350 lm	181,43	226,99
4551.301.xxL	3010	4500 lm	185,89	231,45

2700K | 3000K | 4000K | 6500K | RGB sob consulta

1-10V sob consulta.

4551 IK04 IP65 Driver IP20 Fita LED				
Código	L (mm)	Fluxo/Pot. (aprox. 83,2lm/W)	HF (€)	
			4551	4751
4551.052.xxL	520	610 lm	54,92	105,70
4551.062.xxL	620	732 lm	59,69	110,48
4551.072.xxL	720	854 lm	64,47	115,25
4551.082.xxL	820	976 lm	69,24	120,03
4551.092.xxL	920	1098 lm	74,02	124,80
4551.102.xxL	1020	1220 lm	78,79	129,58
4551.112.xxL	1120	1342 lm	83,57	134,35
4551.122.xxL	1220	1464 lm	88,34	139,13
4551.132.xxL	1320	1586 lm	93,12	143,90
4551.142.xxL	1420	1708 lm	97,90	148,68
4551.152.xxL	1520	1830 lm	102,67	153,45
4551.162.xxL	1620	1952 lm	107,45	158,23
4551.172.xxL	1720	2074 lm	112,22	163,01
4551.182.xxL	1820	2196 lm	117,00	167,78
4551.192.xxL	1920	2318 lm	121,77	172,55
4551.202.xxL	2020	2440 lm	126,55	177,33
4551.212.xxL	2120	2562 lm	131,32	182,11
4551.222.xxL	2220	2684 lm	136,10	186,88
4551.232.xxL	2320	2806 lm	140,87	191,66
4551.242.xxL	2420	2928 lm	145,65	196,43
4551.252.xxL	2520	3050 lm	150,43	201,21
4551.262.xxL	2620	3172 lm	155,20	205,98
4551.272.xxL	2720	3294 lm	159,98	210,76
4551.282.xxL	2820	3416 lm	185,62	231,18
4551.292.xxL	2920	3538 lm	190,39	235,95
4551.302.xxL	3020	3660 lm	195,17	240,73

2700K | 3000K | 4000K | 6000K | RGB sob consulta

1-10V sob consulta.

Acessórios		1 2 7 9		
Standard/Incluído	Opção			
5084.FER.xXX 5184.FER.xXX Floraço Encastrado Redondo 4550: Ø55mm 4551: Ø80mm	5084.FEQ.xXX 5184.FEQ.xXX Floraço Encastrado Quadrado 4550: 50x50mm 8,87€ 4551: 80x80mm 9,45€	5084.CDR.xXX Caixa para Driver 16,97€	5084.COS.xXX Cabos de Suspensão Standard/Incluído 1,5 m 5084.xAx.xXX Cabo de Alimentação Standard/Incluído 1,5 m Outras Medidas na Pág. 243	

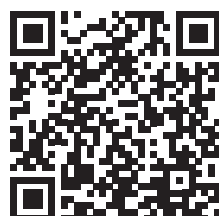
1
Brancocódigo:
4x5x.xxx.10L2
Cinzacódigo:
4x5x.xxx.20L3
Cinza Satinadocódigo:
4x5x.xxx.30L4
Escovadocódigo:
4x5x.xxx.40L7
Grafitecódigo:
4x5x.xxx.70L9
Pretocódigo:
4x5x.xxx.90L0
RAL sob Consulta

Podem ser instalados em linhas contínuas, com a forma e comprimento solicitados.
No perfil 4550 Módulo LED IP40, é possível conjugar diferentes acessórios. Veja como, na página seguinte.



4550 Acessórios				
Código	L (mm)	Cor Acabamento	Flow/Power (approx.)	HF (€)
4550.D14.xNX	140	Branco Preto	-	3,72
4550.D28.xNX	280	Branco Preto	-	6,07
4550.D56.xNX	560	Branco Preto	-	10,88
4550.D12.xNX	1120	Branco Preto	-	18,44
4550.L14.xTL	140	Branco Preto	5W - 700 lm	69,70
4550.L28.xTL	280	Branco Preto	6.5W - 1000 lm	104,65
4550.N07.xTL	70	Cor	1W - 140 lm	59,75
4550.N14.xTL	140	Cor	(2x) 1W - 140 lm	99,35
4550.N28.xTL	280	Cor	(3x) 1W - 140 lm	147,85
4550.P11.xTL	140	Cor	1W - 140 lm	59,75
4550.P13.xTL	140	Cor	1W - 140 lm	66,75
4550.P14.xTL	140	Cor	1W - 140 lm	73,75
4550.P21.xTL	280	Cor	(2x) 1W - 140 lm	114,50
4550.P23.xTL	280	Cor	(2x) 1W - 140 lm	123,50
4550.P24.xTL	280	Cor	(2x) 1W - 140 lm	137,50

As conjugações e a quantidade de módulos são definidas pelo cliente quando encomendadas, acrescentando, ao código do perfil, os códigos dos acessórios pretendidos e a sua distribuição. Estas combinações estão sujeitas a indicações e possíveis alterações. Várias conjugações significam mais de um **Driver Remoto Incluído**. A medida mínima para conjugações é de 560mm.

Capa Técnica

4550.Dxx.xNX



Lentes

4550.L14.xTL



4550.L28.xTL



Nanos

4550.N07.xTL



4550.N14.xTL

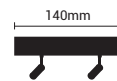

4550.N28.xTL

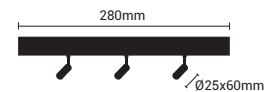

Pendentes

4550.P11.xTL

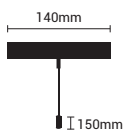

4550.P13.xTL

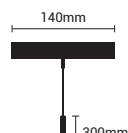

4550.P14.xTL

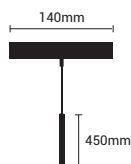

4550.P21.xTL

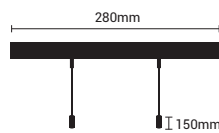

4550.P23.xTL

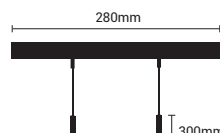

4550.P24.xTL

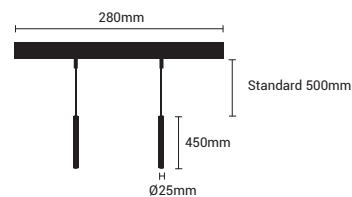

Exemplo de Conjugações

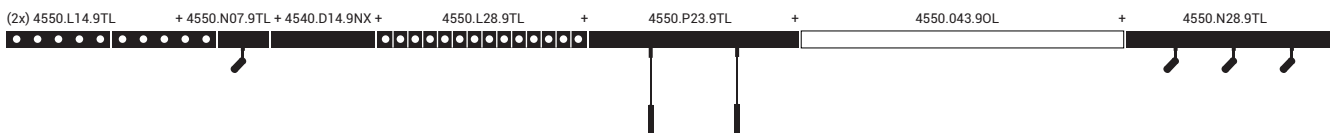

Opalino

código:
4x5x.xxx.xOL



Black

código:
4x5x.xxx.xBL





4556

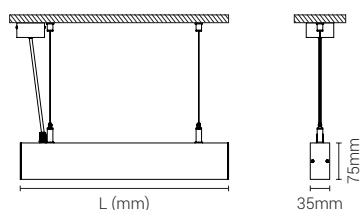
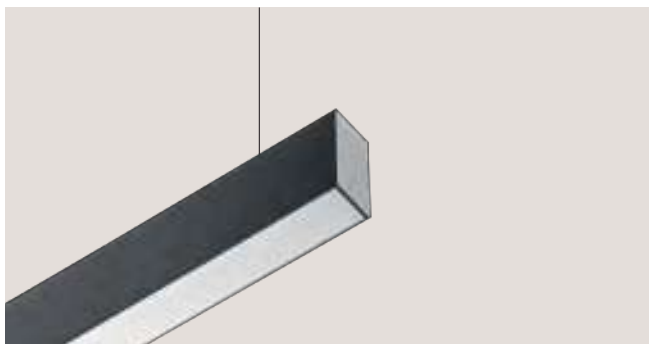

4556 IK04 IP40 Módulo LED					
Código	L (mm)	Fluxo/Pot. (aprox. 183lm/W)	HF (€) 4556	1-10V (€) 4656	DALI (€) 4756
4556.029.xxL	290	1100 lm	53,18	-	-
4556.043.xxL	430	1650 lm	62,65	-	-
4556.057.xxL	570	2200 lm	67,54	100,08	98,23
4556.071.xxL	710	2750 lm	85,63	109,56	107,70
4556.085.xxL	850	3300 lm	92,66	116,59	114,73
4556.099.xxL	990	3850 lm	102,14	126,06	124,20
4556.113.xxL	1130	4400 lm	107,02	130,94	129,09
4556.127.xxL	1270	4950 lm	116,64	140,88	138,56
4556.141.xxL	1410	5500 lm	123,68	147,91	145,59
4556.155.xxL	1550	6050 lm	133,15	157,38	155,06
4556.169.xxL	1690	6600 lm	138,03	162,26	159,94
4556.183.xxL	1830	7150 lm	147,50	171,74	169,42
4556.197.xxL	1970	7700 lm	154,53	178,77	176,45
4556.211.xxL	2110	8250 lm	164,25	188,49	186,17
4556.225.xxL	2250	8800 lm	169,14	193,37	191,05
4556.239.xxL	2390	9350 lm	191,43	240,55	225,56
4556.253.xxL	2530	9900 lm	198,47	247,58	232,59
4556.267.xxL	2670	10450 lm	207,94	257,05	242,06
4556.281.xxL	2810	11000 lm	212,82	262,40	246,94
4556.295.xxL	2950	11550 lm	228,29	278,33	262,41
4556.309.xxL	3090	12100 lm	235,32	285,36	269,44
4556.323.xxL	3230	12650 lm	244,79	294,83	278,92
4556.337.xxL	3370	13200 lm	249,67	299,72	283,80
4556.351.xxL	3510	13750 lm	270,83	310,83	313,05
4556.365.xxL	3650	14300 lm	277,86	317,86	320,08
4556.379.xxL	3790	14850 lm	287,33	327,33	329,56
4556.393.xxL	3930	15400 lm	292,22	332,21	334,44
4556.407.xxL	4070	15950 lm	301,69	341,68	343,91
4556.421.xxL	4210	16500 lm	308,72	348,72	350,94
4556.435.xxL	4350	17050 lm	318,19	358,19	360,41
4556.449.xxL	4490	17600 lm	323,07	363,07	365,30
4556.463.xxL	4630	18150 lm	345,37	410,25	399,80
4556.477.xxL	4770	18700 lm	352,40	417,75	406,83
4556.491.xxL	4910	19250 lm	361,88	427,22	416,31
4556.505.xxL	5050	19800 lm	366,76	432,10	421,19

2700K | 3000K | 4000K | 5000K | 6500K

Acessórios			
Standard/Incluído	Opção	Opção	Opção
5084.FSR.xXX Florão Saliente Redondo Ø58mm	5084.FSQ.xXX Florão Saliente Quadrado 58x58mm 9,36€	5084.FER.xXX Florão Encastrado Redondo Ø55mm 8,77€	5084.FEQ.xXX Florão Encastrado Quadrado 50x50mm 8,87€
5084.CDR.xXX Caixa para Driver 16,97€	5084.COS.xXX Cabos de Suspensão Standard/Incluído 1,5 metros	5084.xAX.xXX Cabo de Alimentação Standard/Incluído 1,5 metros Outras Medidas na Página 243	



1

Branco

código:
4x56.xxx.1xL

2

Cinza

código:
4x56.xxx.2xL

3

Cinza Satinado

código:
4x56.xxx.3xL

4

Escovado

código:
4x56.xxx.4xL

7

Grafite

código:
4x56.xxx.7xL

9

Preto

código:
4x56.xxx.9xL

0

RAL sob Consulta

Podem ser instalados em linhas contínuas, com a forma e comprimento solicitados. Possibilidade de conjugar diferentes acessórios. Veja como, na página seguinte.



4556 | Acessórios

Código	L (mm)	Cor Acabamento	Fluxo/Pot. (aprox.)	HF (€)
4556.D14.xNX	140	Branco Preto	-	3,94
4556.D28.xNX	280	Branco Preto	-	6,42
4556.D56.xNX	560	Branco Preto	-	12,83
4556.D12.xNX	1120	Branco Preto	-	23,15
4556.L14.xTL	140	Branco Preto	5W - 700 lm	71,99
4556.L28.xTL	285	Branco Preto	12W - 1700 lm	125,30
4556.N14.xTL	140	Cor	3.5W - 500 lm	69,75
4556.N28.xTL	280	Cor	(2x) 3.5W - 500 lm	110,42
4556.P11.xTL	140	Cor	3.5W - 500 lm	69,75
4556.P13.xTL	140	Cor	3.5W - 500 lm	77,75
4556.P14.xTL	140	Cor	3.5W - 500 lm	85,75
4556.P21.xTL	280	Cor	(2x) 3.5W - 500 lm	129,50
4556.P23.xTL	280	Cor	(2x) 3.5W - 500 lm	145,50
4556.P24.xTL	280	Cor	(2x) 3.5W - 500 lm	161,50

As conjugações e a quantidade de módulos são definidas pelo cliente quando encomendadas, acrescentando, ao código do perfil, os códigos dos acessórios pretendidos e a sua distribuição. Estas combinações estão sujeitas a indicações e possíveis alterações. A medida mínima para conjugações é de 560mm.

Capa Técnica

4556.Dxx.xNX



Lentes

4556.L14.xTL

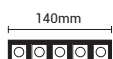

4556.L28.xTL



Nanos

4556.N14.xTL

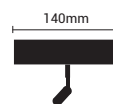

4556.N28.xTL

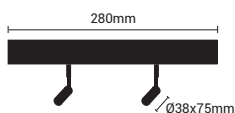

Pendentes

4556.P11.xTL

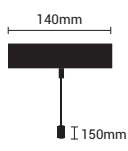

4556.P13.xTL

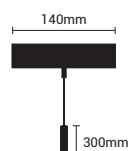

4556.P14.xTL

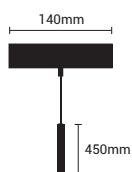

4556.P21.xTL

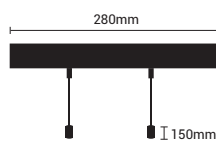

4556.P23.xTL



4556.P24.xTL

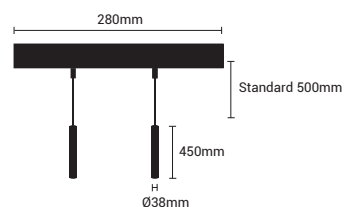

Exemplo de Conjugações

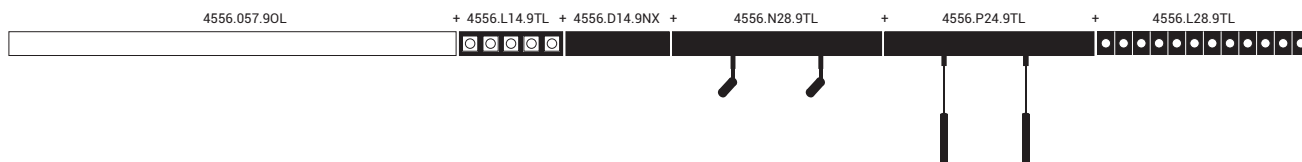

Opalino

código:
4x56.xxx.xOL



Prismático

código:
4x56.xxx.xPL



Black

código:
4x56.xxx.xBL





4051



4051 | IK05 | IP40 | Módulo LED

Código	L (mm)	Fluxo/Pot. (aprox. 183lm/W)	HF (€)		
			4051	1-10V (€) 4151	DALI (€) 4251
4051.029.xxL	290	1100 lm	55,31	-	-
4051.043.xxL	430	1650 lm	65,64	-	-
4051.057.xxL	570	2200 lm	71,37	103,92	102,07
4051.071.xxL	710	2750 lm	90,32	114,24	112,39
4051.085.xxL	850	3300 lm	98,20	122,13	120,27
4051.099.xxL	990	3850 lm	108,53	132,45	130,60
4051.113.xxL	1130	4400 lm	114,26	138,19	136,33
4051.127.xxL	1270	4950 lm	124,74	148,98	146,66
4051.141.xxL	1410	5500 lm	132,63	156,86	154,54
4051.155.xxL	1550	6050 lm	142,95	167,18	164,87
4051.169.xxL	1690	6600 lm	148,69	172,92	170,60
4051.183.xxL	1830	7150 lm	159,01	183,24	180,93
4051.197.xxL	1970	7700 lm	166,89	191,13	188,81
4051.211.xxL	2110	8250 lm	177,47	201,70	199,38
4051.225.xxL	2250	8800 lm	183,20	207,43	205,12
4051.239.xxL	2390	9350 lm	206,35	255,47	240,48
4051.253.xxL	2530	9900 lm	214,24	263,35	248,36
4051.267.xxL	2670	10450 lm	224,56	273,68	258,68
4051.281.xxL	2810	11000 lm	230,30	279,87	264,42
4051.295.xxL	2950	11550 lm	246,62	296,66	280,74
4051.309.xxL	3090	12100 lm	254,50	304,54	288,62
4051.323.xxL	3230	12650 lm	264,83	314,87	298,95
4051.337.xxL	3370	13200 lm	270,56	320,60	304,68
4051.351.xxL	3510	13750 lm	292,57	332,56	334,79
4051.365.xxL	3650	14300 lm	300,45	340,45	342,67
4051.379.xxL	3790	14850 lm	310,78	350,77	353,00
4051.393.xxL	3930	15400 lm	316,51	356,51	358,73
4051.407.xxL	4070	15950 lm	326,84	366,83	369,06
4051.421.xxL	4210	16500 lm	334,72	374,72	376,94
4051.435.xxL	4350	17050 lm	345,04	385,04	387,27
4051.449.xxL	4490	17600 lm	350,78	390,78	393,00
4051.463.xxL	4630	18150 lm	373,93	438,81	428,36
4051.477.xxL	4770	18700 lm	381,81	447,16	436,25
4051.491.xxL	4910	19250 lm	392,14	457,48	446,57
4051.505.xxL	5050	19800 lm	397,87	463,22	452,30

2700K | 3000K | 4000K | 5000K | 6500K

4051 - Difusor de Alumínio | IK05 | IP20 | Módulo LED

Código	L (mm)	Fluxo/Pot. (aprox. 183lm/W)	HF (€)		
			4051	1-10V (€) 4151	DALI (€) 4251
4051.057.xAL	565	2200 lm	91,42	123,97	122,11
4051.085.xAL	845	3300 lm	120,75	144,68	142,68
4051.113.xAL	1125	4400 lm	140,80	164,72	162,87
4051.141.xAL	1405	5500 lm	165,34	189,57	187,25

2700K | 3000K | 4000K | 5000K | 6500K

4051 - Calha Trifásica | IK05 | IP20

Código	L (mm)	Sistema	€
4051.T10.xCX	1090	Calha Trifásica 1000 mm	66,76
4051.T20.xCX	2090	Calha Trifásica 2000 mm	121,91
4051.T30.xCX	3090	Calha Trifásica 3000 mm	177,85

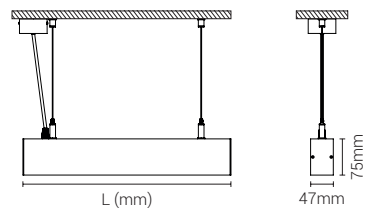

4051 | Curvas | IK05 | IP40 | Módulo LED

Código	Raio Int. (mm)	Raio Ext. (mm)	Ângulo (°)	Fluxo/Pot. (aprox. 183lm/W)	HF (€)		
					4051	1-10V (€) 4151	DALI (€) 4251
4051.C59.xOL	520,5	567,5	90	3300 lm	186,38	210,31	208,45
4051.C54.xOL	520,5	567,5	45	1650 lm	109,73	-	-
4051.C69.xOL	620,5	667,5	90	3850 lm	196,71	220,63	218,78
4051.C79.xOL	720,5	767,5	90	4400 lm	202,44	226,37	224,51
4051.C74.xOL	720,5	767,5	45	2200 lm	115,46	148,01	146,16
4051.C89.xOL	820,5	867,5	90	4950 lm	212,92	237,16	234,84
4051.C99.xOL	920,5	967,5	90	5500 lm	220,81	245,04	242,72
4051.C94.xOL	920,5	967,5	45	2750 lm	134,41	158,33	156,48
4051.C19.xOL	1045,5	1092,5	90	6600 lm	236,87	261,10	258,78
4051.C14.xOL	1045,5	1092,5	45	3300 lm	142,07	166,22	164,36
4051.C29.xOL	1245,5	1292,5	90	7700 lm	255,07	279,31	276,99
4051.C24.xOL	1245,5	1292,5	45	3850 lm	152,62	176,54	174,69

2700K | 3000K | 4000K | 5000K | 6500K

Curvas

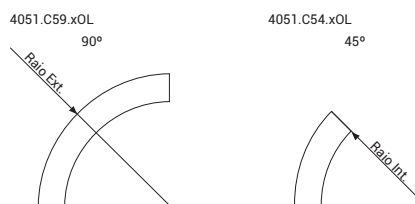

As conjugações e a quantidade de curvas são definidas pelo cliente quando encomendadas, acrescentando, ao código do perfil, os códigos dos perfis curvos pretendidos e a sua distribuição. Estas combinações estão sujeitas a indicações e possíveis alterações. O difusor das curvas é sempre opalino.

Acessórios

Standard/Incluído	Opção	Opção	Opção
5084.FSR.xXX Florão Saliente Redondo Ø58mm	5084.FSQ.xXX Florão Saliente Quadrado 58x58mm 9,36€	5084.FER.xXX Florão Encastrado Redondo Ø55mm 8,77€	5084.FEQ.xXX Florão Encastrado Quadrado 50x50mm 8,87€
5084.CDR.xXX Caixa para Driver 16,97€	5084.COS.xXX Cabos de Suspensão Standard/Incluído 1,5m	5084.xAx.xXX Cabo de Alimentação Standard/Incluído 1,5m	Outras Medidas na Página 243



1

Branco

código:
4x51.xxx.1xL

2

Cinza

código:
4x51.xxx.2xL

3

Cinza Satinado

código:
4x51.xxx.3xL

4

Escovado

código:
4x51.xxx.4xL

7

Grafite

código:
4x51.xxx.7xL

9

Preto

código:
4x51.xxx.9xL

0

RAL sob Consulta

Podem ser instalados em linhas contínuas, com a forma e comprimento solicitados. Possibilidade de conjugar diferentes acessórios. Veja como, na página seguinte.



4051 Acessórios				
Código	L (mm)	Cor Acabamento	Flow/Power (approx.)	HF (€)
4051.D14.xNX	140	Branco Preto	-	4,69
4051.D28.xNX	280	Branco Preto	-	7,32
4051.D56.xNX	560	Branco Preto	-	14,69
4051.D12.xNX	1120	Branco Preto	-	23,88
4051.L28.xTL	280	Branco Preto	7,7W - 1300 lm	88,35
4051.L18.xTL	180	Metalizado	5W - 700 lm	72,45
4051.N14.xTL	140	Cor	8,6W - 1350 lm	79,53
4051.N28.xTL	280	Cor	(2x) 8,6W - 1350 lm	110,25
4051.P11.xTL	140	Cor	8,6W - 1350 lm	79,53
4051.P13.xTL	140	Cor	8,6W - 1350 lm	88,53
4051.P14.xTL	140	Cor	8,6W - 1350 lm	96,53
4051.P21.xTL	280	Cor	(2x) 8,6W - 1350 lm	149,06
4051.P23.xTL	280	Cor	(2x) 8,6W - 1350 lm	167,06
4051.P24.xTL	280	Cor	(2x) 8,6W - 1350 lm	183,06

As conjugações e a quantidade de módulos são definidas pelo cliente quando encomendadas, acrescentando, ao código do perfil, os códigos dos acessórios pretendidos e a sua distribuição. Estas combinações estão sujeitas a indicações e possíveis alterações. A medida mínima para conjugações é de 560mm.

Capa Técnica

4051.Dxx.xNX



Lentes

4051.L28.xTL

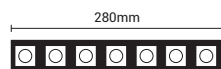

4051.L18.xTL

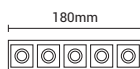

Nanos

4051.N14.xTL

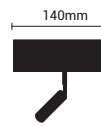

4051.N28.xTL

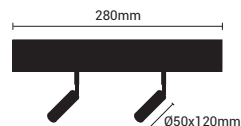

Pendentes

4051.P11.xTL

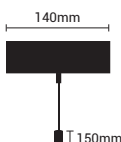

4051.P13.xTL

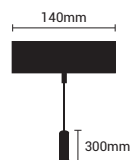

4051.P14.xTL

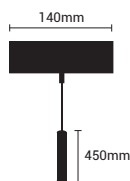

4051.P21.xTL

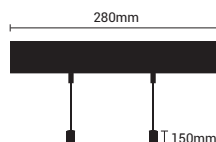

4051.P23.xTL

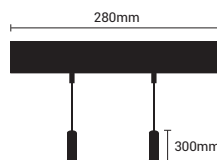

4051.P24.xTL

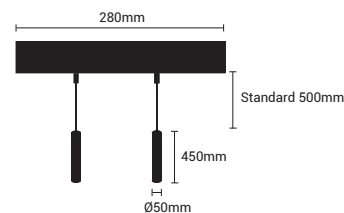

Exemplo de Conjugações

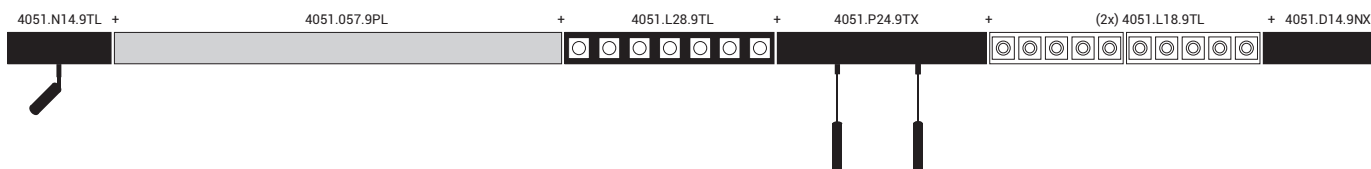

Opalino

código:
4x51.xxx.xOL



Prismático

código:
4x51.xxx.xPL



Alumínio

código:
4x51.xxx.xAL



Calha Trifásica

código:
4051.xxx.xCX



Black

código:
4x51.xxx.xBL



81,29€



104,78€



Estas luminárias podem incluir estes componentes eléctricos a partir de 1130mm.



4052

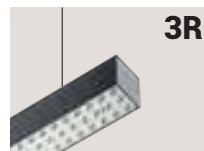

Esta referência tem a possibilidade da versão em 3R.

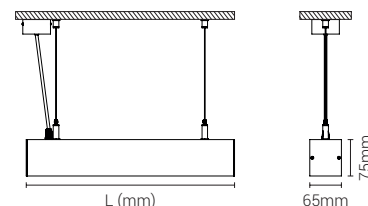

4052 IK05 IP40 Módulo LED					
Código	L (mm)	Fluxo/Pot. (aprox. 183lm/W)	HF (€) 4052	1-10V (€) 4152	DALI (€) 4252
4052.029.xxL	290	1100 lm	56,04	-	-
4052.043.xxL	430	1650 lm	66,65	-	-
4052.057.xxL	570	2200 lm	72,68	105,22	103,37
4052.071.xxL	710	2750 lm	91,92	115,84	113,98
4052.085.xxL	850	3300 lm	100,09	124,01	122,16
4052.099.xxL	990	3850 lm	110,70	134,63	132,77
4052.113.xxL	1130	4400 lm	116,73	140,65	138,80
4052.127.xxL	1270	4950 lm	127,50	151,73	149,41
4052.141.xxL	1410	5500 lm	135,67	159,90	157,59
4052.155.xxL	1550	6050 lm	146,29	170,52	168,20
4052.169.xxL	1690	6600 lm	152,31	176,54	174,22
4052.183.xxL	1830	7150 lm	162,92	187,16	184,84
4052.197.xxL	1970	7700 lm	171,10	195,33	193,01
4052.211.xxL	2110	8250 lm	181,96	206,19	203,87
4052.225.xxL	2250	8800 lm	187,98	212,22	209,90
4052.239.xxL	2390	9350 lm	211,43	260,54	245,55
4052.253.xxL	2530	9900 lm	219,60	268,71	253,72
4052.267.xxL	2670	10450 lm	230,21	279,33	264,34
4052.281.xxL	2810	11000 lm	236,24	285,82	270,36
4052.295.xxL	2950	11550 lm	252,85	302,89	286,97
4052.309.xxL	3090	12100 lm	261,02	311,07	295,15
4052.323.xxL	3230	12650 lm	271,64	321,68	305,76
4052.337.xxL	3370	13200 lm	277,66	327,70	311,79
4052.351.xxL	3510	13750 lm	299,96	339,96	342,18
4052.365.xxL	3650	14300 lm	308,13	348,13	350,36
4052.379.xxL	3790	14850 lm	318,75	358,75	360,97
4052.393.xxL	3930	15400 lm	324,77	364,77	367,00
4052.407.xxL	4070	15950 lm	335,39	375,39	377,61
4052.421.xxL	4210	16500 lm	343,56	383,56	385,78
4052.435.xxL	4350	17050 lm	354,18	394,17	396,40
4052.449.xxL	4490	17600 lm	360,20	400,20	402,42
4052.463.xxL	4630	18150 lm	383,64	448,52	438,07
4052.477.xxL	4770	18700 lm	391,82	457,16	446,25
4052.491.xxL	4910	19250 lm	402,43	467,77	456,86
4052.505.xxL	5050	19800 lm	408,46	473,80	462,89

2700K | 3000K | 4000K | 5000K | 6500K

4052 - Difusor de Alumínio IK05 IP20 Módulo LED					
Código	L (mm)	Fluxo/Pot. (aprox. 183lm/W)	HF (€) 4052	1-10V (€) 4152	DALI (€) 4252
4052.057.xAL	565	2200 lm	84,62	117,16	115,31
4052.085.xAL	845	3300 lm	115,63	139,55	137,70
4052.113.xAL	1125	4400 lm	139,74	163,66	161,81
4052.141.xAL	1405	5500 lm	175,73	199,96	197,64

2700K | 3000K | 4000K | 5000K | 6500K

4052 - 3R IK05 IP40 Módulo LED				
Código	L (mm)	Fluxo/Pot. (aprox.)	HF (€) 4052	DALI (€) 4252
4052.212.xLL	574	23W - 3700 lm	121,73	132,04
4052.312.xLL	861	35W - 5550 lm	153,93	166,23
4052.412.xLL	1148	46W - 7400 lm	184,21	200,14
4052.512.xLL	1435	58W - 9250 lm	204,52	221,70
4052.217.xLL	574	35W - 5090 lm	127,46	138,29
4052.317.xLL	861	52W - 7635 lm	160,40	174,19
4052.417.xLL	1148	70W - 10180 lm	193,06	209,79
4052.517.xLL	1435	87W - 12725 lm	214,40	233,04

2700K | 3000K | 4000K

4052 Curvas IK05 IP40 Módulo LED							
Código	Raio Int. (mm)	Raio Ext. (mm)	Ângulo (°)	Fluxo/Pot. (aprox. 183lm/W)	HF (€) 4052	1-10V (€) 4152	DALI (€) 4252
4052.C59.xOL	520	585	90	3300 lm	188,27	212,19	210,34
4052.C54.xOL	520	585	45	1650 lm	110,74	-	-
4052.C69.xOL	620	685	90	3850 lm	198,88	222,81	220,95
4052.C79.xOL	720	785	90	4400 lm	204,91	228,83	226,98
4052.C74.xOL	720	785	45	2200 lm	116,09	149,31	147,46
4052.C89.xOL	820	885	90	4950 lm	215,68	239,91	237,59
4052.C99.xOL	920	985	90	5500 lm	223,85	248,08	245,77
4052.C94.xOL	920	985	45	2750 lm	136,01	159,93	158,07
4052.C19.xOL	1045	1110	90	6600 lm	240,49	264,72	262,40
4052.C14.xOL	1045	1110	45	3300 lm	144,18	168,10	166,25
4052.C29.xOL	1245	1310	90	7700 lm	259,28	283,51	281,19
4052.C24.xOL	1245	1310	45	3850 lm	154,79	178,72	176,86

2700K | 3000K | 4000K | 5000K | 6500K

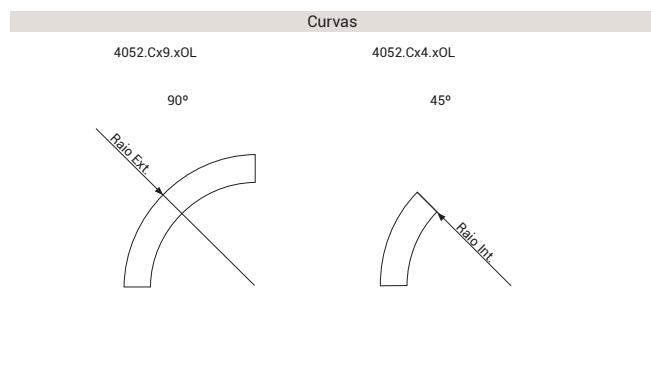

Exemplo de Conjugações

4052.C59.90L + 4052.057.90L + 4052.C54.90L

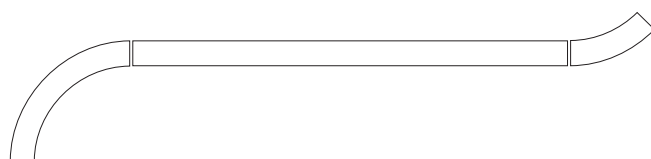

As conjugações e a quantidade de curvas são definidas pelo cliente quando encomendadas, acrescentando, ao código do perfil, os códigos dos perfis curvos pretendidos e a sua distribuição. Estas combinações estão sujeitas a indicações e possíveis alterações. O difusor das curvas é sempre opalino.



1

Branco

código:
4x5x.xxx.1xL

2

Cinza

código:
4x5x.xxx.2xL

3

Cinza Satinado

código:
4x5x.xxx.3xL

4

Escovado

código:
4x5x.xxx.4xL

7

Grafite

código:
4x5x.xxx.7xL

9

Preto

código:
4x5x.xxx.9xL

0

RAL sob Consulta

Podem ser instalados em linhas contínuas, com a forma e comprimento solicitados. Possibilidade de conjugar diferentes acessórios. Veja como, na página seguinte.



4053

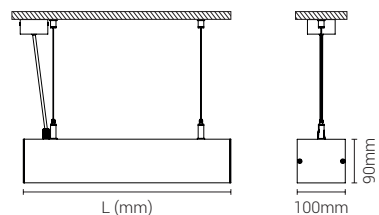

4053 | IK05 | IP40 | Módulo LED

Código	L (mm)	Fluxo/Pot. (aprox. 183lm/W)	HF (€) 4053	1-10V (€) 4153	DALI (€) 4253
4053.029.xxL	290	1100 lm	63,68	-	-
4053.043.xxL	430	1650 lm	76,00	-	-
4053.057.xxL	570	2200 lm	83,73	116,27	114,42
4053.071.xxL	710	2750 lm	104,66	128,59	126,73
4053.085.xxL	850	3300 lm	114,54	138,46	136,61
4053.099.xxL	990	3850 lm	126,85	150,78	148,92
4053.113.xxL	1130	4400 lm	134,58	158,50	156,65
4053.127.xxL	1270	4950 lm	147,05	171,28	168,96
4053.141.xxL	1410	5500 lm	156,92	181,16	178,84
4053.155.xxL	1550	6050 lm	169,24	193,47	191,15
4053.169.xxL	1690	6600 lm	176,96	201,20	198,88
4053.183.xxL	1830	7150 lm	189,28	213,51	211,19
4053.197.xxL	1970	7700 lm	199,15	223,38	221,07
4053.211.xxL	2110	8250 lm	212,77	237,00	234,68
4053.225.xxL	2250	8800 lm	220,49	244,72	242,41
4053.239.xxL	2390	9350 lm	245,63	294,75	279,76
4053.253.xxL	2530	9900 lm	255,51	304,62	289,63
4053.267.xxL	2670	10450 lm	267,82	316,94	301,95
4053.281.xxL	2810	11000 lm	275,55	325,13	309,67
4053.295.xxL	2950	11550 lm	293,86	343,90	327,98
4053.309.xxL	3090	12100 lm	303,73	353,78	337,86
4053.323.xxL	3230	12650 lm	316,05	366,09	350,17
4053.337.xxL	3370	13200 lm	323,77	373,82	357,90
4053.351.xxL	3510	13750 lm	348,82	388,82	391,05
4053.365.xxL	3650	14300 lm	358,70	398,69	400,92
4053.379.xxL	3790	14850 lm	371,01	411,01	413,24
4053.393.xxL	3930	15400 lm	378,74	418,74	420,96
4053.407.xxL	4070	15950 lm	391,05	431,05	433,28
4053.421.xxL	4210	16500 lm	400,93	440,92	443,15
4053.435.xxL	4350	17050 lm	413,24	453,24	455,47
4053.449.xxL	4490	17600 lm	420,97	460,97	463,19
4053.463.xxL	4630	18150 lm	446,11	510,99	500,54
4053.477.xxL	4770	18700 lm	455,99	521,33	510,42
4053.491.xxL	4910	19250 lm	468,30	533,64	522,73
4053.505.xxL	5050	19800 lm	476,03	541,37	530,46

2700K | 3000K | 4000K | 5000K | 6500K

4053 - Difusor de Alumínio | IK05 | IP20 | Módulo LED

Código	L (mm)	Fluxo/Pot. (aprox. 183lm/W)	HF (€) 4053	1-10V (€) 4153	DALI (€) 4253
4053.057.xAL	565	2200 lm	98,87	131,42	129,57
4053.085.xAL	845	3300 lm	130,08	154,01	152,15
4053.113.xAL	1125	4400 lm	150,53	174,45	172,59
4053.141.xAL	1405	5500 lm	181,27	205,51	203,19
4053.257.xAL	565	4400 lm	121,90	154,47	152,62
4053.285.xAL	845	6600 lm	163,13	187,15	185,30
4053.211.xAL	1125	8800 lm	189,72	213,64	211,79
4053.215.xAL	1405	11000 lm	211,52	282,80	280,48

2700K | 3000K | 4000K | 5000K | 6500K

Acessórios

1 2 7 9

Standard/Incluído	Opção	Opção	Opção
			Outras Medidas na Página 243



Opalino

código:
4x5x.xxx.xOL

Prismático

código:
4x5x.xxx.xPL

Alumínio

código:
4x5x.xxx.xAL

3R

código:
4x52.xxx.xLL

Black

código:
4x52.xxx.xBLKIT EMG
1HKIT EMG
3H

81,29€

104,78€



Estas luminárias podem incluir estes componentes elétricos a partir de 1130mm.



4566

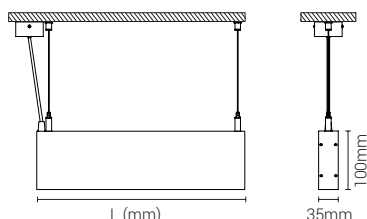

4060

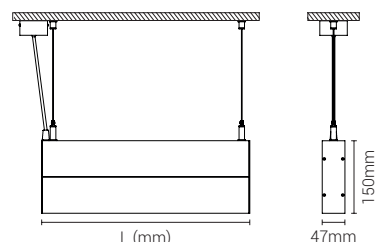

4566 IK04 IP40 Módulo LED					
Código	L (mm)	Fluxo/Pot. (aprox. 183lm/W)	HF (€) 4566	1-10V (€) 4666	DALI (€) 4766
4566.057.xxL	570	3300 lm	112,93	178,02	174,31
4566.071.xxL	710	4400 lm	146,81	194,66	190,95
4566.085.xxL	850	5500 lm	158,56	206,41	202,70
4566.099.xxL	990	6600 lm	175,19	223,04	219,33
4566.113.xxL	1130	7700 lm	182,65	230,50	226,79
4566.127.xxL	1270	8800 lm	199,59	248,06	243,42
4566.141.xxL	1410	9900 lm	211,34	259,81	255,17
4566.155.xxL	1550	11000 lm	227,98	276,44	271,81
4566.169.xxL	1690	12100 lm	235,43	283,90	279,26
4566.183.xxL	1830	13200 lm	252,06	300,53	295,89
4566.197.xxL	1970	14300 lm	263,81	312,28	307,64
4566.211.xxL	2110	15400 lm	280,94	329,41	324,77
4566.225.xxL	2250	16500 lm	288,40	336,86	332,23
4566.239.xxL	2390	17600 lm	330,69	428,91	398,93
4566.253.xxL	2530	18700 lm	342,44	440,67	410,68
4566.267.xxL	2670	19800 lm	359,07	457,30	427,32
4566.281.xxL	2810	20900 lm	366,52	465,68	434,77
4566.295.xxL	2950	22000 lm	389,15	489,24	457,40
4566.309.xxL	3090	23100 lm	400,91	500,99	469,15
4566.323.xxL	3230	24200 lm	417,54	517,62	485,79
4566.337.xxL	3370	25300 lm	424,99	525,08	493,24
4566.351.xxL	3510	25850 lm	464,99	544,99	549,44
4566.365.xxL	3650	26400 lm	476,74	556,74	561,19
4566.379.xxL	3790	28050 lm	493,38	573,37	577,82
4566.393.xxL	3930	28600 lm	500,83	580,83	585,28
4566.407.xxL	4070	29700 lm	517,47	597,46	601,91
4566.421.xxL	4210	31900 lm	529,22	609,21	613,66
4566.435.xxL	4350	32450 lm	545,85	625,84	630,30
4566.449.xxL	4490	33000 lm	553,31	633,30	637,75
4566.463.xxL	4630	34650 lm	595,59	725,35	704,46
4566.477.xxL	4770	35200 lm	607,34	738,03	716,21
4566.491.xxL	4910	35750 lm	623,98	754,66	732,84
4566.505.xxL	5050	36300 lm	631,43	762,12	740,29

2700K | 3000K | 4000K | 5000K | 6500K

4060 IK06 IP40 Módulo LED					
Código	L (mm)	Fluxo/Pot. (aprox. 183lm/W)	HF (€) 4060	1-10V (€) 4160	DALI (€) 4260
4060.057.xxL	570	3850 lm	131,00	196,09	192,38
4060.071.xxL	710	4950 lm	168,90	216,74	213,03
4060.085.xxL	850	6050 lm	184,66	232,51	228,80
4060.099.xxL	990	7150 lm	205,31	253,16	249,45
4060.113.xxL	1130	8250 lm	216,78	264,63	260,92
4060.127.xxL	1270	9350 lm	237,74	286,21	281,57
4060.141.xxL	1410	10450 lm	253,51	301,97	297,34
4060.155.xxL	1550	11550 lm	274,16	322,62	317,99
4060.169.xxL	1690	12650 lm	285,63	334,09	329,46
4060.183.xxL	1830	13750 lm	306,28	354,74	350,11
4060.197.xxL	1970	14850 lm	322,04	370,51	365,87
4060.211.xxL	2110	15950 lm	343,19	391,65	387,02
4060.225.xxL	2250	17050 lm	354,66	403,12	398,49
4060.239.xxL	2390	18150 lm	400,96	499,19	469,21
4060.253.xxL	2530	19250 lm	416,73	514,96	484,97
4060.267.xxL	2670	20350 lm	437,38	535,61	505,62
4060.281.xxL	2810	21450 lm	448,85	548,00	517,09
4060.295.xxL	2950	22550 lm	475,49	575,58	543,74
4060.309.xxL	3090	23650 lm	491,26	591,34	559,51
4060.323.xxL	3230	24750 lm	511,91	611,99	580,16
4060.337.xxL	3370	25850 lm	523,38	623,46	591,63
4060.351.xxL	3510	26950 lm	567,40	647,39	651,84
4060.365.xxL	3650	27500 lm	583,16	663,15	667,60
4060.379.xxL	3790	29150 lm	603,81	683,80	688,25
4060.393.xxL	3930	29700 lm	615,28	695,27	699,72
4060.407.xxL	4070	31350 lm	635,93	715,92	720,37
4060.421.xxL	4210	31900 lm	651,70	731,69	736,14
4060.435.xxL	4350	33550 lm	672,35	752,34	756,79
4060.449.xxL	4490	34100 lm	683,82	763,81	768,26
4060.463.xxL	4630	35750 lm	730,12	859,88	838,98
4060.477.xxL	4770	36300 lm	745,89	876,57	854,75
4060.491.xxL	4910	37400 lm	766,54	897,22	875,40
4060.505.xxL	5050	37950 lm	778,01	908,69	886,87

2700K | 3000K | 4000K | 5000K | 6500K



1

Branco

código:
4x6x.xxx.1xL

2

Cinza

código:
4x6x.xxx.2xL

3

Cinza Satinado

código:
4x6x.xxx.3xL

4

Escovado

código:
4x6x.xxx.4xL

7

Grafite

código:
4x6x.xxx.7xL

9

Preto

código:
4x6x.xxx.9xL

0

RAL sob Consulta

Podem ser instalados em linhas contínuas, com a forma e comprimento solicitados.



4560

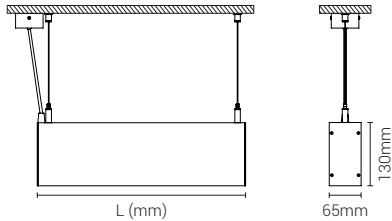

4061

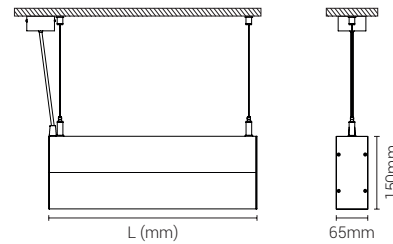
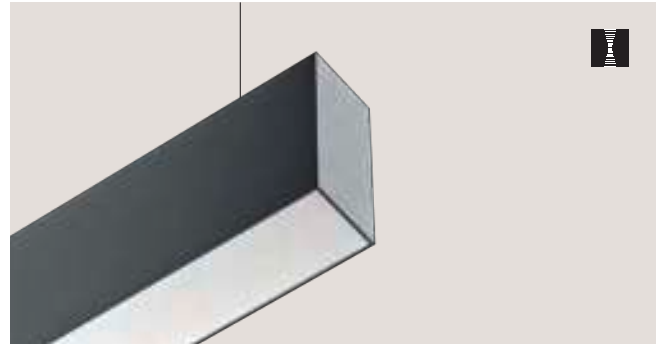

4560 IK06 IP40 Módulo LED					
Código	L (mm)	Fluxo/Pot. (aprox. 183lm/W)	HF (€) 4560	1-10V (€) 4660	DALI (€) 4760
4560.057.xxL	570	3850 lm	136,02	201,11	201,11
4560.071.xxL	710	4950 lm	174,50	223,27	223,27
4560.085.xxL	850	6050 lm	191,65	240,42	240,42
4560.099.xxL	990	7150 lm	213,80	262,58	262,58
4560.113.xxL	1130	8250 lm	225,61	274,38	274,38
4560.127.xxL	1270	9350 lm	246,53	297,46	297,46
4560.141.xxL	1410	10450 lm	263,68	314,61	314,61
4560.155.xxL	1550	11550 lm	285,83	336,77	336,77
4560.169.xxL	1690	12650 lm	297,63	348,57	348,57
4560.183.xxL	1830	13750 lm	319,79	370,73	370,73
4560.197.xxL	1970	14850 lm	336,94	387,88	387,88
4560.211.xxL	2110	15950 lm	359,59	410,53	410,53
4560.225.xxL	2250	17050 lm	371,39	422,33	422,33
4560.239.xxL	2390	18150 lm	421,37	519,91	487,76
4560.253.xxL	2530	19250 lm	438,52	537,06	504,91
4560.267.xxL	2670	20350 lm	460,68	559,21	527,07
4560.281.xxL	2810	21450 lm	472,48	571,94	538,87
4560.295.xxL	2950	22550 lm	500,63	601,02	567,02
4560.309.xxL	3090	23650 lm	517,78	618,17	584,17
4560.323.xxL	3230	24750 lm	539,94	640,33	606,33
4560.337.xxL	3370	25850 lm	551,74	652,13	618,13
4560.351.xxL	3510	26950 lm	592,63	677,57	691,29
4560.365.xxL	3650	27500 lm	609,78	694,72	708,44
4560.379.xxL	3790	29150 lm	631,94	716,87	730,60
4560.393.xxL	3930	29700 lm	643,74	728,68	742,40
4560.407.xxL	4070	31350 lm	665,89	750,83	764,56
4560.421.xxL	4210	31900 lm	683,04	767,98	781,71
4560.435.xxL	4350	33550 lm	705,20	790,14	803,86
4560.449.xxL	4490	34100 lm	717,00	801,94	815,66
4560.463.xxL	4630	35750 lm	766,98	899,52	881,09
4560.477.xxL	4770	36300 lm	784,13	917,59	898,24
4560.491.xxL	4910	37400 lm	806,28	939,75	920,40
4560.505.xxL	5050	37950 lm	818,09	951,55	932,20

2700K | 3000K | 4000K | 5000K | 6500K

4061 IK06 IP40 Módulo LED					
Código	L (mm)	Fluxo/Pot. (aprox. 183lm/W)	HF (€) 4061	1-10V (€) 4161	DALI (€) 4261
4061.057.xxL	570	3850 lm	138,19	203,28	203,28
4061.071.xxL	710	4950 lm	176,67	225,44	225,44
4061.085.xxL	850	6050 lm	193,82	242,59	242,59
4061.099.xxL	990	7150 lm	215,97	264,75	264,75
4061.113.xxL	1130	8250 lm	227,78	276,55	276,55
4061.127.xxL	1270	9350 lm	248,70	299,63	299,63
4061.141.xxL	1410	10450 lm	265,85	316,78	316,78
4061.155.xxL	1550	11550 lm	288,00	338,94	338,94
4061.169.xxL	1690	12650 lm	299,80	350,74	350,74
4061.183.xxL	1830	13750 lm	321,96	372,90	372,90
4061.197.xxL	1970	14850 lm	339,11	390,05	390,05
4061.211.xxL	2110	15950 lm	361,76	412,70	412,70
4061.225.xxL	2250	17050 lm	373,56	424,50	424,50
4061.239.xxL	2390	18150 lm	423,54	522,08	489,93
4061.253.xxL	2530	19250 lm	440,69	539,23	507,08
4061.267.xxL	2670	20350 lm	462,85	561,38	529,24
4061.281.xxL	2810	21450 lm	474,65	574,11	541,04
4061.295.xxL	2950	22550 lm	502,80	603,19	569,19
4061.309.xxL	3090	23650 lm	519,95	620,34	586,34
4061.323.xxL	3230	24750 lm	542,11	642,50	608,50
4061.337.xxL	3370	25850 lm	553,91	654,30	620,30
4061.351.xxL	3510	26950 lm	594,80	679,74	693,46
4061.365.xxL	3650	27500 lm	611,95	696,89	710,61
4061.379.xxL	3790	29150 lm	634,11	719,04	732,77
4061.393.xxL	3930	29700 lm	645,91	730,85	744,57
4061.407.xxL	4070	31350 lm	668,06	753,00	766,73
4061.421.xxL	4210	31900 lm	685,21	770,15	783,88
4061.435.xxL	4350	33550 lm	707,37	792,31	806,03
4061.449.xxL	4490	34100 lm	719,17	804,11	817,83
4061.463.xxL	4630	35750 lm	769,15	901,69	883,26
4061.477.xxL	4770	36300 lm	786,30	919,76	900,41
4061.491.xxL	4910	37400 lm	808,45	941,92	922,57
4061.505.xxL	5050	37950 lm	820,26	953,72	934,37

2700K | 3000K | 4000K | 5000K | 6500K

Acessórios

1 2 7 9

Standard/Incluído	Opção	Opção	Opção		
5084.FSR.xXX Florão Saliente Redondo Ø58mm	5084.FSQ.xXX Florão Saliente Quadrado 58x58mm 9,36€	5084.FER.xXX Florão Encastrado Redondo Ø55mm 8,77€	5084.FEQ.xXX Florão Encastrado Quadrado 50x50mm 8,87€	5084.CDR.xXX Caixa para Driver 16,97€	5084.COS.xXX Cabos de Suspensão Standard/Incluído 1,5 metros 5084.xAx.xXX Cabo de Alimentação Standard/Incluído 1,5 metros Outras Medidas na Página 243

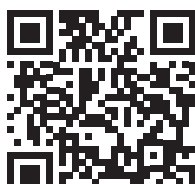

Opalino
código:
4x6x.xxx.x0L



Prismático
código:
4x6x.xxx.xPL



Black
código:
4x6x.xxx.xBL



81,29€



104,78€



Estas luminárias podem incluir estes componentes elétricos a partir de 1130mm.



4056

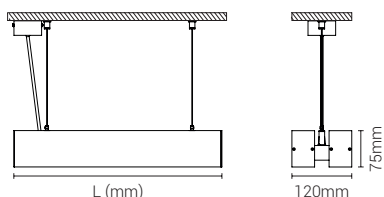
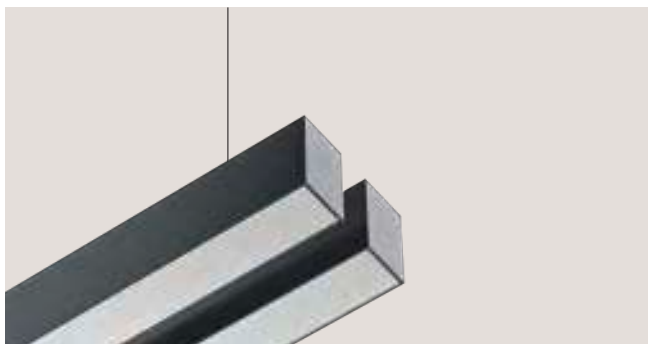

4057

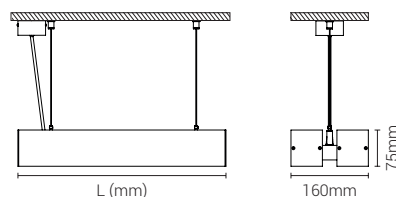
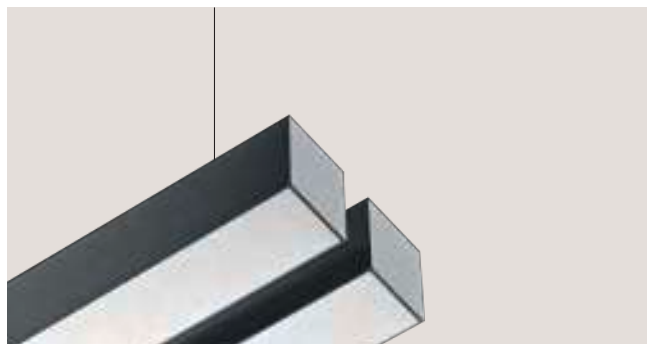

4056 | IK05 | IP40 | Módulo LED

Código	L (mm)	Fluxo/Pot. (aprox. 183lm/W)	HF (€)		1-10V (€)		DALI (€)	
			4056	4156	4156	4256	4256	4257
4056.057.xxL	570	4400 lm	133,17	198,26	198,26	198,26	198,26	198,26
4056.071.xxL	710	5500 lm	171,07	218,91	218,91	218,91	218,91	218,91
4056.085.xxL	850	6600 lm	186,83	234,68	234,68	234,68	234,68	234,68
4056.099.xxL	990	7700 lm	207,48	255,33	255,33	255,33	255,33	255,33
4056.113.xxL	1130	8800 lm	218,95	266,80	266,80	266,80	266,80	266,80
4056.127.xxL	1270	9900 lm	239,91	288,38	288,38	288,38	288,38	288,38
4056.141.xxL	1410	11000 lm	255,68	304,14	304,14	304,14	304,14	304,14
4056.155.xxL	1550	12100 lm	276,33	324,79	324,79	324,79	324,79	324,79
4056.169.xxL	1690	13200 lm	287,80	336,26	336,26	336,26	336,26	336,26
4056.183.xxL	1830	14300 lm	308,45	356,91	356,91	356,91	356,91	356,91
4056.197.xxL	1970	15400 lm	324,21	372,68	372,68	372,68	372,68	372,68
4056.211.xxL	2110	16500 lm	345,36	393,82	393,82	393,82	393,82	393,82
4056.225.xxL	2250	17600 lm	356,83	405,29	405,29	405,29	405,29	405,29
4056.239.xxL	2390	18700 lm	403,13	501,36	501,36	501,36	501,36	501,36
4056.253.xxL	2530	19800 lm	418,90	517,13	517,13	517,13	517,13	517,13
4056.267.xxL	2670	20900 lm	439,55	537,78	537,78	537,78	537,78	537,78
4056.281.xxL	2810	22000 lm	451,02	550,17	550,17	550,17	550,17	550,17
4056.295.xxL	2950	23100 lm	477,66	577,75	577,75	577,75	577,75	577,75
4056.309.xxL	3090	24200 lm	493,43	593,51	593,51	593,51	593,51	593,51
4056.323.xxL	3230	25300 lm	514,08	614,16	614,16	614,16	614,16	614,16
4056.337.xxL	3370	26400 lm	525,55	625,63	625,63	625,63	625,63	625,63
4056.351.xxL	3510	27500 lm	569,57	649,56	649,56	649,56	649,56	649,56
4056.365.xxL	3650	28600 lm	585,33	665,32	665,32	665,32	665,32	665,32
4056.379.xxL	3790	29700 lm	605,98	685,97	685,97	685,97	685,97	685,97
4056.393.xxL	3930	30800 lm	617,45	697,44	697,44	697,44	697,44	697,44
4056.407.xxL	4070	31900 lm	638,10	718,09	718,09	718,09	718,09	718,09
4056.421.xxL	4210	33000 lm	653,87	733,86	733,86	733,86	733,86	733,86
4056.435.xxL	4350	34100 lm	674,52	754,51	754,51	754,51	754,51	754,51
4056.449.xxL	4490	35200 lm	685,99	765,98	765,98	765,98	765,98	765,98
4056.463.xxL	4630	36300 lm	732,29	862,05	862,05	862,05	862,05	862,05
4056.477.xxL	4770	37400 lm	748,06	878,74	878,74	878,74	878,74	878,74
4056.491.xxL	4910	38500 lm	768,71	899,39	899,39	899,39	899,39	899,39
4056.505.xxL	5050	39600 lm	780,18	910,86	910,86	910,86	910,86	910,86

2700K | 3000K | 4000K | 5000K | 6500K

4057 | IK05 | IP40 | Módulo LED

Código	L (mm)	Fluxo/Pot. (aprox. 183lm/W)	HF (€)		1-10V (€)		DALI (€)	
			4057	4157	4157	4257	4257	4257
4057.057.xxL	570	4400 lm	140,36	205,45	205,45	205,45	205,45	205,45
4057.071.xxL	710	5500 lm	178,84	227,61	227,61	227,61	227,61	227,61
4057.085.xxL	850	6600 lm	195,99	244,76	244,76	244,76	244,76	244,76
4057.099.xxL	990	7700 lm	218,14	266,92	266,92	266,92	266,92	266,92
4057.113.xxL	1130	8800 lm	229,95	278,72	278,72	278,72	278,72	278,72
4057.127.xxL	1270	9900 lm	250,87	301,80	301,80	301,80	301,80	301,80
4057.141.xxL	1410	11000 lm	268,02	318,95	318,95	318,95	318,95	318,95
4057.155.xxL	1550	12100 lm	290,17	341,11	341,11	341,11	341,11	341,11
4057.169.xxL	1690	13200 lm	301,97	352,91	352,91	352,91	352,91	352,91
4057.183.xxL	1830	14300 lm	324,13	375,07	375,07	375,07	375,07	375,07
4057.197.xxL	1970	15400 lm	341,28	392,22	392,22	392,22	392,22	392,22
4057.211.xxL	2110	16500 lm	363,93	414,87	414,87	414,87	414,87	414,87
4057.225.xxL	2250	17600 lm	375,73	426,67	426,67	426,67	426,67	426,67
4057.239.xxL	2390	18700 lm	425,71	524,25	524,25	524,25	524,25	524,25
4057.253.xxL	2530	19800 lm	442,86	541,40	541,40	541,40	541,40	541,40
4057.267.xxL	2670	20900 lm	465,02	563,55	563,55	563,55	563,55	563,55
4057.281.xxL	2810	22000 lm	476,82	576,28	576,28	576,28	576,28	576,28
4057.295.xxL	2950	23100 lm	504,97	605,36	605,36	605,36	605,36	605,36
4057.309.xxL	3090	24200 lm	522,12	622,51	622,51	622,51	622,51	622,51
4057.323.xxL	3230	25300 lm	544,28	644,67	644,67	644,67	644,67	644,67
4057.337.xxL	3370	26400 lm	556,08	656,47	656,47	656,47	656,47	656,47
4057.351.xxL	3510	27500 lm	596,97	681,91	681,91	681,91	681,91	681,91
4057.365.xxL	3650	28600 lm	614,12	699,06	699,06	699,06	699,06	699,06
4057.379.xxL	3790	29700 lm	636,28	721,21	721,21	721,21	721,21	721,21
4057.393.xxL	3930	30800 lm	648,08	733,02	733,02	733,02	733,02	733,02
4057.407.xxL	4070	31900 lm	670,23	755,17	755,17	755,17	755,17	755,17
4057.421.xxL	4210	33000 lm	687,38	772,32	772,32	772,32	772,32	772,32
4057.435.xxL	4350	34100 lm	709,54	794,48	794,48	794,48	794,48	794,48
4057.449.xxL	4490	35200 lm	721,34	806,28	806,28	806,28	806,28	806,28
4057.463.xxL	4630	36300 lm	771,32	903,86	903,86	903,86	903,86	903,86
4057.477.xxL	4770	37400 lm	788,47	921,93	921,93	921,93	921,93	921,93
4057.491.xxL	4910	38500 lm	810,62	944,09	944,09	944,09	944,09	944,09
4057.505.xxL	5050	39600 lm	822,43	955,89	955,89	955,89	955,89	955,89

2700K | 3000K | 4000K | 5000K | 6500K

4056 - Difusor de Alumínio | IK05 | IP20 | Módulo LED

Código	L (mm)	Fluxo/Pot. (aprox. 183lm/W)	HF (€)		1-10V (€)		DALI (€)	
			4056	4156	4156	4256	4256	4257
4056.057.xAL	565	4400 lm	157,49	222,58	222,58	222,58	222,58	222,58
4056.085.xAL	845	6600 lm	219,51	267,36	267,36	267,36	267,36	267,36
4056.113.xAL	1125	8800 lm	267,73	315,57	315,57	315,57	315,57	315,57
4056.141.xAL	1405	11000 lm	339,71	388,17	388,17	388,17	388,17	388,17

2700K | 3000K | 4000K | 5000K | 6500K

4057 - Difusor de Alumínio | IK05 | IP20 | Módulo LED

Código	L (mm)	Fluxo/Pot. (aprox. 183lm/W)	HF (€)		1-10V (€)		DALI (€)	
			4057	4157	4157	4257	4257	4257
4057.057.xAL	565	4400 lm	171,09	236,19	236,19	236,19	236,19	236,19
4057.085.xAL	845	6600 lm	229,79	277,61	277,61	277,61	277,61	277,61
4057.113.xAL	1125	8800 lm	269,85	317,69	317,69	317,69	317,69	317,69
4057.141.xAL	1405	11000 lm	318,93	367,40	367,40	367,40	367,40	367,40

2700K | 3000K | 4000K | 5000K | 6500K



1

Branco

código:
4xxx.xxx.1xL

2

Cinza

código:
4xxx.xxx.2xL

3

Cinza Satinado

código:
4xxx.xxx.3xL

4

Escovado

código:
4xxx.xxx.4xL

7

Grafite

código:
4xxx.xxx.7xL

9

Preto

código:
4xxx.xxx.9xL

0

RAL sob Consulta

Podem ser instalados em linhas contínuas, com a forma e comprimento solicitados.



4062

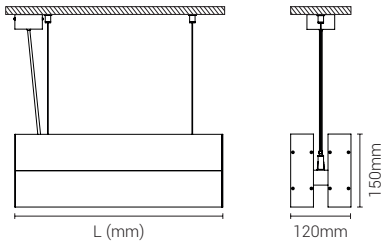
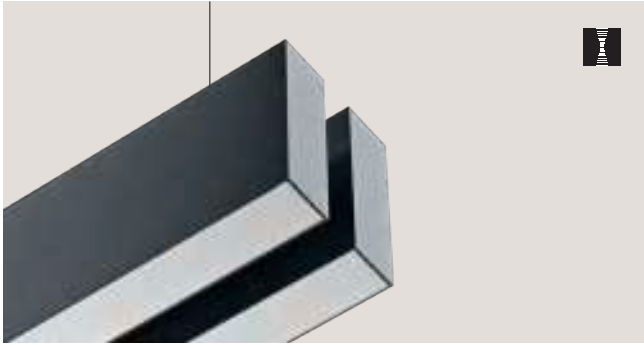

4562

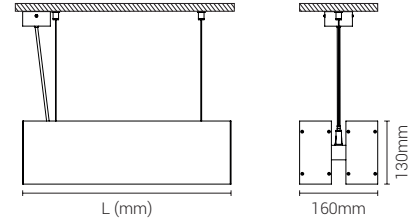

4062 | IK05 | IP40 | Módulo LED

Código	L (mm)	Fluxo/Pot. (aprox. 183lm/W)	HF (€)		
			4062	4162	4262
4062.057.xxL	570	8800 lm	266,34	396,53	389,11
4062.071.xxL	710	11000 lm	342,13	437,83	430,41
4062.085.xxL	850	13200 lm	373,67	469,36	461,94
4062.099.xxL	990	15400 lm	414,96	510,66	503,24
4062.113.xxL	1130	17600 lm	437,90	533,60	526,18
4062.127.xxL	1270	19800 lm	479,82	576,75	567,48
4062.141.xxL	1410	22000 lm	511,35	608,29	599,01
4062.155.xxL	1550	24200 lm	552,65	649,58	640,31
4062.169.xxL	1690	26400 lm	575,59	672,52	663,25
4062.183.xxL	1830	28600 lm	616,89	713,82	704,55
4062.197.xxL	1970	30800 lm	648,42	745,36	736,08
4062.211.xxL	2110	33000 lm	690,71	787,64	778,37
4062.225.xxL	2250	35200 lm	713,65	810,58	801,31
4062.239.xxL	2390	37400 lm	806,26	1.002,72	942,76
4062.253.xxL	2530	39600 lm	837,79	1.034,25	974,29
4062.267.xxL	2670	41800 lm	879,09	1.075,55	1.015,59
4062.281.xxL	2810	44000 lm	902,03	1.100,35	1.038,53
4062.295.xxL	2950	46200 lm	955,32	1.155,49	1.091,82
4062.309.xxL	3090	48400 lm	986,86	1.187,02	1.123,35
4062.323.xxL	3230	50600 lm	1.028,16	1.228,32	1.164,65
4062.337.xxL	3370	52800 lm	1.051,10	1.251,26	1.187,59
4062.351.xxL	3510	55000 lm	1.139,13	1.299,12	1.308,02
4062.365.xxL	3650	57200 lm	1.170,66	1.330,65	1.339,55
4062.379.xxL	3790	59400 lm	1.211,96	1.371,95	1.380,85
4062.393.xxL	3930	61600 lm	1.234,90	1.394,89	1.403,79
4062.407.xxL	4070	63800 lm	1.276,20	1.436,19	1.445,09
4062.421.xxL	4210	66000 lm	1.307,73	1.467,72	1.476,62
4062.435.xxL	4350	68100 lm	1.349,03	1.509,02	1.517,92
4062.449.xxL	4490	70400 lm	1.371,97	1.531,96	1.540,86
4062.463.xxL	4630	72600 lm	1.464,58	1.724,09	1.682,30
4062.477.xxL	4770	74800 lm	1.496,11	1.757,48	1.713,84
4062.491.xxL	4910	77000 lm	1.537,41	1.798,78	1.755,14
4062.505.xxL	5050	79200 lm	1.560,35	1.821,72	1.778,08

2700K | 3000K | 4000K | 5000K | 6500K

4562 | IK05 | IP40 | Módulo LED

Código	L (mm)	Fluxo/Pot. (aprox. 183lm/W)	HF (€)		
			4562	4662	4762
4562.057.xxL	570	8800 lm	280,72	410,91	410,91
4562.071.xxL	710	11000 lm	357,67	455,22	455,22
4562.085.xxL	850	13200 lm	391,97	489,52	489,52
4562.099.xxL	990	15400 lm	436,29	533,84	533,84
4562.113.xxL	1130	17600 lm	459,89	557,44	557,44
4562.127.xxL	1270	19800 lm	501,73	603,61	603,61
4562.141.xxL	1410	22000 lm	536,03	637,91	637,91
4562.155.xxL	1550	24200 lm	580,34	682,22	682,22
4562.169.xxL	1690	26400 lm	603,95	705,83	705,83
4562.183.xxL	1830	28600 lm	648,26	750,14	750,14
4562.197.xxL	1970	30800 lm	682,56	784,44	784,44
4562.211.xxL	2110	33000 lm	727,87	829,74	829,74
4562.225.xxL	2250	35200 lm	751,47	853,35	853,35
4562.239.xxL	2390	37400 lm	851,42	1.048,50	984,21
4562.253.xxL	2530	39600 lm	885,72	1.082,80	1.018,50
4562.267.xxL	2670	41800 lm	930,03	1.127,11	1.062,82
4562.281.xxL	2810	44000 lm	953,64	1.152,57	1.086,42
4562.295.xxL	2950	46200 lm	1.009,94	1.210,73	1.142,73
4562.309.xxL	3090	48400 lm	1.044,24	1.245,03	1.177,03
4562.323.xxL	3230	50600 lm	1.088,56	1.289,34	1.221,34
4562.337.xxL	3370	52800 lm	1.112,16	1.312,95	1.244,95
4562.351.xxL	3510	55000 lm	1.193,94	1.363,81	1.391,26
4562.365.xxL	3650	57200 lm	1.228,24	1.398,11	1.425,56
4562.379.xxL	3790	59400 lm	1.272,55	1.442,43	1.469,87
4562.393.xxL	3930	61600 lm	1.296,15	1.466,03	1.493,48
4562.407.xxL	4070	63800 lm	1.340,47	1.510,35	1.537,79
4562.421.xxL	4210	66000 lm	1.374,77	1.544,64	1.572,09
4562.435.xxL	4350	68100 lm	1.419,08	1.588,96	1.616,41
4562.449.xxL	4490	70400 lm	1.442,69	1.612,56	1.640,01
4562.463.xxL	4630	72600 lm	1.542,64	1.807,71	1.770,87
4562.477.xxL	4770	74800 lm	1.576,94	1.843,87	1.805,17
4562.491.xxL	4910	77000 lm	1.621,25	1.888,18	1.849,48
4562.505.xxL	5050	79200 lm	1.644,85	1.911,78	1.873,09

2700K | 3000K | 4000K | 5000K | 6500K

Acessórios

Standard/Incluído	Opção	Opção	Opção	Opção
5084.FSR.xxx Florão Saliente Redondo Ø58mm	5084.FSQ.xxx Florão Saliente Quadrado 58x58mm 9,36€	5084.FER.xxx Florão Encastrado Redondo Ø55mm 8,77€	5084.FEQ.xxx Florão Encastrado Quadrado 50x50mm 8,87€	5084.CDR.xxx Caixa para Driver 16,97€
				5084.COS.xxx Cabos de Suspensão Standard/Incluído 1,5 metros 5084.xAx.xxx Cabo de Alimentação Standard/Incluído 1,5 metros Outras Medidas na Página 243

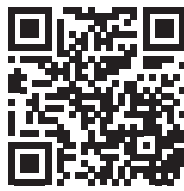

Opalino
código: 4xxx.xxx.xOL



Prismático
código: 4xxx.xxx.xPL



Alumínio
código: 4xxx.xxx.xAL



Black
código: 4xxx.xxx.xBL



KIT EMG 1H

81,29€



KIT EMG 3H

104,78€



Estas luminárias podem incluir estes componentes elétricos a partir de 1130mm.



5050

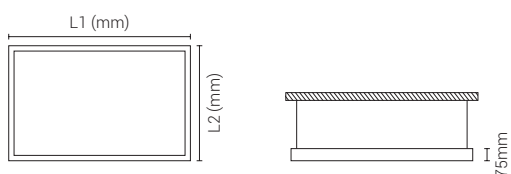

5051

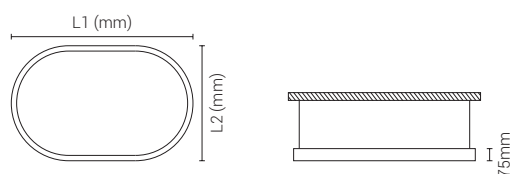
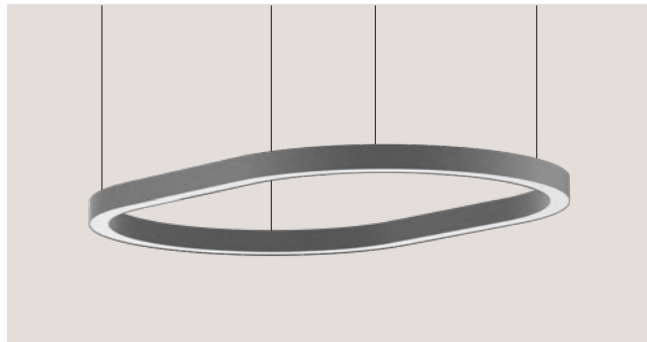

5050 IK05 IP40 Módulo LED						
Código	L1 (mm)	L2 (mm)	Fluxo/Pot. (aprox. 183lm/W)	HF (€) 5050	1-10V (€) 5150	DALI (€) 5250
5050.064.xxL	640	640	8800 lm	262,00	392,19	384,77
5050.092.xxL	920	920	13200 lm	373,67	469,36	461,94
5050.120.xxL	1200	640	13200 lm	352,12	465,06	457,65
5050.148.xxL	1480	920	17600 lm	438,17	534,48	526,14

2700K | 3000K | 4000K | 5000K | 6500K

5051 IK05 IP40 Módulo LED						
Código	L1 (mm)	L2 (mm)	Fluxo/Pot. (aprox. 183lm/W)	HF (€) 5051	1-10V (€) 5151	DALI (€) 5251
5051.145.xOL	1450	1170	15400 lm	1038,19	1144,78	1133,68
5051.173.xOL	1730	1170	17600 lm	1078,13	1271,04	1257,72
5051.228.xOL	2289	1170	22000 lm	1183,85	1356,07	1342,75
5051.213.xOL	2130	1570	22000 lm	1158,00	1350,91	1337,59
5051.269.xOL	2690	1570	26400 lm	1263,72	1435,94	1422,62

2700K | 3000K | 4000K | 5000K | 6500K

Acessórios			
Standard/Incluído	Opção	Opção	Opção
5084.FSR.xXX Florão Saliente Redondo Ø58mm	5084.FSQ.xXX Florão Saliente Quadrado 58x58mm 9,36€	5084.FER.xXX Florão Encastrado Redondo Ø55mm 8,77€	5084.FEQ.xXX Florão Encastrado Quadrado 50x50mm 8,87€
5084.CDR.xXX Caixa para Driver 16,97€	5084.COS.xXX Cabos de Suspensão Standard/Incluído 1,5 metros 5084.xAx.xXX Cabo de Alimentação Standard/Incluído 1,5 metros Outras Medidas na Página 243		

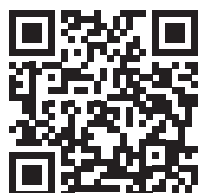

1

Branco

código:
5x5x.xxx.10L

2

Cinza

código:
5x5x.xxx.20L

3

Cinza Satinado

código:
5x5x.xxx.30L

4

Escovado

código:
5x5x.xxx.40L

7

Grafite

código:
5x5x.xxx.70L

9

Preto

código:
5x5x.xxx.90L

0

RAL sob Consulta

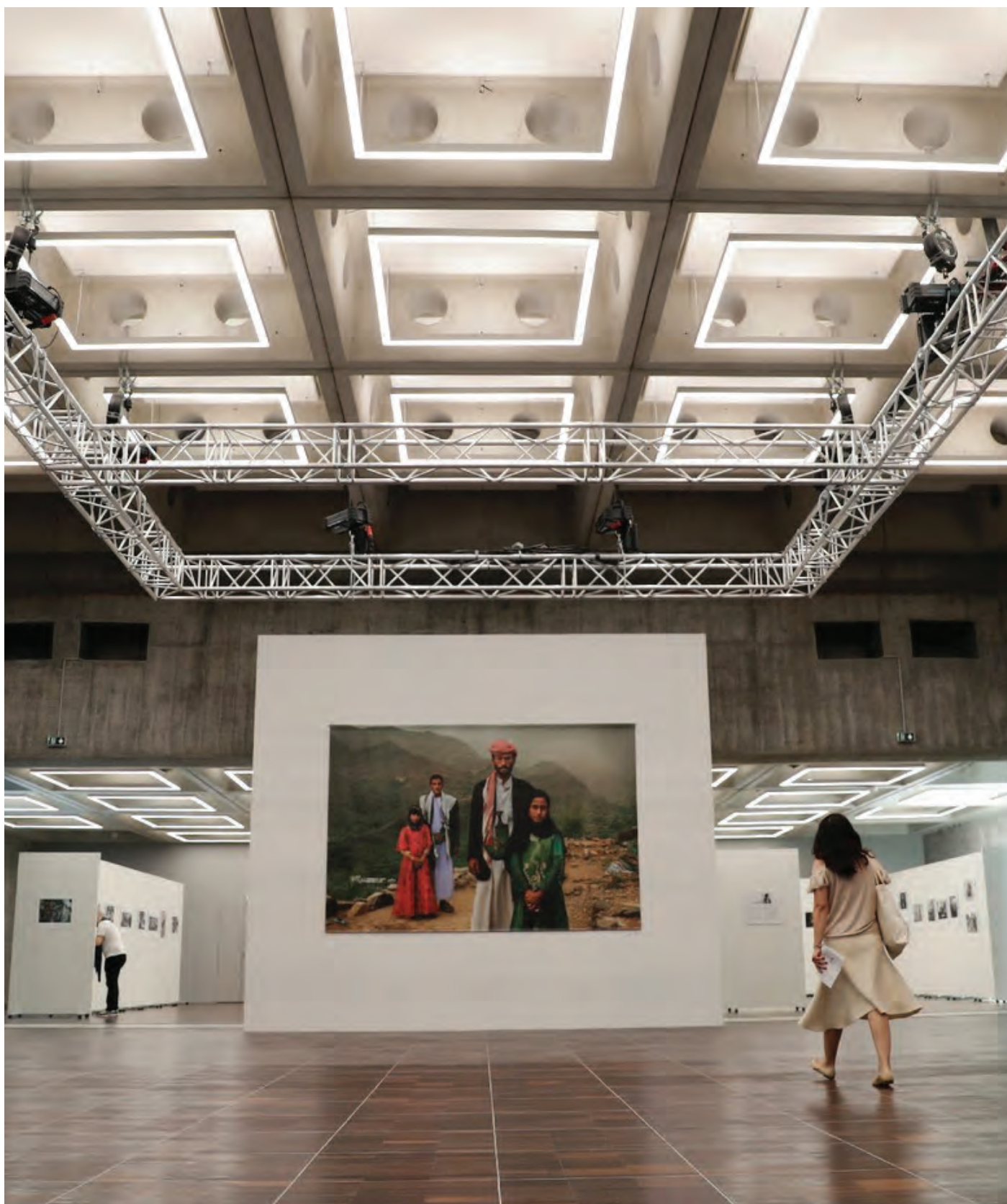

Opalino

código:
5x5x.xxx.xOL



Prismático

código:
5x50.xxx.xPL



Black

código:
5x50.xxx.xBL



KIT EMG
1H

KIT EMG
3H

81,29€

104,78€

Estas luminárias podem incluir
estes componentes elétricos a
partir de 1130mm.





4520 | 4521



Informação Importante: Driver Remoto Incluído
(não integrado na luminária)

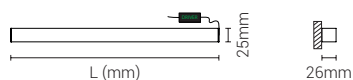

4520 IK04 IP40 Módulo LED					
Código	L (mm)	Fluxo/Pot. (aprox. 184lm/W)	HF (€)	1-10V (€)	DALI (€)
			4520	4620	4720
4520.015.xxL	150	490 lm	28,09	-	-
4520.029.xxL	290	980 lm	32,65	-	-
4520.043.xxL	430	1470 lm	39,34	-	-
4520.057.xxL	570	1960 lm	42,71	73,15	73,40
4520.071.xxL	710	2450 lm	58,02	79,84	80,09
4520.085.xxL	850	2940 lm	62,58	84,40	84,65
4520.099.xxL	990	3430 lm	69,27	91,10	91,34
4520.113.xxL	1130	3920 lm	72,64	94,46	94,71
4520.127.xxL	1270	4410 lm	79,33	101,16	101,40
4520.141.xxL	1410	4900 lm	83,89	108,28	105,96
4520.155.xxL	1550	5390 lm	90,71	115,10	112,78
4520.169.xxL	1690	5880 lm	94,08	118,47	116,15
4520.183.xxL	1830	6370 lm	100,92	125,16	122,84
4520.197.xxL	1970	6860 lm	105,48	129,72	127,40
4520.211.xxL	2110	7350 lm	112,18	136,41	134,09
4520.225.xxL	2250	7840 lm	115,54	139,78	137,46
4520.239.xxL	2390	8330 lm	122,24	146,47	144,15
4520.253.xxL	2530	8820 lm	126,80	151,03	148,71
4520.267.xxL	2670	9310 lm	133,49	157,79	155,40
4520.281.xxL	2810	9800 lm	136,86	159,16	158,77
4520.295.xxL	2950	10290 lm	143,55	165,85	165,45
4520.309.xxL	3090	10780 lm	148,11	171,98	170,02
4520.323.xxL	3230	11270 lm	154,92	177,92	176,84
4520.337.xxL	3370	11760 lm	171,12	221,16	205,24
4520.351.xxL	3510	12250 lm	177,81	227,85	211,93

2700K | 3000K | 4000K | 5000K | 6500K

4521 IK04 IP40 Fita LED				
Código	L (mm)	Fluxo/Pot. (aprox. 138lm/W)	HF (€)	DALI (€)
			4521	4721
4521.051.xxL	510	750 lm	41,63	92,41
4521.061.xxL	610	900 lm	46,09	96,88
4521.071.xxL	710	1050 lm	50,56	101,34
4521.081.xxL	810	1200 lm	55,02	105,81
4521.091.xxL	910	1350 lm	59,49	110,27
4521.101.xxL	1010	1500 lm	63,96	114,74
4521.111.xxL	1110	1650 lm	68,42	119,21
4521.121.xxL	1210	1800 lm	72,89	123,67
4521.131.xxL	1310	1950 lm	77,36	128,14
4521.141.xxL	1410	2100 lm	81,82	132,61
4521.151.xxL	1510	2250 lm	86,29	137,07
4521.161.xxL	1610	2400 lm	90,76	141,54
4521.171.xxL	1710	2550 lm	95,22	146,01
4521.181.xxL	1810	2700 lm	99,69	150,47
4521.191.xxL	1910	2850 lm	104,15	154,94
4521.201.xxL	2010	3000 lm	108,62	159,40
4521.211.xxL	2110	3150 lm	113,09	163,87
4521.221.xxL	2210	3300 lm	117,55	168,34
4521.231.xxL	2310	3450 lm	122,02	172,80
4521.241.xxL	2410	3600 lm	126,49	177,27
4521.251.xxL	2510	3750 lm	130,95	181,74
4521.261.xxL	2610	3900 lm	135,42	186,20
4521.271.xxL	2710	4050 lm	139,89	190,67
4521.281.xxL	2810	4200 lm	165,22	210,78
4521.291.xxL	2910	4350 lm	169,68	215,24
4521.301.xxL	3010	4500 lm	174,15	219,71

2700K | 3000K | 4000K | 6500K | RGB sob consulta

1-10V sob consulta

4521 IK04 IP65 Driver IP20 Fita LED				
Código	L (mm)	Fluxo/Pot. (aprox. 83,2lm/W)	HF (€)	DALI (€)
			4521	4721
4521.052.xxL	520	610 lm	43,17	93,95
4521.062.xxL	620	732 lm	47,95	98,73
4521.072.xxL	720	854 lm	52,72	103,51
4521.082.xxL	820	976 lm	57,50	108,28
4521.092.xxL	920	1098 lm	62,27	113,06
4521.102.xxL	1020	1220 lm	67,05	117,83
4521.112.xxL	1120	1342 lm	71,82	122,61
4521.122.xxL	1220	1464 lm	76,60	127,38
4521.132.xxL	1320	1586 lm	81,37	132,16
4521.142.xxL	1420	1708 lm	86,15	136,93
4521.152.xxL	1520	1830 lm	90,93	141,71
4521.162.xxL	1620	1952 lm	95,70	146,48
4521.172.xxL	1720	2074 lm	100,48	151,26
4521.182.xxL	1820	2196 lm	105,25	156,04
4521.192.xxL	1920	2318 lm	110,03	160,81
4521.202.xxL	2020	2440 lm	114,80	165,59
4521.212.xxL	2120	2562 lm	119,58	170,36
4521.222.xxL	2220	2684 lm	124,35	175,14
4521.232.xxL	2320	2806 lm	129,13	179,91
4521.242.xxL	2420	2928 lm	133,90	184,69
4521.252.xxL	2520	3050 lm	138,68	189,46
4521.262.xxL	2620	3172 lm	143,46	194,24
4521.272.xxL	2720	3294 lm	148,23	199,01
4521.282.xxL	2820	3416 lm	173,87	219,43
4521.292.xxL	2920	3538 lm	178,65	224,21
4521.302.xxL	3020	3660 lm	183,42	228,98

2700K | 3000K | 4000K | 6000K | RGB sob consulta

1-10V sob consulta



1

Branco

código:
4x2x.xxx.10L

2

Cinza

código:
4x2x.xxx.20L

3

Cinza Satinado

código:
4x2x.xxx.30L

4

Escovado

código:
4x2x.xxx.40L

7

Grafite

código:
4x2x.xxx.70L

9

Preto

código:
4x2x.xxx.90L

0

RAL sob Consulta

Podem ser instalados em linhas contínuas, com a forma e comprimento solicitados.



Opalino

código:
4x2x.xxx.xOL



Black

código:
4x2x.xxx.xBL





4536

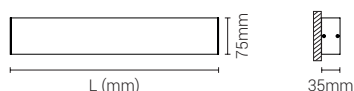

4021

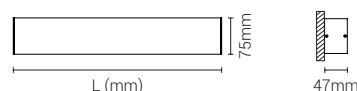

4536 IK04 IP40 Módulo LED					
Código	L (mm)	Fluxo/Pot. (aprox. 183lm/W)	HF (€) 4536	1-10V (€) 4636	DALI (€) 4736
4536.029.xxL	290	1100 lm	41,44	-	-
4536.043.xxL	430	1650 lm	50,91	-	-
4536.057.xxL	570	2200 lm	55,79	88,34	86,48
4536.071.xxL	710	2750 lm	73,89	97,81	95,96
4536.085.xxL	850	3300 lm	80,92	104,84	102,99
4536.099.xxL	990	3850 lm	90,39	114,31	112,46
4536.113.xxL	1130	4400 lm	95,27	119,20	117,34
4536.127.xxL	1270	4950 lm	104,90	129,13	126,81
4536.141.xxL	1410	5500 lm	111,93	136,16	133,84
4536.155.xxL	1550	6050 lm	121,40	145,63	143,32
4536.169.xxL	1690	6600 lm	126,28	150,52	148,20
4536.183.xxL	1830	7150 lm	135,76	159,99	157,67
4536.197.xxL	1970	7700 lm	142,79	167,02	164,70
4536.211.xxL	2110	8250 lm	152,51	176,74	174,42
4536.225.xxL	2250	8800 lm	157,39	181,62	179,30
4536.239.xxL	2390	9350 lm	179,69	228,80	213,81
4536.253.xxL	2530	9900 lm	186,72	235,83	220,84
4536.267.xxL	2670	10450 lm	196,19	245,31	230,32
4536.281.xxL	2810	11000 lm	201,07	250,65	235,20
4536.295.xxL	2950	11550 lm	210,55	260,59	244,67
4536.309.xxL	3090	12100 lm	217,58	267,62	251,70
4536.323.xxL	3230	12650 lm	227,05	277,09	261,17
4536.337.xxL	3370	13200 lm	231,93	281,97	266,06
4536.351.xxL	3510	13750 lm	253,09	293,08	295,31
4536.365.xxL	3650	14300 lm	260,12	300,12	302,34
4536.379.xxL	3790	14850 lm	269,59	309,59	311,81
4536.393.xxL	3930	15400 lm	274,47	314,47	316,70
4536.407.xxL	4070	15950 lm	283,95	323,94	326,17
4536.421.xxL	4210	16500 lm	290,98	330,97	333,20
4536.435.xxL	4350	17050 lm	300,45	340,45	342,67
4536.449.xxL	4490	17600 lm	305,33	345,33	347,55
4536.463.xxL	4630	18150 lm	327,63	392,51	382,06
4536.477.xxL	4770	18700 lm	334,66	400,00	389,09
4536.491.xxL	4910	19250 lm	344,13	409,48	398,57
4536.505.xxL	5050	19800 lm	349,02	414,36	403,45

2700K | 3000K | 4000K | 5000K | 6500K

4021 IK05 IP40 Módulo LED					
Código	L (mm)	Fluxo/Pot. (aprox. 183lm/W)	HF (€) 4021	1-10V (€) 4121	DALI (€) 4221
4021.029.xxL	290	1100 lm	43,57	-	-
4021.043.xxL	430	1650 lm	53,89	-	-
4021.057.xxL	570	2200 lm	59,63	92,17	90,32
4021.071.xxL	710	2750 lm	78,58	102,50	100,64
4021.085.xxL	850	3300 lm	86,46	110,38	108,53
4021.099.xxL	990	3850 lm	96,78	120,71	118,85
4021.113.xxL	1130	4400 lm	102,52	126,44	124,59
4021.127.xxL	1270	4950 lm	113,00	137,23	134,91
4021.141.xxL	1410	5500 lm	120,88	145,11	142,80
4021.155.xxL	1550	6050 lm	131,21	155,44	153,12
4021.169.xxL	1690	6600 lm	136,94	161,17	158,86
4021.183.xxL	1830	7150 lm	147,27	171,50	169,18
4021.197.xxL	1970	7700 lm	155,15	179,38	177,06
4021.211.xxL	2110	8250 lm	165,72	189,95	187,64
4021.225.xxL	2250	8800 lm	171,46	195,69	193,37
4021.239.xxL	2390	9350 lm	194,61	243,72	228,73
4021.253.xxL	2530	9900 lm	202,49	251,61	236,61
4021.267.xxL	2670	10450 lm	212,82	261,93	246,94
4021.281.xxL	2810	11000 lm	218,55	268,13	252,67
4021.295.xxL	2950	11550 lm	228,88	278,92	263,00
4021.309.xxL	3090	12100 lm	236,76	286,80	270,88
4021.323.xxL	3230	12650 lm	247,08	297,13	281,21
4021.337.xxL	3370	13200 lm	252,82	302,86	286,94
4021.351.xxL	3510	13750 lm	274,83	314,82	317,05
4021.365.xxL	3650	14300 lm	282,71	322,71	324,93
4021.379.xxL	3790	14850 lm	293,03	333,03	335,26
4021.393.xxL	3930	15400 lm	298,77	338,77	340,99
4021.407.xxL	4070	15950 lm	309,09	349,09	351,32
4021.421.xxL	4210	16500 lm	316,98	356,97	359,20
4021.435.xxL	4350	17050 lm	327,30	367,30	369,52
4021.449.xxL	4490	17600 lm	333,04	373,03	375,26
4021.463.xxL	4630	18150 lm	356,19	421,07	410,62
4021.477.xxL	4770	18700 lm	364,07	429,41	418,50
4021.491.xxL	4910	19250 lm	374,40	439,74	428,83
4021.505.xxL	5050	19800 lm	380,13	445,47	434,56

2700K | 3000K | 4000K | 5000K | 6500K



- | | | | | | | |
|----------------------|----------------------|----------------------|----------------------|----------------------|----------------------|------------------|
| 1 | 2 | 3 | 4 | 7 | 9 | 0 |
| Branco | Cinza | Cinza Satinado | Escovado | Grafite | Preto | RAL sob Consulta |
| código: 4xxx.xxx.1xL | código: 4xxx.xxx.2xL | código: 4xxx.xxx.3xL | código: 4xxx.xxx.4xL | código: 4xxx.xxx.7xL | código: 4xxx.xxx.9xL | |

Podem ser instalados em linhas contínuas, com a forma e comprimento solicitados.



4022

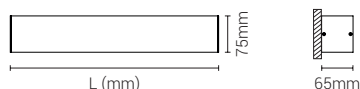

4023

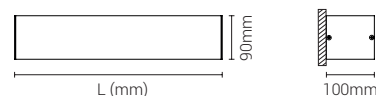

4022 IK05 IP40 Módulo LED					
Código	L (mm)	Fluxo/Pot. (aprox. 183lm/W)	HF (€) 4022	1-10V (€) 4122	DALI (€) 4222
4022.029.xxL	290	1100 lm	44,29	-	-
4022.043.xxL	430	1650 lm	54,91	-	-
4022.057.xxL	570	2200 lm	60,93	93,48	91,62
4022.071.xxL	710	2750 lm	80,17	104,09	102,24
4022.085.xxL	850	3300 lm	88,34	112,27	110,41
4022.099.xxL	990	3850 lm	98,96	122,88	121,03
4022.113.xxL	1130	4400 lm	104,98	128,91	127,05
4022.127.xxL	1270	4950 lm	115,75	139,98	137,67
4022.141.xxL	1410	5500 lm	123,93	148,16	145,84
4022.155.xxL	1550	6050 lm	134,54	158,77	156,45
4022.169.xxL	1690	6600 lm	140,56	164,80	162,48
4022.183.xxL	1830	7150 lm	151,18	175,41	173,09
4022.197.xxL	1970	7700 lm	159,35	183,59	181,27
4022.211.xxL	2110	8250 lm	170,21	194,45	192,13
4022.225.xxL	2250	8800 lm	176,24	200,47	198,15
4022.239.xxL	2390	9350 lm	199,68	248,80	233,81
4022.253.xxL	2530	9900 lm	207,85	256,97	241,98
4022.267.xxL	2670	10450 lm	218,47	267,58	252,59
4022.281.xxL	2810	11000 lm	224,49	274,07	258,62
4022.295.xxL	2950	11550 lm	235,11	285,15	269,23
4022.309.xxL	3090	12100 lm	243,28	293,32	277,41
4022.323.xxL	3230	12650 lm	253,90	303,94	288,02
4022.337.xxL	3370	13200 lm	259,92	309,96	294,04
4022.351.xxL	3510	13750 lm	282,22	322,22	324,44
4022.365.xxL	3650	14300 lm	290,39	330,39	332,61
4022.379.xxL	3790	14850 lm	301,01	341,00	343,23
4022.393.xxL	3930	15400 lm	307,03	347,03	349,25
4022.407.xxL	4070	15950 lm	317,65	357,64	359,87
4022.421.xxL	4210	16500 lm	325,82	365,82	368,04
4022.435.xxL	4350	17050 lm	336,43	376,43	378,66
4022.449.xxL	4490	17600 lm	342,46	382,46	384,68
4022.463.xxL	4630	18150 lm	365,90	430,78	420,33
4022.477.xxL	4770	18700 lm	374,07	439,42	428,51
4022.491.xxL	4910	19250 lm	384,69	450,03	439,12
4022.505.xxL	5050	19800 lm	390,71	456,06	445,15

2700K | 3000K | 4000K | 5000K | 6500K

4023 IK05 IP40 Módulo LED					
Código	L (mm)	Fluxo/Pot. (aprox. 183lm/W)	HF (€) 4023	1-10V (€) 4123	DALI (€) 4223
4023.029.xxL	290	1100 lm	51,94	-	-
4023.043.xxL	430	1650 lm	64,25	-	-
4023.057.xxL	570	2200 lm	71,98	104,53	102,67
4023.071.xxL	710	2750 lm	92,92	116,84	114,99
4023.085.xxL	850	3300 lm	102,79	126,72	124,86
4023.099.xxL	990	3850 lm	115,11	139,03	137,18
4023.113.xxL	1130	4400 lm	122,83	146,76	144,90
4023.127.xxL	1270	4950 lm	135,30	159,54	157,22
4023.141.xxL	1410	5500 lm	145,18	169,41	167,09
4023.155.xxL	1550	6050 lm	157,49	181,73	179,41
4023.169.xxL	1690	6600 lm	165,22	189,45	187,13
4023.183.xxL	1830	7150 lm	177,53	201,77	199,45
4023.197.xxL	1970	7700 lm	187,41	211,64	209,32
4023.211.xxL	2110	8250 lm	201,02	225,25	222,93
4023.225.xxL	2250	8800 lm	208,75	232,98	230,66
4023.239.xxL	2390	9350 lm	233,89	283,00	268,01
4023.253.xxL	2530	9900 lm	243,76	292,88	277,89
4023.267.xxL	2670	10450 lm	256,08	305,19	290,20
4023.281.xxL	2810	11000 lm	263,80	313,38	297,93
4023.295.xxL	2950	11550 lm	276,12	326,16	310,24
4023.309.xxL	3090	12100 lm	285,99	336,03	320,12
4023.323.xxL	3230	12650 lm	298,31	348,35	332,43
4023.337.xxL	3370	13200 lm	306,03	356,07	340,16
4023.351.xxL	3510	13750 lm	331,08	371,08	373,30
4023.365.xxL	3650	14300 lm	340,96	380,95	383,18
4023.379.xxL	3790	14850 lm	353,27	393,27	395,49
4023.393.xxL	3930	15400 lm	361,00	400,99	403,22
4023.407.xxL	4070	15950 lm	373,31	413,31	415,53
4023.421.xxL	4210	16500 lm	383,19	423,18	425,41
4023.435.xxL	4350	17050 lm	395,50	435,50	437,72
4023.449.xxL	4490	17600 lm	403,23	443,22	445,45
4023.463.xxL	4630	18150 lm	428,37	493,25	482,80
4023.477.xxL	4770	18700 lm	438,24	503,59	492,67
4023.491.xxL	4910	19250 lm	450,56	515,90	504,99
4023.505.xxL	5050	19800 lm	458,28	523,63	512,72

2700K | 3000K | 4000K | 5000K | 6500K

A versão "Black" não se aplica à referência 4023.



Opalino

código: 4xxx.xxx.x0L



Prismático

código: 4xxx.xxx.xPL



Black

código: 4xxx.xxx.xBL



KIT EMG 1 H



KIT EMG 3 H

81,29€

104,78€



Estas luminárias podem incluir estes componentes elétricos a partir de 1130mm.



4546



4024

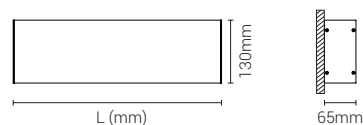

4546 IK04 IP40 Módulo LED					
Código	L (mm)	Fluxo/Pot. (aprox. 183lm/W)	HF (€) 4546	1-10V (€) 4646	DALI (€) 4746
4546.029.xxL	290	2200 lm	74,78	-	-
4546.043.xxL	430	3300 lm	91,27	-	-
4546.057.xxL	570	4400 lm	98,97	164,06	157,88
4546.071.xxL	710	5000 lm	131,78	180,56	174,37
4546.085.xxL	850	6600 lm	141,32	190,09	183,91
4546.099.xxL	990	7700 lm	157,81	206,58	200,40
4546.113.xxL	1130	8800 lm	165,51	214,28	208,10
4546.127.xxL	1270	9900 lm	180,76	231,70	225,52
4546.141.xxL	1410	11000 lm	190,30	241,24	235,06
4546.155.xxL	1550	12100 lm	206,79	257,73	251,55
4546.169.xxL	1690	13200 lm	216,81	267,75	261,57
4546.183.xxL	1830	14300 lm	233,30	284,24	278,06
4546.197.xxL	1970	15400 lm	242,84	293,78	287,60
4546.211.xxL	2110	16500 lm	259,83	310,76	304,58
4546.225.xxL	2250	17600 lm	267,52	318,46	312,28
4546.239.xxL	2390	18700 lm	311,83	410,37	372,04
4546.253.xxL	2530	19800 lm	323,69	422,23	383,90
4546.267.xxL	2670	20900 lm	340,18	438,72	400,39
4546.281.xxL	2810	22000 lm	347,88	447,34	408,09
4546.295.xxL	2950	23100 lm	364,37	464,76	424,58
4546.309.xxL	3090	24200 lm	373,91	474,30	434,12
4546.323.xxL	3230	25300 lm	390,40	490,79	450,61
4546.337.xxL	3370	26400 lm	398,10	498,49	458,31
4546.351.xxL	3510	27500 lm	433,32	518,26	525,80
4546.365.xxL	3650	28600 lm	442,86	527,80	535,34
4546.379.xxL	3790	29700 lm	459,35	544,29	551,83
4546.393.xxL	3930	30800 lm	469,37	554,30	561,85
4546.407.xxL	4070	31900 lm	485,86	570,80	578,34
4546.421.xxL	4210	33000 lm	495,40	580,33	587,88
4546.435.xxL	4350	34100 lm	511,89	596,83	604,37
4546.449.xxL	4490	35200 lm	519,59	604,52	612,07
4546.463.xxL	4630	36300 lm	563,90	696,43	671,83
4546.477.xxL	4770	37400 lm	573,43	706,90	681,37
4546.491.xxL	4910	38500 lm	589,93	723,39	697,86
4546.505.xxL	5050	39600 lm	597,62	731,09	705,56

2700K | 3000K | 4000K | 5000K | 6500K

4024 IK06 IP40 Módulo LED					
Código	L (mm)	Fluxo/Pot. (aprox. 183lm/W)	HF (€) 4024	1-10V (€) 4124	DALI (€) 4224
4024.029.xxL	290	2200 lm	99,59	-	-
4024.043.xxL	430	3300 lm	121,74	-	-
4024.057.xxL	570	4400 lm	133,55	198,64	198,64
4024.071.xxL	710	5500 lm	172,02	220,80	220,80
4024.085.xxL	850	6600 lm	189,17	237,95	237,95
4024.099.xxL	990	7700 lm	211,33	260,10	260,10
4024.113.xxL	1130	8800 lm	223,13	271,91	271,91
4024.127.xxL	1270	9900 lm	244,05	294,99	294,99
4024.141.xxL	1410	11000 lm	261,20	312,14	312,14
4024.155.xxL	1550	12100 lm	283,36	334,30	334,30
4024.169.xxL	1690	13200 lm	299,80	350,74	350,74
4024.183.xxL	1830	14300 lm	321,96	372,89	372,89
4024.197.xxL	1970	15400 lm	339,10	390,04	390,04
4024.211.xxL	2110	16500 lm	361,76	412,69	412,69
4024.225.xxL	2250	17600 lm	373,56	424,50	424,50
4024.239.xxL	2390	18700 lm	423,53	522,07	489,93
4024.253.xxL	2530	19800 lm	445,32	543,86	511,71
4024.267.xxL	2670	20900 lm	467,48	566,01	533,87
4024.281.xxL	2810	22000 lm	479,28	578,74	545,67
4024.295.xxL	2950	23100 lm	501,44	601,83	567,83
4024.309.xxL	3090	24200 lm	518,59	618,98	584,98
4024.323.xxL	3230	25300 lm	540,74	641,13	607,13
4024.337.xxL	3370	26400 lm	552,54	652,94	618,94
4024.351.xxL	3510	27500 lm	593,43	678,37	692,09
4024.365.xxL	3650	28600 lm	610,58	695,52	709,24
4024.379.xxL	3790	29700 lm	632,74	717,68	731,40
4024.393.xxL	3930	30800 lm	649,18	734,12	747,84
4024.407.xxL	4070	31900 lm	671,33	756,27	770,00
4024.421.xxL	4210	33000 lm	688,48	773,42	787,15
4024.435.xxL	4350	34100 lm	710,64	795,58	809,30
4024.449.xxL	4490	35200 lm	722,44	807,38	821,10
4024.463.xxL	4630	36300 lm	772,42	904,96	886,53
4024.477.xxL	4770	37400 lm	789,57	923,03	903,68
4024.491.xxL	4910	38500 lm	811,72	945,19	925,84
4024.505.xxL	5050	39600 lm	823,53	956,99	937,64

2700K | 3000K | 4000K | 5000K | 6500K



1

Branco

código:
4xxx.xxx.1xL

2

Cinza

código:
4xxx.xxx.2xL

3

Cinza Sati-
nado

código:
4xxx.xxx.3xL

4

Escovado

código:
4xxx.xxx.4xL

7

Grafite

código:
4xxx.xxx.7xL

9

Preto

código:
4xxx.xxx.9xL

0

RAL sob Consulta

Podem ser instalados em linhas contínuas, com a forma e comprimento solicitados.



4020

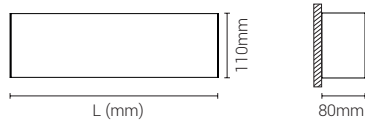
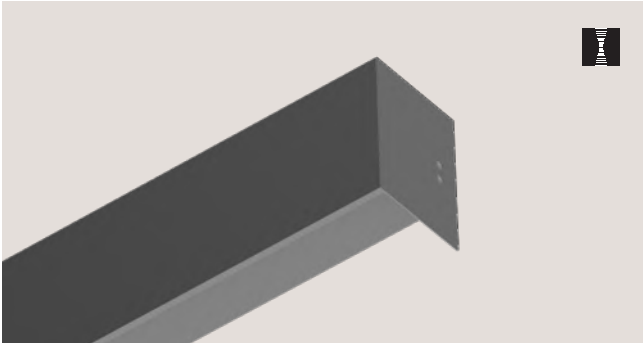

4020 | IK06 | IP40 | Módulo LED

Código	L (mm)	Fluxo/Pot. (aprox. 183lm/W)	Preço		
			HF (€) 4020	1-10V (€) 4120	DALI (€) 4220
4020.029.xOL	290	1100 lm	55,61	-	-
4020.043.xOL	430	1650 lm	66,85	-	-
4020.057.xOL	570	2200 lm	73,50	99,12	101,22
4020.071.xOL	710	2750 lm	93,36	110,36	112,46
4020.085.xOL	850	3300 lm	102,16	119,16	121,26
4020.099.xOL	990	3850 lm	113,40	130,40	132,50
4020.113.xOL	1130	4400 lm	120,05	137,05	139,15
4020.127.xOL	1270	4950 lm	131,45	148,29	150,86
4020.141.xOL	1410	5500 lm	140,25	157,09	159,66
4020.155.xOL	1550	6050 lm	151,49	168,33	170,90
4020.169.xOL	1690	6600 lm	158,14	174,98	177,55
4020.183.xOL	1830	7150 lm	169,38	186,22	188,79
4020.197.xOL	1970	7700 lm	178,18	195,02	197,59
4020.211.xOL	2110	8250 lm	189,42	206,26	208,83
4020.225.xOL	2250	8800 lm	196,07	212,91	215,48
4020.239.xOL	2390	9350 lm	220,13	260,22	248,35
4020.253.xOL	2530	9900 lm	228,93	269,02	257,15
4020.267.xOL	2670	10450 lm	240,17	280,26	268,39
4020.281.xOL	2810	11000 lm	246,82	286,91	275,04
4020.295.xOL	2950	11550 lm	258,06	298,15	286,28

2700K | 3000K | 4000K | 5000K | 6500K

1 2 3 7 9

Opalino
código:
4xxx.xxx.xOLPrismático
código:
4xxx.xxx.xPLBlack
código:
4xxx.xxx.xBL

81,29€



104,78€

Estas luminárias podem incluir estes componentes elétricos a partir de 1130mm.





4501



Informação Importante: Driver Remoto Incluído
(não integrado na luminária)

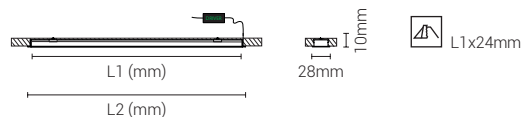

4501 IK03 IP40 Fita LED					
Código	L1 (mm)	L2 (mm)	Fluxo/Pot. (aprox. 138lm/W)	HF (€) 4501	DALI (€) 4701
4501.051.xxL	510	515	750 lm	32,02	75,23
4501.061.xxL	610	615	900 lm	34,97	78,18
4501.071.xxL	710	715	1050 lm	37,92	81,13
4501.081.xxL	810	815	1200 lm	40,87	84,08
4501.091.xxL	910	915	1350 lm	43,82	87,03
4501.101.xxL	1010	1015	1500 lm	46,77	89,98
4501.111.xxL	1110	1115	1650 lm	49,72	92,94
4501.121.xxL	1210	1215	1800 lm	52,68	95,89
4501.131.xxL	1310	1315	1950 lm	55,63	98,84
4501.141.xxL	1410	1415	2100 lm	58,58	101,79
4501.151.xxL	1510	1515	2250 lm	61,53	104,74
4501.161.xxL	1610	1615	2400 lm	64,48	107,69
4501.171.xxL	1710	1715	2550 lm	67,43	110,64
4501.181.xxL	1810	1815	2700 lm	70,38	113,59
4501.191.xxL	1910	1915	2850 lm	73,33	116,54
4501.201.xxL	2010	2015	3000 lm	76,28	119,49
4501.211.xxL	2110	2115	3150 lm	79,23	122,44
4501.221.xxL	2210	2215	3300 lm	82,18	125,40
4501.231.xxL	2310	2315	3450 lm	85,14	128,35
4501.241.xxL	2410	2415	3600 lm	88,09	131,30
4501.251.xxL	2510	2515	3750 lm	91,04	134,25
4501.261.xxL	2610	2615	3900 lm	93,99	137,20
4501.271.xxL	2710	2715	4050 lm	96,94	140,15
4501.281.xxL	2810	2815	4200 lm	99,89	143,10
4501.291.xxL	2910	2915	4350 lm	102,84	146,05

2700K | 3000K | 4000K | 6500K | RGB sob consulta

1-10V sob consulta

4501 IK03 IP65 Driver IP20 Fita LED					
Código	L1 (mm)	L2 (mm)	Fluxo/Pot. (aprox. 83,2lm/W)	HF (€) 4501	DALI (€) 4701
4501.052.xxL	520	525	610 lm	33,12	76,33
4501.062.xxL	620	625	732 lm	36,22	79,43
4501.072.xxL	720	725	854 lm	39,33	82,54
4501.082.xxL	820	825	976 lm	42,43	85,64
4501.092.xxL	920	925	1098 lm	45,54	88,75
4501.102.xxL	1020	1025	1220 lm	48,64	91,86
4501.112.xxL	1120	1125	1342 lm	51,75	94,96
4501.122.xxL	1220	1225	1464 lm	54,86	98,07
4501.132.xxL	1320	1325	1586 lm	57,96	101,17
4501.142.xxL	1420	1425	1708 lm	61,07	104,28
4501.152.xxL	1520	1525	1830 lm	64,17	107,38
4501.162.xxL	1620	1625	1952 lm	67,28	110,49
4501.172.xxL	1720	1725	2074 lm	70,38	113,59
4501.182.xxL	1820	1825	2196 lm	73,49	116,70
4501.192.xxL	1920	1925	2318 lm	76,59	119,80
4501.202.xxL	2020	2025	2440 lm	79,70	122,91
4501.212.xxL	2120	2125	2562 lm	82,80	126,02
4501.222.xxL	2220	2225	2684 lm	85,91	129,12
4501.232.xxL	2320	2325	2806 lm	89,02	132,23
4501.242.xxL	2420	2425	2928 lm	92,12	135,33
4501.252.xxL	2520	2525	3050 lm	95,23	138,44
4501.262.xxL	2620	2625	3172 lm	98,33	141,54
4501.272.xxL	2720	2725	3294 lm	101,44	144,65
4501.282.xxL	2820	2825	3416 lm	104,54	147,75
4501.292.xxL	2920	2925	3538 lm	107,65	150,86

2700K | 3000K | 4000K | 6000K | RGB sob consulta

1-10V sob consulta

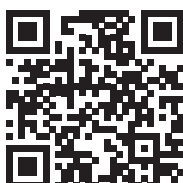

1

Branco

código:
4x01.xxx.10L

2

Cinza

código:
4x01.xxx.20L

3

Cinza Satinado

código:
4x01.xxx.30L

7

Grafite

código:
4x01.xxx.70L

9

Preto

código:
4x01.xxx.90L

0

RAL sob Consulta

Podem ser instalados em linhas contínuas, com a forma e comprimento solicitados.



Opalino
código:
4x01.xxx.x0L





4512



Informação Importante: Driver Remoto Incluído
(não integrado na luminária)

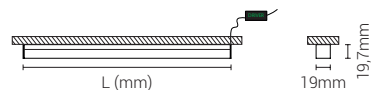

4512 IK03 IP40 Fita LED				
Código	L (mm)	Fluxo/Pot. (aprox. 138lm/W)	HF (€) 4512	DALI (€) 4712
4512.051.xOL	510	750 lm	34,47	77,68
4512.061.xOL	610	900 lm	37,90	81,11
4512.071.xOL	710	1050 lm	41,33	84,54
4512.081.xOL	810	1200 lm	44,76	87,97
4512.091.xOL	910	1350 lm	48,19	91,40
4512.101.xOL	1010	1500 lm	51,62	94,83
4512.111.xOL	1110	1650 lm	55,05	98,26
4512.121.xOL	1210	1800 lm	58,48	101,69
4512.131.xOL	1310	1950 lm	61,91	105,12
4512.141.xOL	1410	2100 lm	65,34	108,56
4512.151.xOL	1510	2250 lm	68,78	111,99
4512.161.xOL	1610	2400 lm	72,21	115,42
4512.171.xOL	1710	2550 lm	75,64	118,85
4512.181.xOL	1810	2700 lm	79,07	122,28
4512.191.xOL	1910	2850 lm	82,50	125,71
4512.201.xOL	2010	3000 lm	85,93	129,14
4512.211.xOL	2110	3150 lm	89,36	132,57
4512.221.xOL	2210	3300 lm	92,79	136,00
4512.231.xOL	2310	3450 lm	96,22	139,43
4512.241.xOL	2410	3600 lm	99,65	142,86
4512.251.xOL	2510	3750 lm	103,08	146,30
4512.261.xOL	2610	3900 lm	106,52	149,73
4512.271.xOL	2710	4050 lm	109,95	153,16
4512.281.xOL	2810	4200 lm	113,38	156,59
4512.291.xOL	2910	4350 lm	116,81	160,02

2700K | 3000K | 4000K | 6500K | RGB sob consulta

1-10V sob consulta

4512 IK03 IP65 Driver IP20 Fita LED				
Código	L (mm)	Fluxo/Pot. (aprox. 83,2lm/W)	HF (€) 4512	DALI (€) 4712
4512.052.xOL	520	610 lm	35,61	78,82
4512.062.xOL	620	732 lm	39,20	82,41
4512.072.xOL	720	854 lm	42,78	86,00
4512.082.xOL	820	976 lm	46,37	89,58
4512.092.xOL	920	1098 lm	49,96	93,17
4512.102.xOL	1020	1220 lm	53,54	96,75
4512.112.xOL	1120	1342 lm	57,13	100,34
4512.122.xOL	1220	1464 lm	60,71	103,92
4512.132.xOL	1320	1586 lm	64,30	107,51
4512.142.xOL	1420	1708 lm	67,88	111,09
4512.152.xOL	1520	1830 lm	71,47	114,68
4512.162.xOL	1620	1952 lm	75,05	118,26
4512.172.xOL	1720	2074 lm	78,64	121,85
4512.182.xOL	1820	2196 lm	82,22	125,44
4512.192.xOL	1920	2318 lm	85,81	129,02
4512.202.xOL	2020	2440 lm	89,40	132,61
4512.212.xOL	2120	2562 lm	92,98	136,19
4512.222.xOL	2220	2684 lm	96,57	139,78
4512.232.xOL	2320	2806 lm	100,15	143,36
4512.242.xOL	2420	2928 lm	103,74	146,95
4512.252.xOL	2520	3050 lm	107,32	150,53
4512.262.xOL	2620	3172 lm	110,91	154,12
4512.272.xOL	2720	3294 lm	114,49	157,70
4512.282.xOL	2820	3416 lm	118,08	161,29
4512.292.xOL	2920	3538 lm	121,66	164,88

2700K | 3000K | 4000K | 6000K | RGB sob consulta

1-10V sob consulta



1

Branco

código:
4x1x.xxx.10L

2

Cinza

código:
4x1x.xxx.20L

3

Cinza Satinado

código:
4x1x.xxx.30L

7

Grafite

código:
4x1x.xxx.70L

9

Preto

código:
4x1x.xxx.90L

0

RAL sob Consulta

Podem ser instalados em linhas contínuas, com a forma e comprimento solicitados.



4517

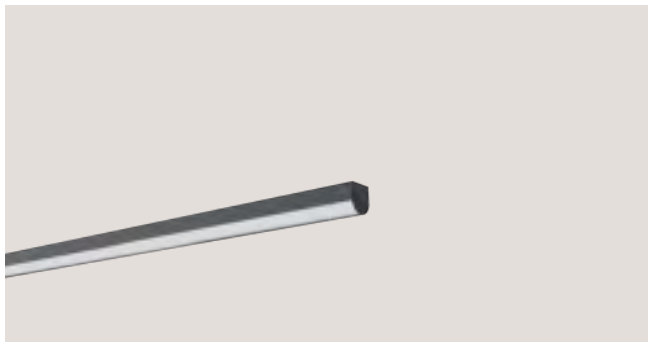

Informação Importante: Driver Remoto Incluído
(não integrado na luminária)

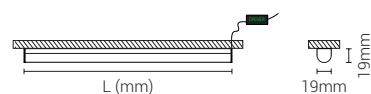

4517 | IK03 | IP40 | Fita LED

Código	L (mm)	Fluxo/Pot. (aprox. 138lm/W)	HF (€) 4517	DALI (€) 4717
4517.051.xOL	510	750 lm	34,47	77,68
4517.061.xOL	610	900 lm	37,90	81,11
4517.071.xOL	710	1050 lm	41,33	84,54
4517.081.xOL	810	1200 lm	44,76	87,97
4517.091.xOL	910	1350 lm	48,19	91,40
4517.101.xOL	1010	1500 lm	51,62	94,83
4517.111.xOL	1110	1650 lm	55,05	98,26
4517.121.xOL	1210	1800 lm	58,48	101,69
4517.131.xOL	1310	1950 lm	61,91	105,12
4517.141.xOL	1410	2100 lm	65,34	108,56
4517.151.xOL	1510	2250 lm	68,78	111,99
4517.161.xOL	1610	2400 lm	72,21	115,42
4517.171.xOL	1710	2550 lm	75,64	118,85
4517.181.xOL	1810	2700 lm	79,07	122,28
4517.191.xOL	1910	2850 lm	82,50	125,71
4517.201.xOL	2010	3000 lm	85,93	129,14
4517.211.xOL	2110	3150 lm	89,36	132,57
4517.221.xOL	2210	3300 lm	92,79	136,00
4517.231.xOL	2310	3450 lm	96,22	139,43
4517.241.xOL	2410	3600 lm	99,65	142,86
4517.251.xOL	2510	3750 lm	103,08	146,30
4517.261.xOL	2610	3900 lm	106,52	149,73
4517.271.xOL	2710	4050 lm	109,95	153,16
4517.281.xOL	2810	4200 lm	113,38	156,59
4517.291.xOL	2910	4350 lm	116,81	160,02

2700K | 3000K | 4000K | 6500K | RGB sob consulta

1-10V sob consulta

4517 | IK03 | IP65 | Driver IP20 | Fita LED

Código	L (mm)	Fluxo/Pot. (aprox. 83,2lm/W)	HF (€) 4517	DALI (€) 4717
4517.052.xOL	520	610 lm	35,61	78,82
4517.062.xOL	620	732 lm	39,20	82,41
4517.072.xOL	720	854 lm	42,78	86,00
4517.082.xOL	820	976 lm	46,37	89,58
4517.092.xOL	920	1098 lm	49,96	93,17
4517.102.xOL	1020	1220 lm	53,54	96,75
4517.112.xOL	1120	1342 lm	57,13	100,34
4517.122.xOL	1220	1464 lm	60,71	103,92
4517.132.xOL	1320	1586 lm	64,30	107,51
4517.142.xOL	1420	1708 lm	67,88	111,09
4517.152.xOL	1520	1830 lm	71,47	114,68
4517.162.xOL	1620	1952 lm	75,05	118,26
4517.172.xOL	1720	2074 lm	78,64	121,85
4517.182.xOL	1820	2196 lm	82,22	125,44
4517.192.xOL	1920	2318 lm	85,81	129,02
4517.202.xOL	2020	2440 lm	89,40	132,61
4517.212.xOL	2120	2562 lm	92,98	136,19
4517.222.xOL	2220	2684 lm	96,57	139,78
4517.232.xOL	2320	2806 lm	100,15	143,36
4517.242.xOL	2420	2928 lm	103,74	146,95
4517.252.xOL	2520	3050 lm	107,32	150,53
4517.262.xOL	2620	3172 lm	110,91	154,12
4517.272.xOL	2720	3294 lm	114,49	157,70
4517.282.xOL	2820	3416 lm	118,08	161,29
4517.292.xOL	2920	3538 lm	121,66	164,88

2700K | 3000K | 4000K | 6000K | RGB sob consulta

1-10V sob consulta



Opalino
código:
4x1x.xxx.xOL





4522



Informação Importante: Driver Remoto Incluído
(não integrado na luminária)

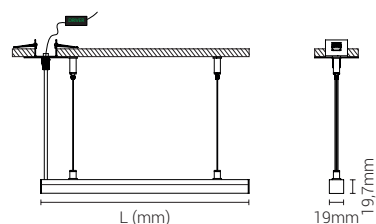

4522 | IK03 | IP40 | Fita LED

Código	L (mm)	Fluxo/Pot. (aprox. 138lm/W)	HF (€)	
			4522	DALI (€) 4722
4522.051.xOL	510	750 lm	46,22	89,43
4522.061.xOL	610	900 lm	49,65	92,86
4522.071.xOL	710	1050 lm	53,08	96,29
4522.081.xOL	810	1200 lm	56,51	99,72
4522.091.xOL	910	1350 lm	59,94	103,15
4522.101.xOL	1010	1500 lm	63,37	106,58
4522.111.xOL	1110	1650 lm	66,80	110,01
4522.121.xOL	1210	1800 lm	70,23	113,44
4522.131.xOL	1310	1950 lm	73,66	116,87
4522.141.xOL	1410	2100 lm	77,09	120,31
4522.151.xOL	1510	2250 lm	80,53	123,74
4522.161.xOL	1610	2400 lm	83,96	127,17
4522.171.xOL	1710	2550 lm	87,39	130,60
4522.181.xOL	1810	2700 lm	90,82	134,03
4522.191.xOL	1910	2850 lm	94,25	137,46
4522.201.xOL	2010	3000 lm	97,68	140,89
4522.211.xOL	2110	3150 lm	101,11	144,32
4522.221.xOL	2210	3300 lm	104,54	147,75
4522.231.xOL	2310	3450 lm	107,97	151,18
4522.241.xOL	2410	3600 lm	111,40	154,61
4522.251.xOL	2510	3750 lm	114,83	158,05
4522.261.xOL	2610	3900 lm	118,27	161,48
4522.271.xOL	2710	4050 lm	121,70	164,91
4522.281.xOL	2810	4200 lm	125,13	168,34
4522.291.xOL	2910	4350 lm	128,56	171,77

2700K | 3000K | 4000K | 6500K | RGB sob consulta

1-10V sob consulta

4522 | IK03 | IP65 | Driver IP20 | Fita LED

Código	L (mm)	Fluxo/Pot. (aprox. 83,2lm/W)	HF (€)	
			4522	DALI (€) 4722
4522.052.xOL	520	610 lm	47,36	90,57
4522.062.xOL	620	732 lm	50,95	94,16
4522.072.xOL	720	854 lm	54,53	97,75
4522.082.xOL	820	976 lm	58,12	101,33
4522.092.xOL	920	1098 lm	61,71	104,92
4522.102.xOL	1020	1220 lm	65,29	108,50
4522.112.xOL	1120	1342 lm	68,88	112,09
4522.122.xOL	1220	1464 lm	72,46	115,67
4522.132.xOL	1320	1586 lm	76,05	119,26
4522.142.xOL	1420	1708 lm	79,63	122,84
4522.152.xOL	1520	1830 lm	83,22	126,43
4522.162.xOL	1620	1952 lm	86,80	130,01
4522.172.xOL	1720	2074 lm	90,39	133,60
4522.182.xOL	1820	2196 lm	93,97	137,19
4522.192.xOL	1920	2318 lm	97,56	140,77
4522.202.xOL	2020	2440 lm	101,15	144,36
4522.212.xOL	2120	2562 lm	104,73	147,94
4522.222.xOL	2220	2684 lm	108,32	151,53
4522.232.xOL	2320	2806 lm	111,90	155,11
4522.242.xOL	2420	2928 lm	115,49	158,70
4522.252.xOL	2520	3050 lm	119,07	162,28
4522.262.xOL	2620	3172 lm	122,66	165,87
4522.272.xOL	2720	3294 lm	126,24	169,45
4522.282.xOL	2820	3416 lm	129,83	173,04
4522.292.xOL	2920	3538 lm	133,41	176,63

2700K | 3000K | 4000K | 6000K | RGB sob consulta

1-10V sob consulta

Acessórios

1 2 7 9

Standard/Incluído

Opção



5184.FER.xXX
Florão Encastrado
Redondo Ø80mm



5184.FEQ.xXX
Florão Encastrado
Quadrado 80x80mm
9,45€



5084.CDR.xXX
Caixa para Driver
16,97€



5084.COS.xXX
Cabos de Suspensão
Standard/Incluído
1,5 metros
5084.xAx.xXX
Cabo de Alimentação
Standard/Incluído
1,5 metros
Outras Medidas na
Página 243



1

Branco

código:
4x2x.xxx.10L

2

Cinza

código:
4x2x.xxx.20L

3

Cinza Satinado

código:
4x2x.xxx.30L

7

Grafite

código:
4x2x.xxx.70L

9

Preto

código:
4x2x.xxx.90L

0

RAL sob Consulta

Podem ser instalados em linhas contínuas, com a forma e comprimento solicitados.



4527

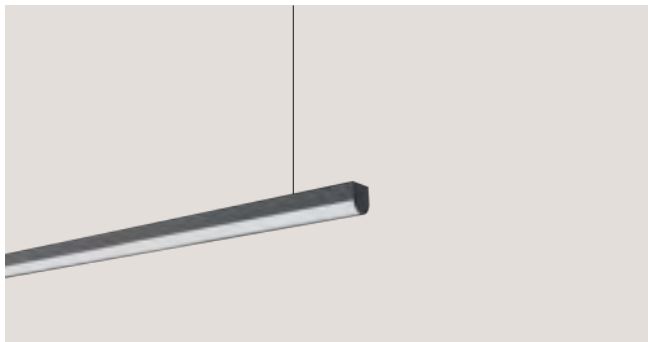

Informação Importante: Driver Remoto Incluído
(não integrado na luminária)

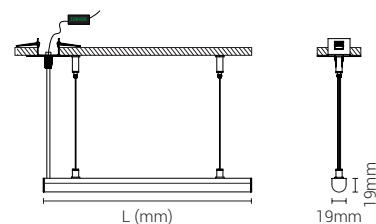

4527 | IK03 | IP40 | Fita LED

Código	L (mm)	Fluxo/Pot. (aprox. 138lm/W)	HF (€) 4527	DALI (€) 4727
4527.051.xOL	510	750 lm	46,22	89,43
4527.061.xOL	610	900 lm	49,65	92,86
4527.071.xOL	710	1050 lm	53,08	96,29
4527.081.xOL	810	1200 lm	56,51	99,72
4527.091.xOL	910	1350 lm	59,94	103,15
4527.101.xOL	1010	1500 lm	63,37	106,58
4527.111.xOL	1110	1650 lm	66,80	110,01
4527.121.xOL	1210	1800 lm	70,23	113,44
4527.131.xOL	1310	1950 lm	73,66	116,87
4527.141.xOL	1410	2100 lm	77,09	120,31
4527.151.xOL	1510	2250 lm	80,53	123,74
4527.161.xOL	1610	2400 lm	83,96	127,17
4527.171.xOL	1710	2550 lm	87,39	130,60
4527.181.xOL	1810	2700 lm	90,82	134,03
4527.191.xOL	1910	2850 lm	94,25	137,46
4527.201.xOL	2010	3000 lm	97,68	140,89
4527.211.xOL	2110	3150 lm	101,11	144,32
4527.221.xOL	2210	3300 lm	104,54	147,75
4527.231.xOL	2310	3450 lm	107,97	151,18
4527.241.xOL	2410	3600 lm	111,40	154,61
4527.251.xOL	2510	3750 lm	114,83	158,05
4527.261.xOL	2610	3900 lm	118,27	161,48
4527.271.xOL	2710	4050 lm	121,70	164,91
4527.281.xOL	2810	4200 lm	125,13	168,34
4527.291.xOL	2910	4350 lm	128,56	171,77

2700K | 3000K | 4000K | 6500K | RGB sob consulta

1-10V sob consulta

4527 | IK03 | IP65 | Driver IP20 | Fita LED

Código	L (mm)	Fluxo/Pot. (aprox. 83,2lm/W)	HF (€) 4527	DALI (€) 4727
4527.052.xOL	520	610 lm	47,36	90,57
4527.062.xOL	620	732 lm	50,95	94,16
4527.072.xOL	720	854 lm	54,53	97,75
4527.082.xOL	820	976 lm	58,12	101,33
4527.092.xOL	920	1098 lm	61,71	104,92
4527.102.xOL	1020	1220 lm	65,29	108,50
4527.112.xOL	1120	1342 lm	68,88	112,09
4527.122.xOL	1220	1464 lm	72,46	115,67
4527.132.xOL	1320	1586 lm	76,05	119,26
4527.142.xOL	1420	1708 lm	79,63	122,84
4527.152.xOL	1520	1830 lm	83,22	126,43
4527.162.xOL	1620	1952 lm	86,80	130,01
4527.172.xOL	1720	2074 lm	90,39	133,60
4527.182.xOL	1820	2196 lm	93,97	137,19
4527.192.xOL	1920	2318 lm	97,56	140,77
4527.202.xOL	2020	2440 lm	101,15	144,36
4527.212.xOL	2120	2562 lm	104,73	147,94
4527.222.xOL	2220	2684 lm	108,32	151,53
4527.232.xOL	2320	2806 lm	111,90	155,11
4527.242.xOL	2420	2928 lm	115,49	158,70
4527.252.xOL	2520	3050 lm	119,07	162,28
4527.262.xOL	2620	3172 lm	122,66	165,87
4527.272.xOL	2720	3294 lm	126,24	169,45
4527.282.xOL	2820	3416 lm	129,83	173,04
4527.292.xOL	2920	3538 lm	133,41	176,63

2700K | 3000K | 4000K | 6000K | RGB sob consulta

1-10V sob consulta



Opalino

código:
4x2x.xxx.xOL





4011



4011 IK06 IP40 Módulo LED					
Código	L (mm)	Fluxo/Pot. (aprox. 183lm/W)	HF (€) 4011	1-10V (€) 4111	DALI (€) 4211
4011.029.10L	290	1100 lm	36,07	-	-
4011.043.10L	430	1650 lm	44,37	-	-
4011.057.10L	570	2200 lm	48,08	73,70	75,81
4011.071.10L	710	2750 lm	65,00	82,00	84,11
4011.085.10L	850	3300 lm	70,86	87,86	89,96
4011.099.10L	990	3850 lm	79,16	96,16	98,26
4011.113.10L	1130	4400 lm	82,87	99,87	101,97
4011.127.10L	1270	4950 lm	91,33	108,17	110,74
4011.141.10L	1410	5500 lm	97,18	114,03	116,59
4011.155.10L	1550	6050 lm	105,48	122,33	124,89
4011.169.10L	1690	6600 lm	109,19	126,04	128,60
4011.183.10L	1830	7150 lm	117,49	134,34	136,90
4011.197.10L	1970	7700 lm	123,35	140,20	142,76
4011.211.10L	2110	8250 lm	131,65	148,50	151,06
4011.225.10L	2250	8800 lm	135,36	152,21	154,77
4011.239.10L	2390	9350 lm	156,49	196,58	184,71
4011.253.10L	2530	9900 lm	162,35	202,43	190,57
4011.267.10L	2670	10450 lm	170,65	210,73	198,87
4011.281.10L	2810	11000 lm	174,35	214,44	202,57
4011.295.10L	2950	11550 lm	182,65	222,74	210,87
4011.309.10L	3090	12100 lm	188,51	228,60	216,73
4011.323.10L	3230	12650 lm	196,81	236,90	225,03
4011.337.10L	3370	13200 lm	200,52	240,61	228,74
4011.351.10L	3510	13750 lm	218,87	248,91	254,04
4011.365.10L	3650	14300 lm	224,72	254,77	259,90
4011.379.10L	3790	14850 lm	233,02	263,07	268,20
4011.393.10L	3930	15400 lm	236,73	266,78	271,91
4011.407.10L	4070	15950 lm	245,03	275,08	280,21
4011.421.10L	4210	16500 lm	250,89	280,94	286,07
4011.435.10L	4350	17050 lm	259,19	289,24	294,37
4011.449.10L	4490	17600 lm	262,90	292,94	298,08
4011.463.10L	4630	18150 lm	284,03	337,32	328,01
4011.477.10L	4770	18700 lm	289,89	343,17	333,87
4011.491.10L	4910	19250 lm	298,19	351,47	342,17
4011.505.10L	5050	19800 lm	301,90	355,18	345,88

2700K | 3000K | 4000K | 6500K



1

Branco

código:
4x1x.xxx.10L

2

Cinza

código:
4x1x.xxx.20L

3

Cinza Satinado

código:
4x1x.xxx.30L

4

Escovado

código:
4x1x.xxx.40L

7

Grafite

código:
4x1x.xxx.70L

9

Preto

código:
4x1x.xxx.90L

0

RAL sob Consulta

Pode ser instalado em linhas contínuas, com a forma e comprimento solicitados.



4012 | 4013

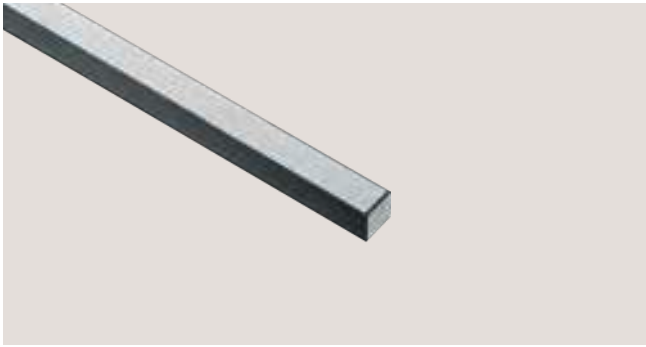

Informação Importante: Driver Remoto Incluído
(não integrado na luminária)

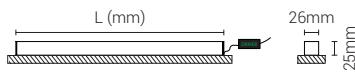

4012 IK04 IP40 Módulo LED					
Código	L (mm)	Fluxo/Pot. (aprox. 184lm/W)	HF (€) 4012	1-10V (€) 4112	DALI (€) 4212
4012.015.xOL	150	490 lm	28,09	-	-
4012.029.xOL	290	980 lm	32,65	-	-
4012.043.xOL	430	1470 lm	39,34	-	-
4012.057.xOL	570	1960 lm	42,71	73,15	73,40
4012.071.xOL	710	2450 lm	58,02	79,84	80,09
4012.085.xOL	850	2940 lm	62,58	84,40	84,65
4012.099.xOL	990	3430 lm	69,27	91,10	91,34
4012.113.xOL	1130	3920 lm	72,64	94,46	94,71
4012.127.xOL	1270	4410 lm	79,33	101,16	101,40
4012.141.xOL	1410	4900 lm	83,89	108,28	105,96
4012.155.xOL	1550	5390 lm	90,71	115,10	112,78
4012.169.xOL	1690	5880 lm	94,08	118,47	116,15
4012.183.xOL	1830	6370 lm	100,92	125,16	122,84
4012.197.xOL	1970	6860 lm	105,48	129,72	127,40
4012.211.xOL	2110	7350 lm	112,18	136,41	134,09
4012.225.xOL	2250	7840 lm	115,54	139,78	137,46
4012.239.xOL	2390	8330 lm	122,24	146,47	144,15
4012.253.xOL	2530	8820 lm	126,80	151,03	148,71
4012.267.xOL	2670	9310 lm	133,49	157,72	155,40
4012.281.xOL	2810	9800 lm	136,86	161,16	158,77
4012.295.xOL	2950	10290 lm	143,55	168,85	165,45
4012.309.xOL	3090	10780 lm	148,11	173,41	170,02
4012.323.xOL	3230	11270 lm	154,92	179,10	176,84
4012.337.xOL	3370	11760 lm	171,12	221,16	205,24
4012.351.xOL	3510	12250 lm	177,81	227,85	211,93

2700K | 3000K | 4000K | 5000K | 6500K

4013 IK04 IP40 Fita LED				
Código	L (mm)	Fluxo/Pot. (aprox. 138lm/W)	HF (€) 4013	DALI (€) 4213
4013.051.xOL	510	750 lm	41,63	92,41
4013.061.xOL	610	900 lm	46,09	96,88
4013.071.xOL	710	1050 lm	50,56	101,34
4013.081.xOL	810	1200 lm	55,02	105,81
4013.091.xOL	910	1350 lm	59,49	110,27
4013.101.xOL	1010	1500 lm	63,96	114,74
4013.111.xOL	1110	1650 lm	68,42	119,21
4013.121.xOL	1210	1800 lm	72,89	123,67
4013.131.xOL	1310	1950 lm	77,36	128,14
4013.141.xOL	1410	2100 lm	81,82	132,61
4013.151.xOL	1510	2250 lm	86,29	137,07
4013.161.xOL	1610	2400 lm	90,76	141,54
4013.171.xOL	1710	2550 lm	95,22	146,01
4013.181.xOL	1810	2700 lm	99,69	150,47
4013.191.xOL	1910	2850 lm	104,15	154,94
4013.201.xOL	2010	3000 lm	108,62	159,40
4013.211.xOL	2110	3150 lm	113,09	163,87
4013.221.xOL	2210	3300 lm	117,55	168,34
4013.231.xOL	2310	3450 lm	122,02	172,80
4013.241.xOL	2410	3600 lm	126,49	177,27
4013.251.xOL	2510	3750 lm	130,95	181,74
4013.261.xOL	2610	3900 lm	135,42	186,20
4013.271.xOL	2710	4050 lm	139,89	190,67
4013.281.xOL	2810	4200 lm	144,35	195,14
4013.291.xOL	2910	4350 lm	148,82	199,60
4013.301.xOL	3010	4500 lm	153,29	204,07

2700K | 3000K | 4000K | 6500K | RGB sob consulta

1-10V sob consulta

4013 IK04 IP65 Driver IP20 Fita LED				
Código	L (mm)	Fluxo/Pot. (aprox. 83,2lm/W)	HF (€) 4013	DALI (€) 4213
4013.052.xOL	520	610 lm	43,17	93,95
4013.062.xOL	620	732 lm	47,95	98,73
4013.072.xOL	720	854 lm	52,72	103,51
4013.082.xOL	820	976 lm	57,50	108,28
4013.092.xOL	920	1098 lm	62,27	113,06
4013.102.xOL	1020	1220 lm	67,05	117,83
4013.112.xOL	1120	1342 lm	71,82	122,61
4013.122.xOL	1220	1464 lm	76,60	127,38
4013.132.xOL	1320	1586 lm	81,37	132,16
4013.142.xOL	1420	1708 lm	86,15	136,93
4013.152.xOL	1520	1830 lm	90,93	141,71
4013.162.xOL	1620	1952 lm	95,70	146,48
4013.172.xOL	1720	2074 lm	100,48	151,26
4013.182.xOL	1820	2196 lm	105,25	156,04
4013.192.xOL	1920	2318 lm	110,03	160,81
4013.202.xOL	2020	2440 lm	114,80	165,59
4013.212.xOL	2120	2562 lm	119,58	170,36
4013.222.xOL	2220	2684 lm	124,35	175,14
4013.232.xOL	2320	2806 lm	129,13	179,91
4013.242.xOL	2420	2928 lm	133,90	184,69
4013.252.xOL	2520	3050 lm	138,68	189,46
4013.262.xOL	2620	3172 lm	143,46	194,24
4013.272.xOL	2720	3294 lm	148,23	199,01
4013.282.xOL	2820	3416 lm	153,01	203,79
4013.292.xOL	2920	3538 lm	157,79	208,56
4013.302.xOL	3020	3660 lm	162,57	213,34

2700K | 3000K | 4000K | 6000K | RGB sob consulta

1-10V sob consulta



Opalino
código:
4x1x.xxx.xOL





4515

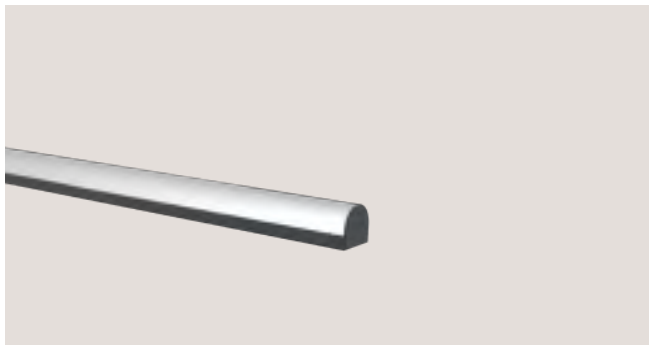

Informação Importante: Driver Remoto Incluído
(não integrado na luminária)



4515 IK03 IP40 Fita LED				
Código	L (mm)	Fluxo/Pot. (aprox. 138lm/W)	HF (€) 4515	DALI (€) 4715
4515.051.xOL	510	750 lm	33,54	76,75
4515.061.xOL	610	900 lm	36,79	80,00
4515.071.xOL	710	1050 lm	40,04	83,25
4515.081.xOL	810	1200 lm	43,29	86,50
4515.091.xOL	910	1350 lm	46,54	89,75
4515.101.xOL	1010	1500 lm	49,78	93,00
4515.111.xOL	1110	1650 lm	53,03	96,24
4515.121.xOL	1210	1800 lm	56,28	99,49
4515.131.xOL	1310	1950 lm	59,53	102,74
4515.141.xOL	1410	2100 lm	62,78	105,99
4515.151.xOL	1510	2250 lm	66,03	109,24
4515.161.xOL	1610	2400 lm	69,28	112,49
4515.171.xOL	1710	2550 lm	72,53	115,74
4515.181.xOL	1810	2700 lm	75,78	118,99
4515.191.xOL	1910	2850 lm	79,03	122,24
4515.201.xOL	2010	3000 lm	82,28	125,49
4515.211.xOL	2110	3150 lm	85,52	128,74
4515.221.xOL	2210	3300 lm	88,77	131,98
4515.231.xOL	2310	3450 lm	92,02	135,23
4515.241.xOL	2410	3600 lm	95,27	138,48
4515.251.xOL	2510	3750 lm	98,52	141,73
4515.261.xOL	2610	3900 lm	101,77	144,98
4515.271.xOL	2710	4050 lm	105,02	148,23
4515.281.xOL	2810	4200 lm	108,27	151,48
4515.291.xOL	2910	4350 lm	111,52	154,73

2700K | 3000K | 4000K | 6500K | RGB sob consulta

1-10V sob consulta

4515 IK03 IP65 Driver IP20 Fita LED				
Código	L (mm)	Fluxo/Pot. (aprox. 83,2lm/W)	HF (€) 4515	DALI (€) 4715
4515.052.xOL	520	610 lm	35,61	78,82
4515.062.xOL	620	732 lm	39,20	82,41
4515.072.xOL	720	854 lm	42,78	86,00
4515.082.xOL	820	976 lm	46,37	89,58
4515.092.xOL	920	1098 lm	49,96	93,17
4515.102.xOL	1020	1220 lm	53,54	96,75
4515.112.xOL	1120	1342 lm	57,13	100,34
4515.122.xOL	1220	1464 lm	60,71	103,92
4515.132.xOL	1320	1586 lm	64,30	107,51
4515.142.xOL	1420	1708 lm	67,88	111,09
4515.152.xOL	1520	1830 lm	71,47	114,68
4515.162.xOL	1620	1952 lm	75,05	118,26
4515.172.xOL	1720	2074 lm	78,64	121,85
4515.182.xOL	1820	2196 lm	82,22	125,44
4515.192.xOL	1920	2318 lm	85,81	129,02
4515.202.xOL	2020	2440 lm	89,40	132,61
4515.212.xOL	2120	2562 lm	92,98	136,19
4515.222.xOL	2220	2684 lm	96,57	139,78
4515.232.xOL	2320	2806 lm	100,15	143,36
4515.242.xOL	2420	2928 lm	103,74	146,95
4515.252.xOL	2520	3050 lm	107,32	150,53
4515.262.xOL	2620	3172 lm	110,91	154,12
4515.272.xOL	2720	3294 lm	114,49	157,70
4515.282.xOL	2820	3416 lm	118,08	161,29
4515.292.xOL	2920	3538 lm	121,66	164,88

2700K | 3000K | 4000K | 6000K | RGB sob consulta

1-10V sob consulta



1

Branco

código:
4x1x.xxx.10L

2

Cinza

código:
4x1x.xxx.20L

3

Cinza Satinado

código:
4x1x.xxx.30L

9

Preto

código:
4x1x.xxx.90L

0

RAL sob Consulta

Podem ser instalados em linhas contínuas, com a forma e comprimento solicitados.



4516

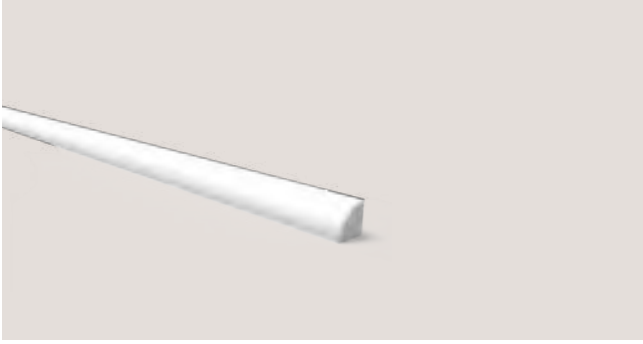

Informação Importante: Driver Remoto Incluído
(não integrado na luminária)

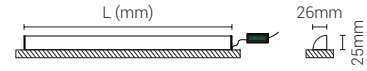

4516 | IK03 | IP40 | Fita LED

Código	L (mm)	Fluxo/Pot. (aprox. 138lm/W)	HF (€) 4516	DALI (€) 4716
4516.051.xOL	510	750 lm	33,54	76,75
4516.061.xOL	610	900 lm	36,79	80,00
4516.071.xOL	710	1050 lm	40,04	83,25
4516.081.xOL	810	1200 lm	43,29	86,50
4516.091.xOL	910	1350 lm	46,54	89,75
4516.101.xOL	1010	1500 lm	49,78	93,00
4516.111.xOL	1110	1650 lm	53,03	96,24
4516.121.xOL	1210	1800 lm	56,28	99,49
4516.131.xOL	1310	1950 lm	59,53	102,74
4516.141.xOL	1410	2100 lm	62,78	105,99
4516.151.xOL	1510	2250 lm	66,03	109,24
4516.161.xOL	1610	2400 lm	69,28	112,49
4516.171.xOL	1710	2550 lm	72,53	115,74
4516.181.xOL	1810	2700 lm	75,78	118,99
4516.191.xOL	1910	2850 lm	79,03	122,24
4516.201.xOL	2010	3000 lm	82,28	125,49
4516.211.xOL	2110	3150 lm	85,52	128,74
4516.221.xOL	2210	3300 lm	88,77	131,98
4516.231.xOL	2310	3450 lm	92,02	135,23
4516.241.xOL	2410	3600 lm	95,27	138,48
4516.251.xOL	2510	3750 lm	98,52	141,73
4516.261.xOL	2610	3900 lm	101,77	144,98
4516.271.xOL	2710	4050 lm	105,02	148,23
4516.281.xOL	2810	4200 lm	108,27	151,48
4516.291.xOL	2910	4350 lm	111,52	154,73

2700K | 3000K | 4000K | 6500K | RGB sob consulta

1-10V sob consulta

4516 | IK03 | IP65 | Driver IP20 | Fita LED

Código	L (mm)	Fluxo/Pot. (aprox. 83,2lm/W)	HF (€) 4516	DALI (€) 4716
4516.052.xOL	520	610 lm	35,61	78,82
4516.062.xOL	620	732 lm	39,20	82,41
4516.072.xOL	720	854 lm	42,78	86,00
4516.082.xOL	820	976 lm	46,37	89,58
4516.092.xOL	920	1098 lm	49,96	93,17
4516.102.xOL	1020	1220 lm	53,54	96,75
4516.112.xOL	1120	1342 lm	57,13	100,34
4516.122.xOL	1220	1464 lm	60,71	103,92
4516.132.xOL	1320	1586 lm	64,30	107,51
4516.142.xOL	1420	1708 lm	67,88	111,09
4516.152.xOL	1520	1830 lm	71,47	114,68
4516.162.xOL	1620	1952 lm	75,05	118,26
4516.172.xOL	1720	2074 lm	78,64	121,85
4516.182.xOL	1820	2196 lm	82,22	125,44
4516.192.xOL	1920	2318 lm	85,81	129,02
4516.202.xOL	2020	2440 lm	89,40	132,61
4516.212.xOL	2120	2562 lm	92,98	136,19
4516.222.xOL	2220	2684 lm	96,57	139,78
4516.232.xOL	2320	2806 lm	100,15	143,36
4516.242.xOL	2420	2928 lm	103,74	146,95
4516.252.xOL	2520	3050 lm	107,32	150,53
4516.262.xOL	2620	3172 lm	110,91	154,12
4516.272.xOL	2720	3294 lm	114,49	157,70
4516.282.xOL	2820	3416 lm	118,08	161,29
4516.292.xOL	2920	3538 lm	121,66	164,88

2700K | 3000K | 4000K | 6000K | RGB sob consulta

1-10V sob consulta

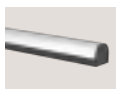

Opalino

código:
4x1x.xxx.xOL





Tubulares

Luminária suspensa vertical, projeção de luz 360°



4567 Pag. 68 4571 Pag. 68

Luminária suspensa horizontal, projeção de luz 300° ou 360°

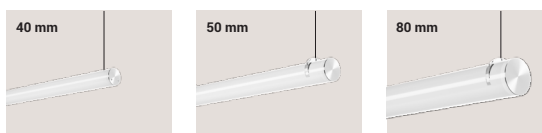

4573 Pag. 72 4565 Pag. 69 4569 Pag. 69

Luminária suspensa horizontal, projeção de luz descendente

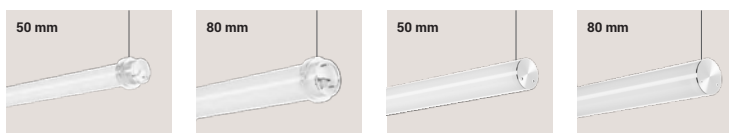

4065 Pag. 70 4069 Pag. 70 4067 Pag. 71 4071 Pag. 71

Luminária saliente, projeção de luz 300° ou 360°

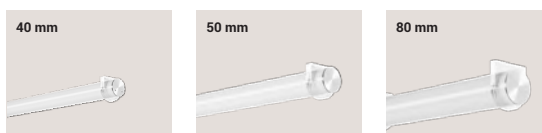

4572 Pag. 72 4564 Pag. 73 4568 Pag. 73

Luminária saliente, projeção de luz descendente



4064 Pag. 74 4068 Pag. 74 4066 Pag. 75 4070 Pag. 75



4567



Informação Importante: Driver Remoto Incluído
(não integrado na luminária)

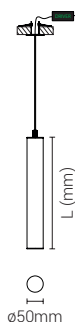

4571



Informação Importante: Driver Remoto Incluído
(não integrado na luminária)

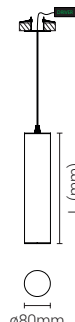

4567 | IK07 | IP43 | Fita LED

Código	L (mm)	Fluxo/Pot. (aprox. 141lm/W)	HF (€) 4567	1-10V (€) 4667	DALI (€) 4767
4567.055.xFL	550	2000 lm	104,16	120,70	152,26
4567.105.xFL	1050	4000 lm	138,50	155,04	186,60
4567.155.xFL	1550	6000 lm	185,11	194,57	226,13
4567.205.xFL	2050	8000 lm	225,11	234,57	266,13

2700K | 3000K | 4000K

4571 | IK07 | IP43 | Fita LED

Código	L (mm)	Fluxo/Pot. (aprox. 138lm/W)	HF (€) 4571	1-10V (€) 4671	DALI (€) 4771
4571.055.xFL	550	3000 lm	121,13	137,67	169,23
4571.105.xFL	1050	6000 lm	167,84	177,29	208,85
4571.155.xFL	1550	9000 lm	225,98	236,45	269,53
4571.205.xFL	2050	12000 lm	272,15	282,63	315,71

2700K | 3000K | 4000K

Acessórios

1 2 7 9

Standard/Incluído



5184.FER.xXX
Florão Encastrado Redondo Ø80mm

Opção - Driver Incorporado



5084.CDT.xXX
Caixa p/ Driver Ø50mm
45,45€
5184.CDT.xXX
Caixa p/ Driver Ø80mm
49,09€



Opção - Driver Incorporado



5084.FER.xXX
5184.FER.xXX
Florão Encastrado +



5084.CDT.xXX
5184.CDT.xXX
Caixa p/ Driver



4064.MFI.050
Abraçadeira Inox Ø50mm
3,97€
4068.MFI.080
Abraçadeira Inox Ø80mm
4,72€



5184.CDR.xXX
Caixa para Driver
16,97€



5084.COS.xXX
Cabos de Suspensão Standard/Incluído 1,5m
5084.xAx.xXX
Cabo de Alimentação Standard/Incluído 1,5m
Outras Medidas na Página 243

As opções com caixa para driver só são possíveis para medidas até 1550mm.

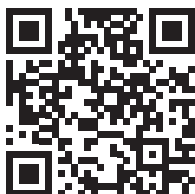

1

Branco

código:
4xxx.xxx.1FL

2

Cinza

código:
4xxx.xxx.2FL

4

Escovado

código:
4xxx.xxx.4FL

7

Grafite

código:
4xxx.xxx.7FL

9

Preto

código:
4xxx.xxx.9FL

0

RAL sob Consulta

Outras medidas sob consulta.



4565

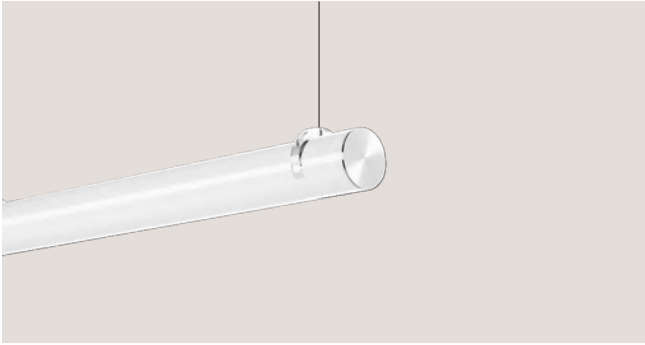

Informação Importante: Driver Remoto Incluído
(não integrado na luminária)

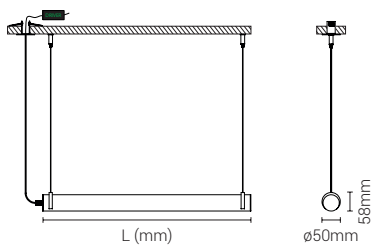

4569

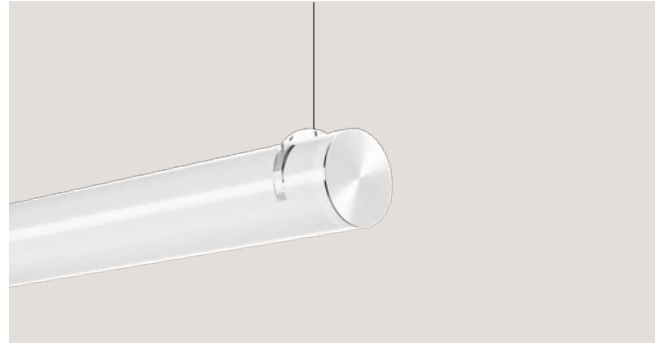

Informação Importante: Driver Remoto Incluído
(não integrado na luminária)

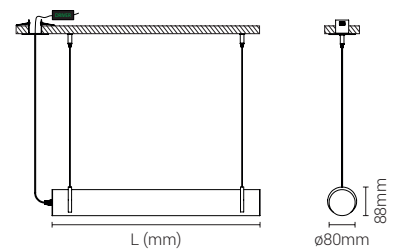

4565 | IK07 | IP43 | Fita LED

Código	L (mm)	Fluxo/Pot. (aprox. 141lm/W)	HF (€) 4565	1-10V (€) 4665	DALI (€) 4765
4565.055.xFL	550	2000 lm	115,35	131,89	163,45
4565.105.xFL	1050	4000 lm	149,69	166,23	197,79
4565.155.xFL	1550	6000 lm	196,30	205,76	237,32
4565.205.xFL	2050	8000 lm	236,30	245,76	277,32

2700K | 3000K | 4000K

4569 | IK07 | IP43 | Fita LED

Code	L (mm)	Fluxo/Pot. (aprox. 138lm/W)	HF (€) 4569	1-10V (€) 4669	DALI (€) 4769
4569.055.xFL	550	3000 lm	132,32	148,86	180,42
4569.105.xFL	1050	6000 lm	179,03	188,48	220,04
4569.155.xFL	1550	9000 lm	237,17	247,64	280,72
4569.205.xFL	2050	12000 lm	283,34	293,82	326,89

2700K | 3000K | 4000K



Fosco
código:
4xxx.xxx.xFL





4065

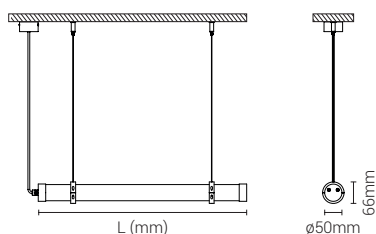
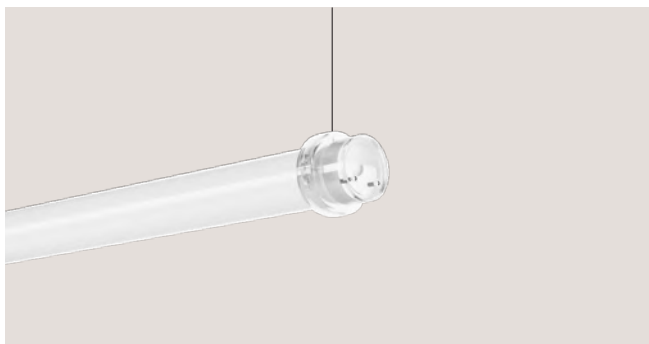

4069

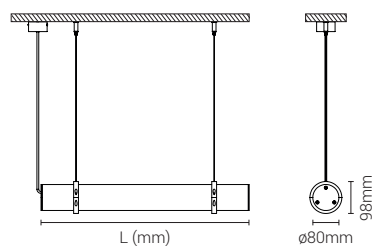

4065 | IK10 | IP65 | Módulo LED

Código	L (mm)	Fluxo/Pot. (aprox. 183lm/W)	HF (€)		
			4065	1-10V (€) 4165	DALI (€) 4265
4065.035.PxL	355	1300 lm	68,97	-	-
4065.063.PxL	635	2600 lm	79,38	-	-
4065.091.PxL	915	3900 lm	100,60	124,62	122,76
4065.119.PxL	1195	5200 lm	111,40	135,41	133,56
4065.147.PxL	1475	6500 lm	125,22	149,54	147,23
4065.175.PxL	1755	7800 lm	136,20	160,52	158,21
4065.203.PxL	2035	9100 lm	153,79	178,12	175,80
4065.231.PxL	2315	10400 lm	165,42	189,75	187,43
4065.259.PxL	2595	11700 lm	193,48	243,61	227,69
4065.287.PxL	2875	13000 lm	207,85	257,99	242,07

2700K | 3000K | 4000K | 5000K | 6500K

4069 | IK07 | IP65 | Módulo LED

Código	L (mm)	Fluxo/Pot. (aprox. 183lm/W)	HF (€)		
			4069	1-10V (€) 4169	DALI (€) 4269
4069.037.PxL	376	1300 lm	83,50	-	-
4069.065.PxL	656	2600 lm	96,12	-	-
4069.093.PxL	936	3900 lm	121,48	145,50	143,65
4069.121.PxL	1216	5200 lm	134,93	158,95	157,09
4069.149.PxL	1496	6500 lm	151,41	175,73	173,41
4069.177.PxL	1776	7800 lm	165,84	190,17	187,85
4069.205.PxL	2056	9100 lm	188,06	212,39	210,07
4069.233.PxL	2336	10400 lm	199,53	223,86	221,54
4069.261.PxL	2616	11700 lm	228,31	278,44	262,52
4069.289.PxL	2896	13000 lm	244,29	294,42	278,50

2700K | 3000K | 4000K | 5000K | 6500K

Acessórios

1 2 7 9

Standard/Incluído

Opção

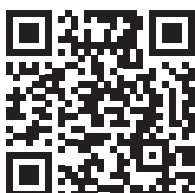
5084.FSR.xXX
Florão Saliente
Redondo Ø58mm5084.FER.xXX
Florão Encastrado
Redondo Ø55mm
8,77€4064.MFI.050
Abraçadeira Inox
Ø50mm
3,97€
4068.MFI.080
Abraçadeira Inox
Ø80mm
4,72€5084.COS.xXX
Cabos de Suspensão
Standard/Incluído 1,5m
5084.xAx.xXX
Cabo de Alimentação
Standard/Incluído 1,5m
Outras Medidas
na Página 243

P

Polycarbonato

código:
4x6x.xxx.PxL

1

Branco

código:
4xxx.xxx.1xL

2

Cinza

código:
4xxx.xxx.2xL

4

Escovado

código:
4xxx.xxx.4xL

7

Grafite

código:
4xxx.xxx.7xL

9

Preto

código:
4xxx.xxx.9xL

0

RAL sob Consulta

Outras medidas sob consulta.



4067

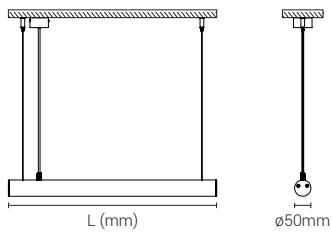
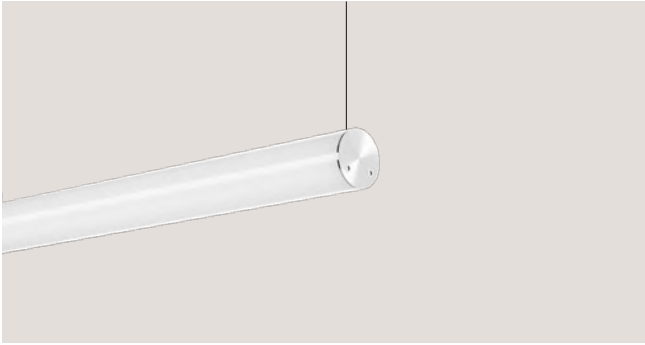

4071

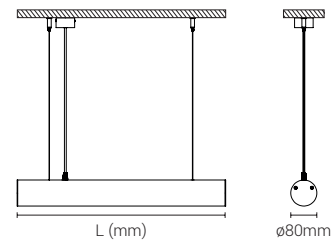

4067 | IK10 | IP43 | Módulo LED

Código	L (mm)	Fluxo/Pot. (aprox. 183lm/W)	HF (€) 4067	1-10V (€) 4167	DALI (€) 4267
4067.033.xxL	338	1300 lm	69,99	-	-
4067.061.xxL	618	2600 lm	80,40	-	-
4067.089.xxL	898	3900 lm	101,62	125,64	123,78
4067.117.xxL	1178	5200 lm	112,42	136,43	134,58
4067.145.xxL	1458	6500 lm	126,24	150,56	148,25
4067.173.xxL	1738	7800 lm	137,22	161,54	159,23
4067.201.xxL	2018	9100 lm	154,81	179,14	176,82
4067.229.xxL	2298	10400 lm	166,44	190,77	188,45
4067.257.xxL	2578	11700 lm	194,50	244,63	228,71
4067.285.xxL	2858	13000 lm	208,87	259,01	243,09

2700K | 3000K | 4000K | 5000K | 6500K

4071 | IK07 | IP43 | Módulo LED

Código	L (mm)	Fluxo/Pot. (aprox. 183lm/W)	HF (€) 4071	1-10V (€) 4171	DALI (€) 4271
4071.035.xxL	354	1300 lm	92,34	-	-
4071.063.xxL	634	2600 lm	104,96	-	-
4071.091.xxL	914	3900 lm	130,32	154,34	152,49
4071.119.xxL	1194	5200 lm	143,77	167,79	165,93
4071.147.xxL	1474	6500 lm	160,25	184,57	182,25
4071.175.xxL	1754	7800 lm	174,68	199,01	196,69
4071.203.xxL	2034	9100 lm	196,90	221,23	218,91
4071.231.xxL	2314	10400 lm	208,37	232,70	230,38
4071.259.xxL	2594	11700 lm	237,15	287,28	271,36
4071.287.xxL	2874	13000 lm	253,13	303,26	287,34

2700K | 3000K | 4000K | 5000K | 6500K

Fosco
código:
4xxx.xxx.xFLTransparente
código:
4xxx.xxx.xTL

81,29€

104,78€

Estas luminárias podem incluir estes componentes elétricos a partir de 1130mm.





40 mm | Luminária suspensa ou luminária saliente de teto/parede com emissão de fluxo 200°

4573

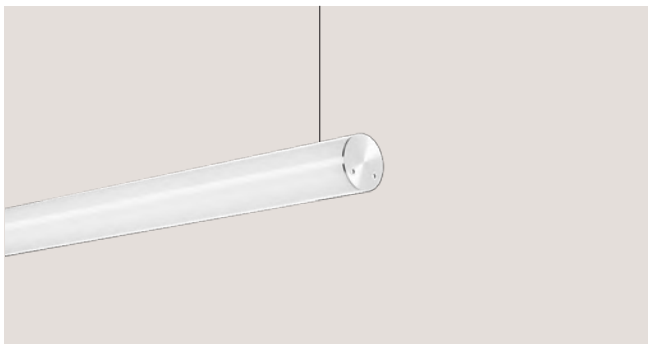

Informação Importante: Driver Remoto Incluído
(não integrado na luminária)

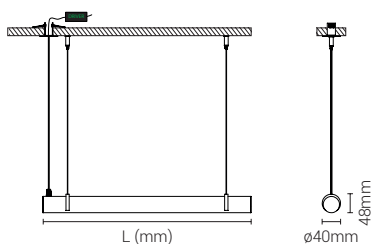

4572

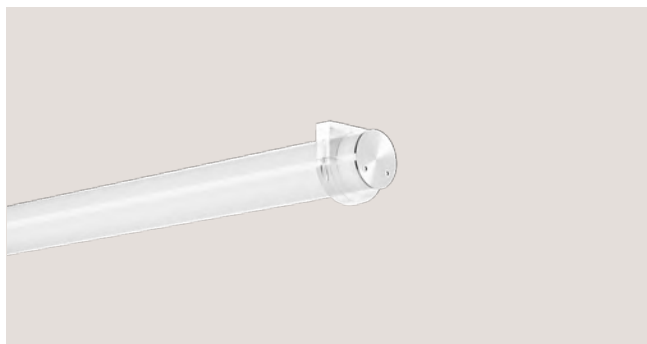

Informação Importante: Driver Remoto Incluído
(não integrado na luminária)

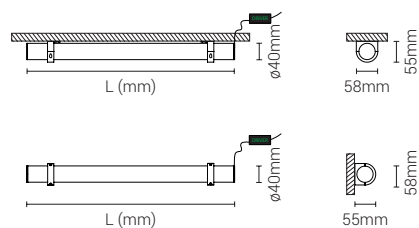





4573 IK04 IP43 Fita LED					
Código	L (mm)	Fluxo/Pot. (aprox. 138lm/W)	HF (€) 4573	1-10V (€) 4673	DALI (€) 4773
4573.055.xFL	550	750 lm	68,80	93,20	143,82
4573.105.xFL	1050	1500 lm	83,05	107,45	158,07
4573.155.xFL	1550	2250 lm	98,01	122,41	173,03
4573.205.xFL	2050	3000 lm	107,66	132,06	182,67
4573.255.xFL	2550	3750 lm	126,33	150,73	201,34
4573.305.xFL	3050	4500 lm	147,07	171,47	222,08

2700K | 3000K | 4000K

4572 IK04 IP43 Fita LED					
Código	L (mm)	Fluxo/Pot. (aprox. 138lm/W)	HF (€) 4572	1-10V (€) 4672	DALI (€) 4772
4572.055.xFL	550	750 lm	63,18	87,58	138,20
4572.105.xFL	1050	1500 lm	77,43	101,83	152,45
4572.155.xFL	1550	2250 lm	92,39	116,79	167,41
4572.205.xFL	2050	3000 lm	113,28	137,68	188,30
4572.255.xFL	2550	3750 lm	134,76	159,16	209,78
4572.305.xFL	3050	4500 lm	155,50	179,90	230,52

2700K | 3000K | 4000K

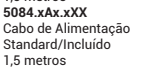
Acessórios			
Standard/Incluído			
 <p>5184.FER.xXX Florão Encastrado Redondo Ø80mm</p>	 <p>4064.MFI.050 Abraçadeira Inox Ø50mm 3,97€</p>	 <p>5184.CDR.xXX Caixa para Driver 16,97€</p>	 <p>5084.COS.xXX Cabos de Suspensão Standard/Incluído 1,5 metros</p>
	 <p>4068.MFI.080 Abraçadeira Inox Ø80mm 4,72€</p>		 <p>5084.xAx.xXX Cabo de Alimentação Standard/Incluído 1,5 metros Outras Medidas na Página 243</p>



1

Branco

código:
4xxx.xxx.1FL

2

Cinza

código:
4xxx.xxx.2FL

4

Escovado

código:
4xxx.xxx.4FL

7

Grafite

código:
4xxx.xxx.7FL

9

Preto

código:
4xxx.xxx.9FL

0

RAL sob Consulta

Outras medidas sob consulta.



4564

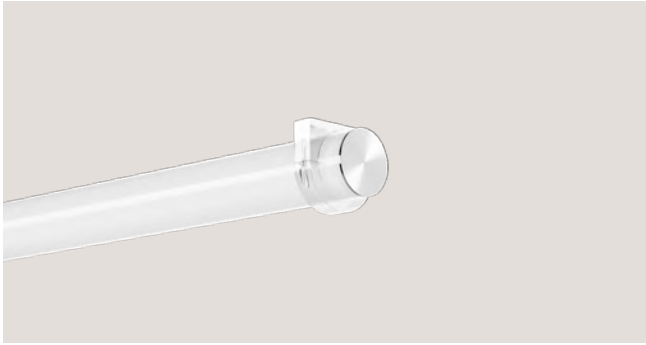

Informação Importante: Driver Remoto Incluído
(não integrado na luminária)

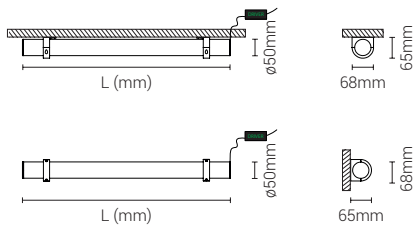

4568

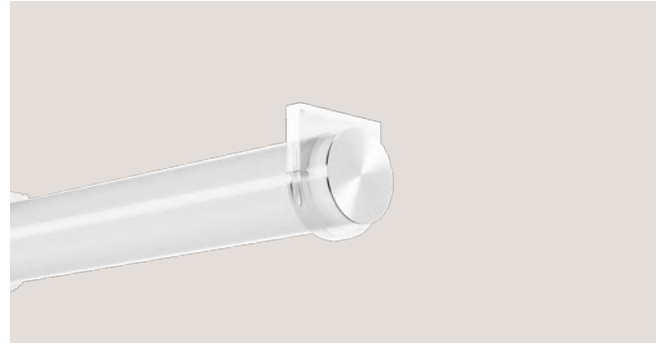

Informação Importante: Driver Remoto Incluído
(não integrado na luminária)

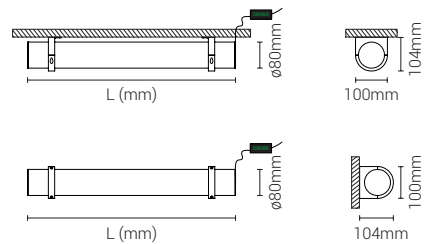

4564 IK07 IP43 Fita LED					
Código	L (mm)	Fluxo/Pot. (aprox. 141lm/W)	HF (€) 4564	1-10V (€) 4664	DALI (€) 4764
4564.055.xFL	550	2000 lm	106,51	123,05	154,61
4564.105.xFL	1050	4000 lm	140,85	157,39	188,95
4564.155.xFL	1550	6000 lm	187,46	196,92	228,48
4564.205.xFL	2050	8000 lm	227,46	236,92	268,48

2700K | 3000K | 4000K

4568 IK07 IP43 Fita LED					
Código	L (mm)	Fluxo/Pot. (aprox. 138lm/W)	HF (€) 4568	1-10V (€) 4668	DALI (€) 4768
4568.055.xFL	550	3000 lm	126,51	143,05	174,61
4568.105.xFL	1050	6000 lm	173,21	182,67	214,23
4568.155.xFL	1550	9000 lm	231,35	241,83	274,91
4568.205.xFL	2050	12000 lm	277,53	288,01	321,08

2700K | 3000K | 4000K



Fosco
código:
4xxx.xxx.xFL





4064

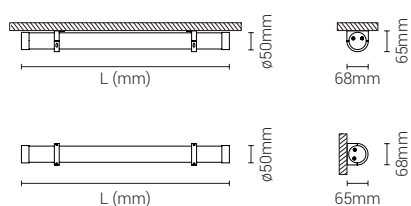
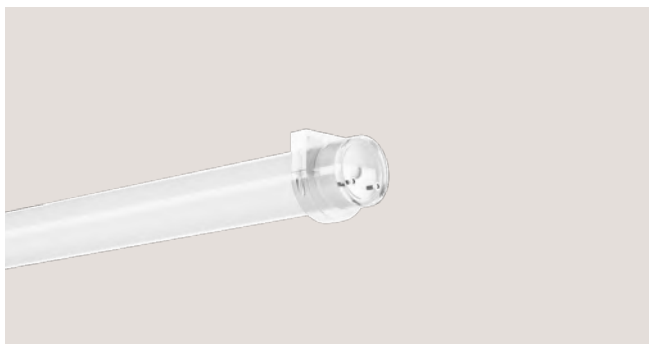

4068

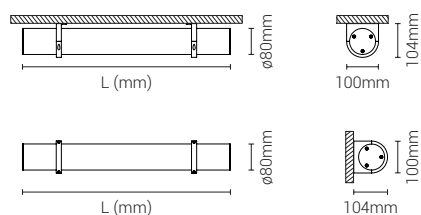

4064 | IK10 | IP65 | Módulo LED

Código	L (mm)	Fluxo/Pot. (aprox. 183lm/W)	HF (€) 4064	1-10V (€) 4164	DALI (€) 4264
4064.035.PxL	355	1300 lm	56,23	-	-
4064.063.PxL	635	2600 lm	66,65	-	-
4064.091.PxL	915	3900 lm	87,87	111,88	110,03
4064.119.PxL	1195	5200 lm	98,66	122,68	120,82
4064.147.PxL	1475	6500 lm	112,48	136,81	134,49
4064.175.PxL	1755	7800 lm	123,46	147,79	145,47
4064.203.PxL	2035	9100 lm	136,64	160,96	158,64
4064.231.PxL	2315	10400 lm	148,27	172,59	170,28
4064.259.PxL	2595	11700 lm	176,32	226,46	210,54
4064.287.PxL	2875	13000 lm	190,70	240,83	224,92

2700K | 3000K | 4000K | 5000K | 6500K

4068 | IK07 | IP65 | Módulo LED

Código	L (mm)	Fluxo/Pot. (aprox. 183lm/W)	HF (€) 4068	1-10V (€) 4168	DALI (€) 4268
4068.037.PxL	376	1300 lm	70,52	-	-
4068.065.PxL	656	2600 lm	83,14	-	-
4068.093.PxL	936	3900 lm	108,50	132,52	130,66
4068.121.PxL	1216	5200 lm	121,95	145,97	144,11
4068.149.PxL	1496	6500 lm	138,42	162,75	160,43
4068.177.PxL	1776	7800 lm	152,86	177,18	174,87
4068.205.PxL	2056	9100 lm	170,54	194,86	192,55
4068.233.PxL	2336	10400 lm	182,01	206,33	204,01
4068.261.PxL	2616	11700 lm	210,78	260,92	245,00
4068.289.PxL	2896	13000 lm	226,76	276,90	260,98

2700K | 3000K | 4000K | 5000K | 6500K

Acessórios

1 2 7 9



4064.MFI.050
Abraçadeira Inox Ø50mm
3,97€

4068.MFI.080
Abraçadeira Inox Ø80mm
4,72€



P

Policarbonato

código:
4x6x.xxx.PxL

1

Branco

código:
4xxx.xxx.1xL

2

Cinza

código:
4xxx.xxx.2xL

4

Escovado

código:
4xxx.xxx.4xL

7

Grafite

código:
4xxx.xxx.7xL

9

Preto

código:
4xxx.xxx.9xL

0

RAL sob Consulta

Outras medidas sob consulta.



4066

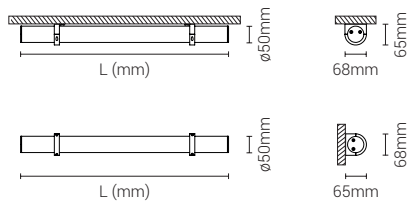
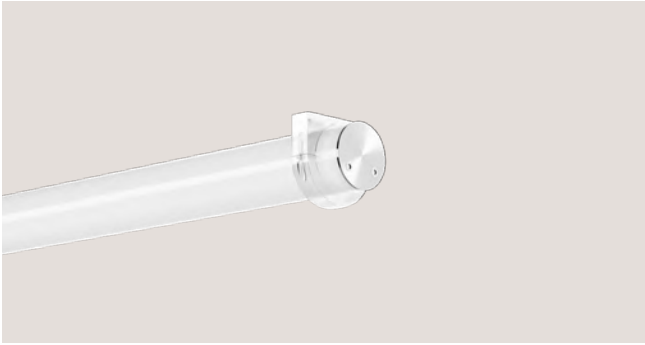

4070

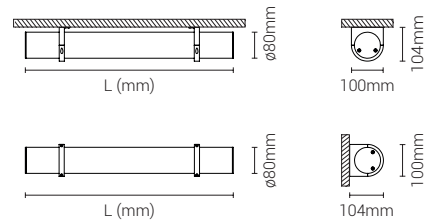
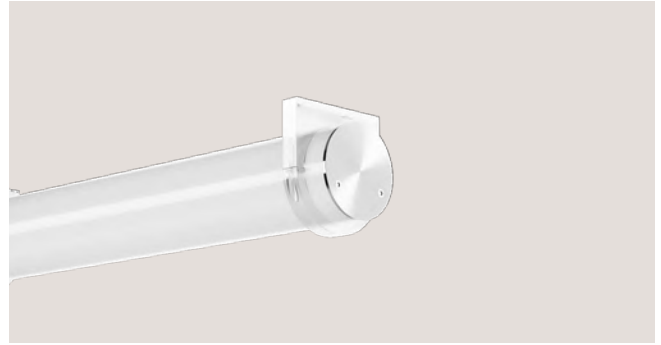

4066 | IK10 | IP43 | Módulo LED

Código	L (mm)	Fluxo/Pot. (aprox.183lm/W)	HF (€) 4066	1-10V (€) 4166	DALI (€) 4266
4066.033.xxL	338	1300 lm	57,25	-	-
4066.061.xxL	618	2600 lm	67,67	-	-
4066.089.xxL	898	3900 lm	88,89	112,90	111,05
4066.117.xxL	1178	5200 lm	99,68	123,70	121,84
4066.145.xxL	1458	6500 lm	113,50	137,83	135,51
4066.173.xxL	1738	7800 lm	124,48	148,81	146,49
4066.201.xxL	2018	9100 lm	137,66	161,98	159,66
4066.229.xxL	2298	10400 lm	149,29	173,61	171,30
4066.257.xxL	2578	11700 lm	177,34	227,48	211,56
4066.285.xxL	2858	13000 lm	191,72	241,85	225,94

2700K | 3000K | 4000K | 5000K | 6500K

4070 | IK07 | IP43 | Módulo LED

Código	L (mm)	Fluxo/Pot. (aprox.183lm/W)	HF (€) 4070	1-10V (€) 4170	DALI (€) 4270
4070.035.xxL	354	1300 lm	79,36	-	-
4070.063.xxL	634	2600 lm	91,98	-	-
4070.091.xxL	914	3900 lm	117,34	141,36	139,50
4070.119.xxL	1194	5200 lm	130,79	154,81	152,95
4070.147.xxL	1474	6500 lm	147,26	171,59	169,27
4070.175.xxL	1754	7800 lm	161,70	186,02	183,71
4070.203.xxL	2034	9100 lm	179,38	203,70	201,39
4070.231.xxL	2314	10400 lm	190,85	215,17	212,85
4070.259.xxL	2594	11700 lm	219,62	269,76	253,84
4070.287.xxL	2874	13000 lm	235,60	285,74	269,82

2700K | 3000K | 4000K | 5000K | 6500K



Fosco
código: 4xxx.xxx.xFL

Transparente
código: 4xxx.xxx.xTL



81,29€ 104,78€

Estas luminárias podem incluir estes componentes elétricos a partir de 1130mm.





Estanque e Industrial

▶ **Luminária estanque, projeção de luz descendente**



4018

Pag. 78



4018 LED

Pag. 78

▶ **Luminária industrial, projeção de luz descendente**



5501

Pag. 80



5502

Pag. 80



5601

Pag. 80



5001

Pag. 81



5002

Pag. 81



5006

Pag. 81



4018

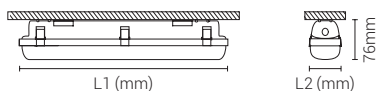
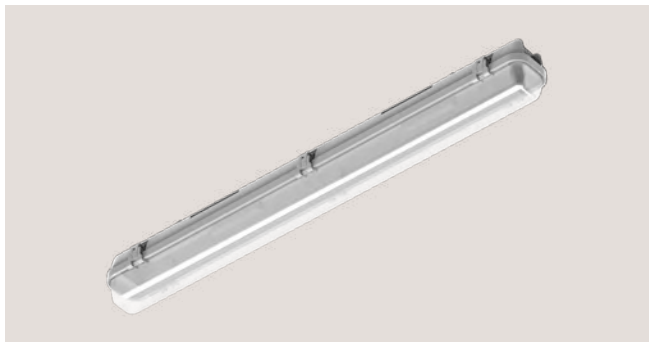

4018 LED

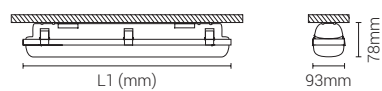

4018 IK08 IP66 T5 T8 LED						
Código	L1 (mm)	L2 (mm)	Pot.	HF (€) 4018	1-10V (€) 4118	DALI (€) 4218
4018.114.2PL	665	64	T5 14W	34,25	62,84	70,87
4018.124.2PL	665	64	T5 24W	34,25	62,84	70,87
4018.128.2PL	1263	64	T5 28W	37,80	66,39	74,43
4018.154.2PL	1263	64	T5 54W	37,80	66,39	74,43
4018.135.2PL	1562	64	T5 35W	41,05	69,64	79,99
4018.149.2PL	1562	64	T5 49W	41,05	69,64	79,99
4018.180.2PL	1562	64	T5 80W	42,59	75,51	81,54
4018.214.2PL	665	94	T5 (2x) 14W	43,33	76,25	82,13
4018.224.2PL	665	94	T5 (2x) 24W	43,33	76,25	82,13
4018.228.2PL	1263	94	T5 (2x) 28W	47,66	80,58	86,45
4018.254.2PL	1263	94	T5 (2x) 54W	47,66	80,58	86,45
4018.235.2PL	1562	94	T5 (2x) 35W	52,30	85,22	91,09
4018.249.2PL	1562	94	T5 (2x) 49W	52,30	85,22	91,09
4018.280.2PL	1562	94	T5 (2x) 80W	64,51	117,52	115,51
4018.106.2PL	665	63	T8 LED 8W	26,30	-	-
4018.112.2PL	1263	63	T8 LED 12W	46,58	-	-
4018.115.2PL	1562	63	T8 LED 18W	57,55	-	-
4018.206.2PL	665	94	T8 LED (2x) 8W	37,09	-	-
4018.212.2PL	1263	94	T8 LED (2x) 12W	74,86	-	-
4018.215.2PL	1562	94	T8 LED (2x) 18W	94,95	-	-
4018.106.2PX	665	64	-	17,06	-	-
4018.112.2PX	1263	64	-	20,31	-	-
4018.115.2PX	1562	64	-	23,55	-	-
4018.206.2PX	665	94	-	18,61	-	-
4018.212.2PX	1263	94	-	22,32	-	-
4018.215.2PX	1562	94	-	26,95	-	-

2700K | 3000K | 4000K | 5000K | 6500K

4018 IK08 IP66 Módulo LED					
Código	L1 (mm)	Fluxo/Pot. (aprox.183lm/W)	HF (€) 4018	1-10V (€) 4118	DALI (€) 4218
4018.060.2OL	600	2200 lm	55,50	93,84	85,03
4018.119.2OL	1198	4400 lm	74,50	118,69	109,88
4018.149.2OL	1500	5500 lm	86,50	130,53	121,72
4018.260.2OL	600	4400 lm	72,63	110,80	101,99
4018.211.2OL	1198	8800 lm	112,90	151,07	142,26
4018.214.2OL	1500	11000 lm	137,76	175,93	199,12

2700K | 3000K | 4000K | 5000K | 6500K



2

Cinza

código:
4018.xxx.2xx



Prismático

código:
4018.xxx.xPx



Opalino

código:
4018.xxx.xOx





5501



5501 IK08 IP65 Módulo LED		
Código	Fluxo/Pot. (aprox.)	€
5501.087.2TL	87W - 13950 lm	199,99
5501.113.2TL	113W - 17400 lm	199,99
5501.135.2TL	135W - 19600 lm	199,99

3000K | 4000K

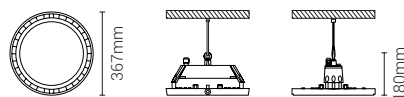

Cabos de suspensão não incluídos.

5502



5502 IK08 IP65 Módulo LED		
Código	Fluxo/Pot. (aprox.)	€
5502.144.2TL	144W - 22500 lm	310,69
5502.185.2TL	185W - 28000 lm	310,69
5502.215.2TL	215W - 31000 lm	310,69

3000K | 4000K

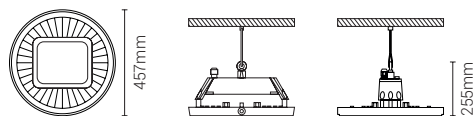

Cabos de suspensão não incluídos.

5601



5601 IK08 IP65 Módulo LED		
Código	Fluxo/Pot. (aprox.)	€
5601.087.2TL	87W - 13950 lm	252,26
5601.113.2TL	113W - 17400 lm	252,26
5601.135.2TL	135W - 19600 lm	252,26

3000K | 4000K

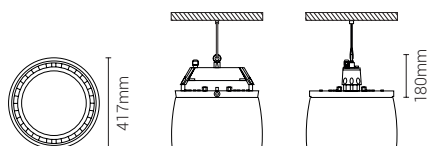

Cabos de suspensão não incluídos.

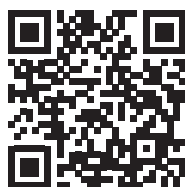

1

Branco

código:
5x0x.xxx.1xL

2

Cinza

código:
5x0x.xxx.2xL

7

Grafite

código:
5x0x.xxx.7xL

9

Preto

código:
5x0x.xxx.9xL



5001



5001 | IK10 | IP20 | E27

Código	Fluxo/Pot. (aprox.)	€
5001.100.xPX	E27	119,06

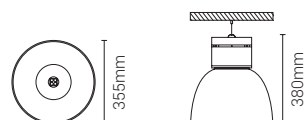

Cabos de suspensão não incluídos.

5002



5002 | IK10 | IP20 | E27

Código	Fluxo/Pot. (aprox.)	€
5002.100.xPX	E27	139,34
9202.000.XXX	Tampa - Prismático	30,91

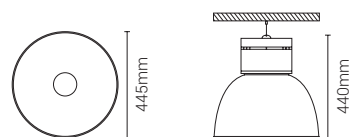

Cabos de suspensão não incluídos.

5006



5006 | IK10 | IP20 | E27

Código	Fluxo/Pot. (aprox.)	€
5006.100.xxX	E27	126,57
9202.GRE.xXX	Grelha	20,69
9202.VID.xTX	Vidro	27,73

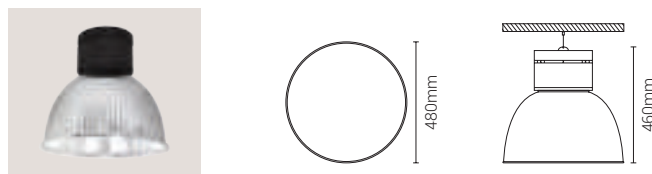
Refletor em alumínio liso ou multifacetado como opção.
Cabos de suspensão não incluídos.

Transparente

código:
5x0x.xxx.xTL

Prismático

código:
5x0x.xxx.xPX

Alumínio

código:
5006.xxx.xAX

Multifacetado

código:
5006.xxx.xMX





Circulares

Luminária de encastrar com aba



5511 Pg. 86

Luminária de encastrar sem aba



5510 Pg. 86

Luminária saliente



5010 Pg. 87



5011 Pg. 87

Luminária suspensa



5015 Pg. 88



5016 Pg. 88

Donuts

Luminária de encastrar com aba



5512 Pg. 89



5513 Pg. 89

Luminária saliente



5004 Pg. 90



5530 Pg. 90

Luminária suspensa



5007 Pg. 91



5531 Pg. 91

Luminária suspensa, projeção de luz descendente e ascendente



5541 Pg. 91

Slim Donuts

Luminária saliente



5514 Pg. 92

Luminária saliente, projeção de luz interior



5504 Pg. 92

Luminária saliente, projeção de luz exterior



5544 Pg. 92

▶ **Luminária suspensa**



5517 Pg. 94

▶ **Luminária saliente, projeção de luz interior**



5507 Pg. 94

▶ **Luminária saliente, projeção de luz exterior**



5547 Pg. 94

▶ **Luminária suspensa vertical, projeção de luz interior**



5536 Pg. 96

▶ **Luminária suspensa vertical, projeção de luz exterior**



5537 Pg. 96

Lineares

▶ **Luminária de encastrar com aba**



5520 Pg. 97



5521 Pg. 97

▶ **Luminária saliente**



5024 Pg. 98



5025 Pg. 98

▶ **Luminária suspensa**



5026 Pg. 99



5027 Pg. 99

▶ **Luminária saliente**



5524 Pg. 100



5525 Pg. 100



5528 Pg. 100

▶ **Luminária suspensa**



5526 Pg. 101



5527 Pg. 101

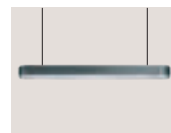

5529 Pg. 101

▶ **Luminária de encastrar com aba**



7038 Pg. 102



7039 Pg. 102

▶ **Luminária saliente**



7048 Pg. 103



7049 Pg. 103

▶ **Painel de luz de encastrar em tetos suspensos**



5550 Pg. 104

▶ **Painel de luz saliente para tetos suspensos**



5551 Pg. 104

▶ **Painel de luz suspenso para tetos suspensos**



5552 Pg. 104



5511

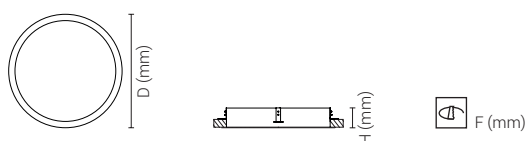

5510

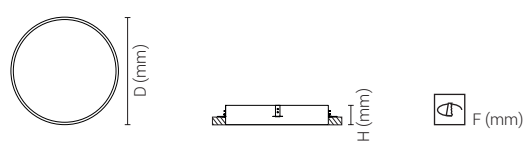
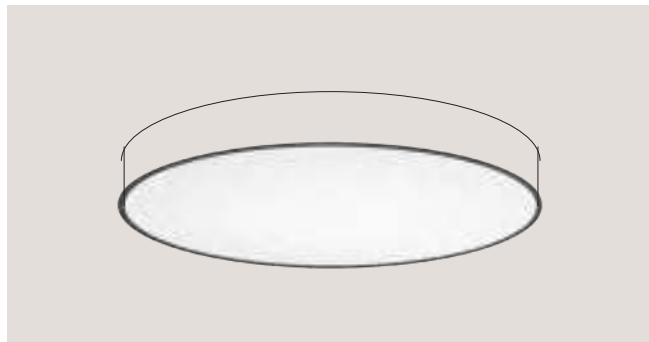

5511 IK03 IP20 Módulo LED							
Código	D (mm)	H (mm)	F (mm)	Fluxo/Pot. (aprox.)	HF (€) 5511	1-10V (€) 5611	DALI (€) 5711
5511.114.xOL	250	80	255	14W - 2000 lm	127,05	164,88	164,88
5511.250.xOL	250	80	255	25W - 3000 lm	127,05	164,88	164,88
5511.118.xOL	350	80	355	15W - 2000 lm	170,25	209,62	209,62
5511.129.xOL	350	80	355	29W - 4000 lm	170,25	209,62	209,62
5511.116.xOL	450	120	455	25W - 3500 lm	223,69	251,64	251,64
5511.125.xOL	450	120	455	35W - 4700 lm	223,69	251,64	251,64
5511.110.xOL	650	120	655	45W - 7500 lm	330,55	350,02	350,02
5511.516.xOL	650	120	655	80W - 14000 lm	330,55	350,02	350,02
5511.205.xOL	950	120	955	98W - 16000 lm	522,82	555,05	555,05
5511.816.xOL	950	120	955	140W - 25000 lm	522,82	555,05	555,05
5511.011.xOL	1250	120	1255	110W - 16000 lm	939,21	1005,20	997,44
5511.210.xOL	1250	120	1255	210W - 33000 lm	939,21	1005,20	997,44

2700K | 3000K | 4000K | 5000K | 6500K

5510 IK03 IP20 Módulo LED							
Código	D (mm)	H (mm)	F (mm)	Fluxo/Pot. (aprox.)	HF (€) 5510	1-10V (€) 5610	DALI (€) 5710
5510.114.xOL	250	80	250	14W - 2000 lm	125,87	165,24	165,24
5510.250.xOL	250	80	250	25W - 3000 lm	125,87	165,24	165,24
5510.118.xOL	350	80	350	15W - 2000 lm	168,71	208,08	208,08
5510.129.xOL	350	80	350	29W - 4000 lm	168,71	208,08	208,08
5510.116.xOL	450	120	450	25W - 3500 lm	225,82	253,77	253,77
5510.125.xOL	450	120	450	35W - 4700 lm	225,82	253,77	253,77
5510.110.xOL	650	120	650	45W - 7500 lm	333,43	352,90	352,90
5510.516.xOL	650	120	650	80W - 14000 lm	333,43	352,90	352,90
5510.205.xOL	950	120	950	98W - 16000 lm	526,84	563,07	559,08
5510.816.xOL	950	120	950	140W - 25000 lm	526,84	563,07	559,08
5510.011.xOL	1250	120	1250	110W - 16000 lm	944,24	1010,23	1002,46
5510.210.xOL	1250	120	1250	210W - 33000 lm	944,24	1010,23	1002,46

2700K | 3000K | 4000K | 5000K | 6500K



1

Branco

código:
5x1x.xxx.10L

2

Cinza

código:
5x1x.xxx.20L

7

Grafite

código:
5x1x.xxx.70L

9

Preto

código:
5x1x.xxx.90L

0

RAL sob consulta



5010

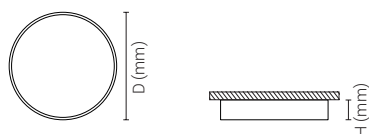

5011

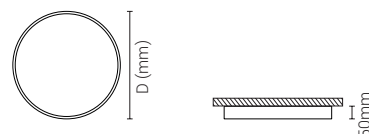

5010 | IK03 | IP20 | Módulo LED



Código	D (mm)	H (mm)	Fluxo/Pot. (aprox.)	HF (€)		
				5010	1-10V (€) 5110	DALI (€) 5210
5010.114.xOL	250	80	14W - 2000 lm	113,86	140,14	140,14
5010.250.xOL	250	80	25W - 3000 lm	113,86	140,14	140,14
5010.118.xOL	350	80	15W - 2000 lm	157,39	185,40	185,40
5010.129.xOL	350	80	29W - 4000 lm	157,39	185,40	185,40
5010.116.xOL	450	120	25W - 3500 lm	220,44	243,33	243,33
5010.125.xOL	450	120	35W - 4700 lm	220,44	243,33	243,33
5010.110.xOL	650	120	45W - 7500 lm	320,99	340,56	338,56
5010.516.xOL	650	120	80W - 14000 lm	320,99	340,56	338,56
5010.205.xOL	950	120	98W - 16000 lm	508,81	545,24	541,24
5010.816.xOL	950	120	140W - 25000 lm	508,81	545,24	541,24
5010.011.xOL	1250	120	110W - 16000 lm	935,30	1001,57	993,81
5010.210.xOL	1250	120	210W - 33000 lm	935,30	1001,57	993,81

2700K | 3000K | 4000K | 5000K | 6500K

5011 | IK03 | IP40 | Módulo LED

Código	D (mm)	Fluxo/Pot. (aprox.)	€
5011.030.xOL	300	21W - 2500 lm	140,02
5011.040.xOL	400	27W - 3300 lm	229,13
5011.050.xOL	500	30W - 4000 lm	256,51

3000K | 4000K



Opalino
código:
5x1x.xxx.xOL

KIT EMG

1 H

81,29€

KIT EMG

3 H

104,78€

Estas luminárias podem incluir estes componentes elétricos.





5015

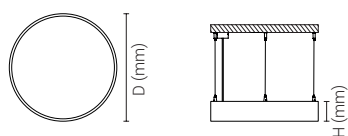

5016

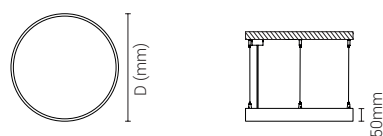

5015 IK03 IP20 Módulo LED						
Código	D (mm)	H (mm)	Fluxo/Pot. (aprox.)	HF (€)		DALI (€)
				5015	5115	5215
5015.114.xOL	250	80	14W - 2000 lm	147,70	173,98	173,98
5015.250.xOL	250	80	25W - 3000 lm	147,70	173,98	173,98
5015.118.xOL	350	80	15W - 2000 lm	191,23	219,24	219,24
5015.129.xOL	350	80	29W - 4000 lm	191,23	219,24	219,24
5015.116.xOL	450	120	25W - 3500 lm	254,29	277,17	277,17
5015.125.xOL	450	120	35W - 4700 lm	254,29	277,17	277,17
5015.110.xOL	650	120	45W - 7500 lm	354,83	374,40	372,40
5015.516.xOL	650	120	80W - 14000 lm	354,83	374,40	372,40
5015.205.xOL	950	120	98W - 16000 lm	542,65	579,08	575,08
5015.816.xOL	950	120	140W - 25000 lm	542,65	579,08	575,08
5015.011.xOL	1250	120	110W - 16000 lm	973,67	1039,95	1032,18
5015.210.xOL	1250	120	210W - 33000 lm	973,67	1039,95	1032,18

2700K | 3000K | 4000K | 5000K | 6500K

5016 IK03 IP40 Módulo LED			
Código	D (mm)	Fluxo/Pot. (aprox.)	€
5016.030.xOL	300	21W - 2500 lm	166,79
5016.040.xOL	400	27W - 3300 lm	257,31
5016.050.xOL	500	30W - 4000 lm	306,07

3000K | 4000K

Acessórios

1 2 7 9

Standard/Incluído

5084.FSR.xXX
Florão Saliente
Redondo Ø58mm

Opção

5084.FER.xXX
Florão Encastrado
Redondo Ø55mm
8,77€

Opção

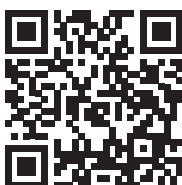
5084.CSx.xXX
Florão Saliente
Redondo
Ø118mm
3 ou 4 furos
18,61€5084.COS.xXX
Cabos de Suspensão
Standard/Incluído 1,5 metros
5084.xAx.xXX
Cabo de Alimentação
Standard/Incluído 1,5 metros
Outras Medidas na Página 243

1

Branco

código:
5x1x.xxx.10L

2

Cinza

código:
5x1x.xxx.20L

7

Grafite

código:
5x1x.xxx.70L

9

Preto

código:
5x1x.xxx.90L

0

RAL sob consulta



5512

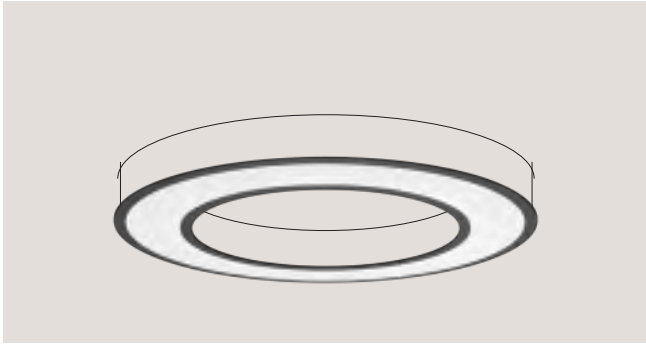

5513

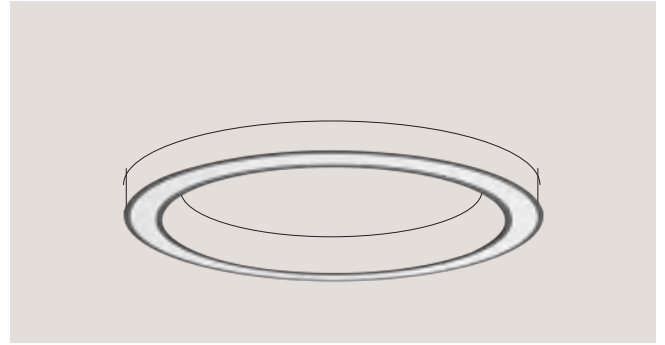

Informação Importante: Driver Remoto Incluído
(não integrado na luminária)

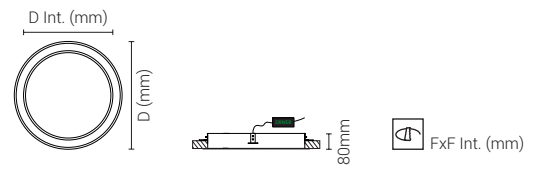
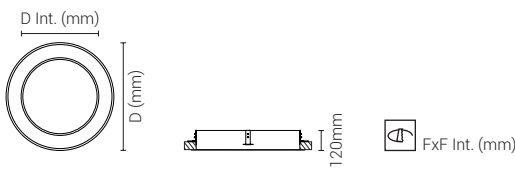

5512 IK03 IP20 Módulo LED								
Código	D (mm)	D Int. (mm)	F (mm)	F Int. (mm)	Fluxo/Pot. (aprox. 183lm/W)	HF (€) 5512	1-10V (€) 5612	DALI (€) 5712
5512.065.xOL	670	650	655	445	7963 lm	349,89	369,46	369,46
5512.095.xOL	970	950	955	645	11944 lm	490,03	537,41	537,41
5512.125.xOL	1270	1250	1255	945	17894 lm	653,92	697,97	697,97
5512.150.xOL	1570	1550	1575	1245	22369 lm	866,13	917,93	917,93

2700K | 3000K | 4000K | 5000K | 6500K

5513 IK03 IP20 Módulo LED								
Código	D (mm)	D Int. (mm)	F (mm)	F Int. (mm)	Fluxo/Pot. (aprox. 183lm/W)	HF (€) 5513	1-10V (€) 5613	DALI (€) 5713
5513.065.xOL	670	650	655	445	8882 lm	316,24	335,81	335,81
5513.095.xOL	970	950	955	645	12608 lm	461,42	508,88	508,88
5513.125.xOL	1270	1250	1255	945	17252 lm	652,45	704,29	704,29
5513.150.xOL	1570	1550	1575	1245	18024 lm	851,20	861,84	903,01

2700K | 3000K | 4000K | 5000K | 6500K

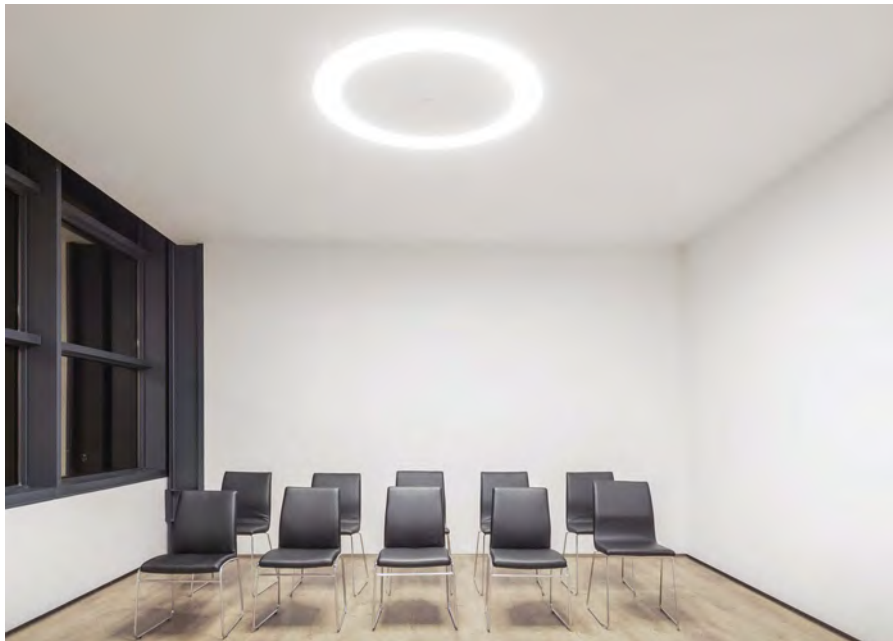

Opalino
código:
5x1x.xxx.xOL

KIT EMG
1H

81,29€

KIT EMG
3H

104,78€

Estas luminárias podem incluir estes componentes elétricos.





5004



5004 | IK04 | IP20 | Módulo LED

Código	D (mm)	D Int. (mm)	Fluxo/Pot. (aprox. 183lm/W)	HF (€) 5004	1-10V (€) 5104	DALI (€) 5204
5004.065.xOL	650	450	7963 lm	326,72	346,29	346,29
5004.095.xOL	950	650	11944 lm	457,43	504,82	504,82
5004.125.xOL	1250	950	17894 lm	617,30	664,69	664,69
5004.150.xOL	1500	1200	22369 lm	820,24	872,05	872,05

2700K | 3000K | 4000K | 5000K | 6500K

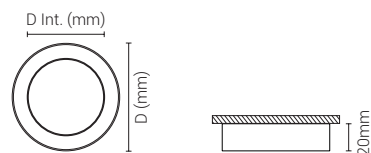

5530



5530 | IK03 | IP20 | Módulo LED

Código	D (mm)	D Int. (mm)	Fluxo/Pot. (aprox. 183lm/W)	HF (€) 5530	1-10V (€) 5630	DALI (€) 5730
5530.065.xOL	650	490	8882 lm	293,89	313,46	313,46
5530.095.xOL	950	790	12608 lm	430,53	474,81	474,81
5530.125.xOL	1250	1090	17252 lm	617,04	666,88	666,88
5530.150.xOL	1500	1340	18024 lm	808,40	860,20	860,20

2700K | 3000K | 4000K

Informação Importante: Driver Remoto Incluído (não integrado na luminária)

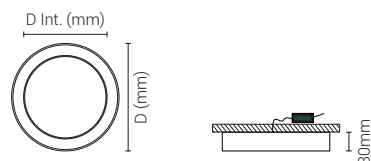

Acessórios

1 2 7 9

Standard/Incluído

5084.FSR.xXX
Florão Saliente
Redondo Ø58mmStandard/Incluído
Opção5084.FER.xXX
Florão Encastrado
Redondo Ø55mm
8,77€

Opção

5084.CSx.xXX
Florão Saliente/
Caixa Driver
Redondo Ø118mm
3 ou 4 furos
18,61€

Opção

5184.CSx.xXX
Florão Saliente/
Caixa Driver
Redondo Ø360mm
3 ou 4 furos
49,56€5084.COS.xXX
Cabos de Suspensão
Standard/Incluído 1,5 metros
5084.xAx.xXX
Cabo de Alimentação
Standard/Incluído 1,5 metros
Outras Medidas na Página 243

Quando o driver é incorporado o florão standard incluído é o 5084.FSR.xXX.

Quando o driver é remoto o florão standard incluído é o 5084.FER.xXX.



1

Branco

código:
5xxx.xxx.10L

2

Cinza

código:
5xxx.xxx.20L

7

Grafite

código:
5xxx.xxx.70L

9

Preto

código:
5xxx.xxx.90L

0

RAL sob consulta



5007



5007 IK04 IP20 Módulo LED						
Código	D (mm)	D Int. (mm)	Fluxo/Pot. (aprox. 183lm/W)	HF (€) 5007	1-10V (€) 5107	DALI (€) 5207
5007.065.xOL	650	450	7963 lm	360,56	380,13	380,13
5007.095.xOL	950	650	11944 lm	491,27	538,66	538,66
5007.125.xOL	1250	950	17894 lm	656,77	704,16	704,16
5007.150.xOL	1500	1200	22369 lm	859,71	911,52	911,52

2700K | 3000K | 4000K | 5000K | 6500K

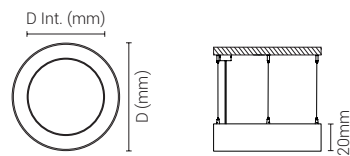

5531



5531 IK03 IP20 Módulo LED						
Código	D (mm)	D Int. (mm)	Fluxo/Pot. (aprox. 183lm/W)	HF (€) 5531	1-10V (€) 5631	DALI (€) 5731
5531.065.xOL	650	490	8882 lm	347,50	369,79	369,79
5531.095.xOL	950	790	12608 lm	493,89	531,10	531,10
5531.125.xOL	1250	1090	17252 lm	648,75	685,93	685,93
5531.150.xOL	1500	1340	18024 lm	838,15	879,22	879,22

2700K | 3000K | 4000K

Informação Importante: Driver Remoto Incluído
(não integrado na luminária)

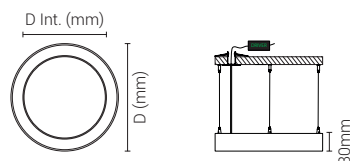

5541



5541 IK04 IP20 Módulo LED						
Código	D (mm)	D Int. (mm)	Fluxo/Pot. (aprox. 183lm/W)	HF (€) 5541	1-10V (€) 5641	DALI (€) 5741
5541.065.xOL	650	490	11612 lm	433,87	456,16	456,16
5541.095.xOL	950	790	20808 lm	615,88	653,09	653,09
5541.125.xOL	1250	1090	28152 lm	827,13	864,31	864,31
5541.150.xOL	1500	1340	28924 lm	1099,91	1140,98	1140,98

2700K | 3000K | 4000K

Informação Importante: Driver Remoto Incluído
(não integrado na luminária)

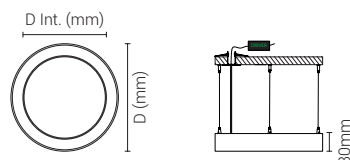

Opalino

código:
5xxx.xxx.xOL

81,29€



104,78€

Estas luminárias podem incluir
estes componentes elétricos.





Luminária saliente



1

Branco

código:
5xx4.xxx.10L

2

Cinza

código:
5xx4.xxx.20L

7

Grafite

código:
5xx4.xxx.70L

9

Preto

código:
5xx4.xxx.90L

0

RAL sob consulta

5514

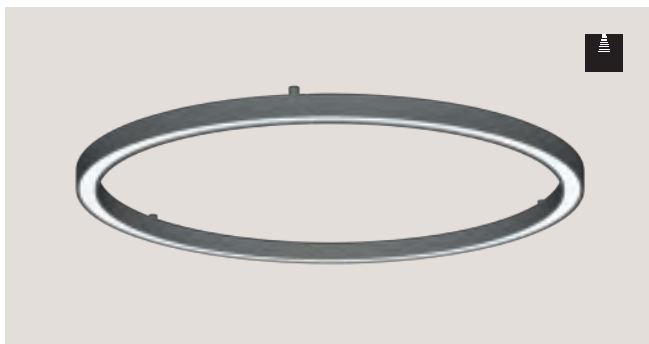

5514 IK03 IP20 Módulo LED							
Código	D (mm)	D Int. (mm)	H (mm)	Fluxo/Pot. (aprox. 184lm/W)	HF (€)	1-10V (€)	DALI (€)
					5514	5614	5714
5514.065.xOL	670	610	30	6700 lm	261,95	281,52	281,52
5514.095.xOL	950	890	30	9600 lm	348,77	409,06	409,06
5514.125.xOL	1250	1190	30	13000 lm	491,63	528,05	528,05
5514.150.xOL	1500	1440	30	15400 lm	623,23	659,65	659,65

2700K | 3000K | 4000K

5504



5504 IK05 IP20 Fita LED						
Código	D (mm)	D Int. (mm)	H (mm)	Fluxo/Pot. (aprox. 138lm/W)	HF (€)	DALI (€)
					5504	5704
5504.035.xOL	356	306	25	1500 lm	132,32	177,64
5504.045.xOL	452	402	25	2100 lm	144,23	190,41
5504.065.xOL	643	593	25	3000 lm	167,63	213,81
5504.095.xOL	961	911	25	4500 lm	206,80	248,60
5504.125.xOL	1247	1197	25	6000 lm	251,74	306,95
5504.150.xOL	1502	1452	25	7050 lm	291,04	346,25
5504.200.xOL	2011	1961	25	9450 lm	455,53	510,51
5504.250.xOL	2489	2439	25	12000 lm	624,31	679,29

2700K | 3000K | 4000K
1-10V sob consulta.

5544

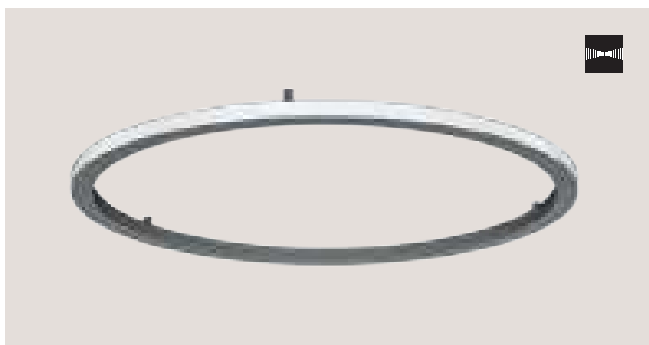

5544 IK05 IP20 Fita LED						
Código	D (mm)	D Int. (mm)	H (mm)	Fluxo/Pot. (aprox. 138lm/W)	HF (€)	DALI (€)
					5544	5744
5544.035.xOL	366	316	25	1500 lm	132,32	177,64
5544.045.xOL	462	412	25	2100 lm	144,23	190,41
5544.065.xOL	653	603	25	3000 lm	167,63	213,81
5544.095.xOL	971	921	25	4500 lm	206,80	248,60
5544.125.xOL	1258	1208	25	6000 lm	251,74	306,95
5544.150.xOL	1512	1462	25	7050 lm	291,04	346,25
5544.200.xOL	2022	1972	25	9450 lm	455,53	510,51
5544.250.xOL	2499	2449	25	12000 lm	624,31	679,29

2700K | 3000K | 4000K
1-10V sob consulta.

Informação Importante: Driver Remoto Incluído
(não integrado na luminária)

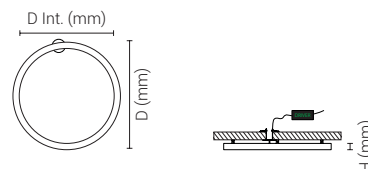

Opalino
código:
5xx4.xxx.xOL

KIT EMG 1H	KIT EMG 3H
81,29€	104,78€

Estas luminárias podem incluir estes componentes elétricos.





5517



5507



5547



Informação Importante: Driver Remoto Incluído
(não integrado na luminária)

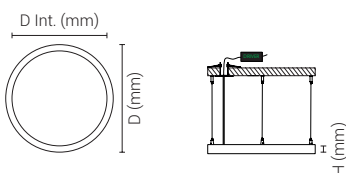

5517 IK03 IP20 Módulo LED							
Código	D (mm)	D Int. (mm)	H (mm)	Fluxo/Pot. (aprox. 184lm/W)	HF (€) 5517	1-10V (€) 5617	DALI (€) 5717
5517.065.xOL	670	610	30	6700 lm	294,32	316,57	316,57
5517.095.xOL	950	890	30	9600 lm	381,11	444,14	444,14
5517.125.xOL	1250	1190	30	13000 lm	519,87	559,01	559,01
5517.150.xOL	1500	1440	30	15400 lm	655,46	694,60	694,60

2700K | 3000K | 4000K

5507 IK05 IP20 Fita LED							
Código	D (mm)	D Int. (mm)	H (mm)	Fluxo/Pot. (aprox. 138lm/W)	HF (€) 5507	DALI (€) 5707	
5507.035.xOL	356	306	25	1500 lm	155,01	212,27	
5507.045.xOL	452	402	25	2100 lm	176,89	225,03	
5507.065.xOL	643	593	25	3000 lm	200,29	248,43	
5507.095.xOL	961	911	25	4500 lm	239,47	283,22	
5507.125.xOL	1247	1197	25	6000 lm	284,40	341,57	
5507.150.xOL	1502	1452	25	7050 lm	323,61	380,78	
5507.200.xOL	2011	1961	25	9450 lm	488,09	545,04	
5507.250.xOL	2489	2439	25	12000 lm	656,87	711,85	









2700K | 3000K | 4000K

1-10V sob consulta.

5547 IK05 IP20 Fita LED							
Código	D (mm)	D Int. (mm)	H (mm)	Fluxo/Pot. (aprox. 138lm/W)	HF (€) 5547	DALI (€) 5747	
5547.035.xOL	366	316	25	1500 lm	155,01	212,27	
5547.045.xOL	462	412	25	2100 lm	176,89	225,03	
5547.065.xOL	653	603	25	3000 lm	200,29	248,43	
5547.095.xOL	971	921	25	4500 lm	239,47	283,22	
5547.125.xOL	1258	1208	25	6000 lm	284,40	341,57	
5547.150.xOL	1512	1462	25	7050 lm	323,61	380,78	
5547.200.xOL	2022	1972	25	9450 lm	488,09	545,04	
5547.250.xOL	2499	2449	25	12000 lm	656,87	711,85	

2700K | 3000K | 4000K

1-10V sob consulta.

Acessórios			
Standard/Incluído	Opção		
 5084.FER.xXX 5184.FER.xXX Florão Encastrado Redondo 5517: Ø55mm 5507 5547: Ø80mm		 5184.CSx.xXX Florão Saliente/Caixa Driver Redondo Ø360mm 3 ou 4 furos 49,56€	
Opção			
 5084.CSx.xXX Florão Saliente Redondo Ø118mm 3 ou 4 furos 18,61€		 5084.COS.xXX Cabos de Suspensão Standard/Incluído 1,5m 5084.xAx.xXX Cabo de Alimentação Standard/Incluído 1,5m Outras Medidas na Página 243	



1

Branco

código:
5xx7.xxx.10L

2

Cinza

código:
5xx7.xxx.20L

7

Grafite

código:
5xx7.xxx.70L

9

Preto

código:
5xx7.xxx.90L

0

RAL sob consulta

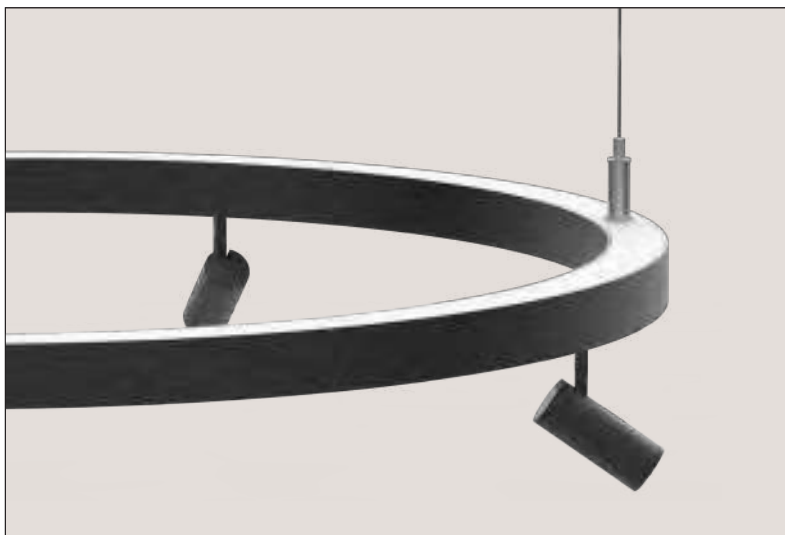

Acessórios			
Código	Cor Acabamento	Fluxo/Pot. (aprox.)	€
5517.N38.xTL	Cor	3.5W - 500 lm	69,75
5517.P13.xTL	Cor	3.5W - 500 lm	69,75
5517.P33.xTL	Cor	3.5W - 500 lm	77,75
5517.P43.xTL	Cor	3.5W - 500 lm	85,75
5507.N26.xTL	Cor	1W - 140 lm	59,75
5507.P12.xTL	Cor	1W - 140 lm	59,75
5507.P32.xTL	Cor	1W - 140 lm	66,75
5507.P42.xTL	Cor	1W - 140 lm	73,75

Possibilidade de conjugação de nanos e suspensões.
Os nanos podem ser aplicados na superfície superior ou inferior (nunca simultaneamente). As suspensões apenas podem ser aplicadas na superfície inferior do donut.

Na referência 5517, se pretender acrescentar nanos na superfície inferior do donut, o difusor passa para a superfície superior conforme se pode observar na imagem à esquerda.

Para a referência 5517 o mínimo de acessórios a aplicar é de 3 unidades e o máximo é de 18.

Para as referências 5507 e 5547, o máximo de acessórios a aplicar é 8 para o diâmetro de 650mm, 12 para o de 950mm, 16 para o de 1250mm e 20 para o de 1500mm.

O cliente deverá identificar devidamente a distribuição desejada dos acessórios aquando da encomenda.

5517

Exemplo de Conjugações

5517.095.10L + (4x 5517.P43.9TL)

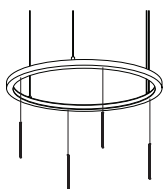

5517.095.10L + (4x 5517.N38.9TL)

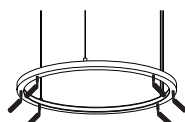

5517.095.10L + (8x 5517.N38.9TL)

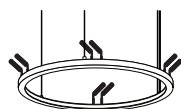

Pendentes

5517.N38.xTL



5517.P13.xTL



5517.P33.xTL

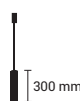

5517.P43.xTL

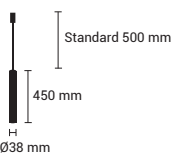

5507 | 5547

Exemplo de Conjugações

5507.095.10L + (7x 5507.P42.9TL)

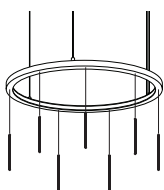

5507.095.10L + (4x 5507.N25.9TL)

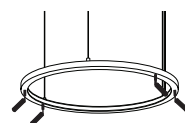

5507.095.10L + (4x 5507.N25.9TL)

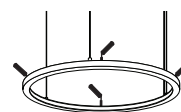

5547.095.10L + (6x 5507.P42.9TL)

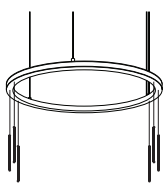

5547.095.10L + (6x 5507.N25.9TL)

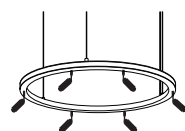

5547.095.10L + (6x 5507.N25.9TL)

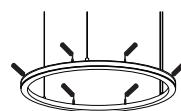

Nanos

5507.N25.xTL



Pendentes

5507.P12.xTL



5507.P32.xTL

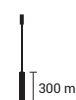

5507.P42.xTL

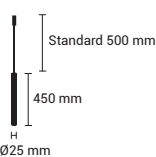

Opalino

código:
5xx7.xxx.x0L





5536



Informação Importante: Driver Remoto Incluído
(não integrado na luminária)

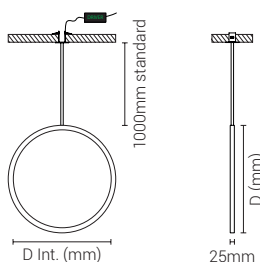

5537



Informação Importante: Driver Remoto Incluído
(não integrado na luminária)

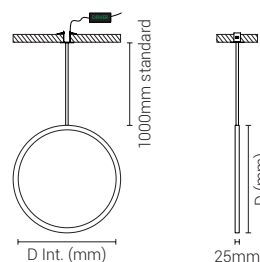

5536 IK05 IP20 Fita LED					
Código	D (mm)	D Int. (mm)	Fluxo/Pot. (aprox. 138lm/W)	HF (€) 5536	DALI (€) 5736
5536.045.xOL	450	400	2100 lm	149,60	195,77
5536.065.xOL	650	600	3000 lm	173,00	219,17
5536.095.xOL	950	900	4500 lm	212,17	253,96
5536.125.xOL	1250	1200	6000 lm	257,11	312,32

2700K | 3000K | 4000K | 5000K | 6500K

1-10V sob consulta.

5537 IK05 IP20 Fita LED					
Código	D (mm)	D Int. (mm)	Fluxo/Pot. (aprox. 138lm/W)	HF (€) 5537	DALI (€) 5737
5537.045.xOL	450	400	2100 lm	149,60	195,77
5537.065.xOL	650	600	3000 lm	173,00	219,17
5537.095.xOL	950	900	4500 lm	212,17	253,96
5537.125.xOL	1250	1200	6000 lm	257,11	312,32

2700K | 3000K | 4000K | 5000K | 6500K

1-10V sob consulta.



1

Branco

código:
5xxx.xxx.10L

2

Cinza

código:
5xxx.xxx.20L

3

Cinza Satinado

código:
5x2x.xxx.30L

4

Escovado

código:
5x2x.xxx.40L

7

Grafite

código:
5xxx.xxx.70L

9

Preto

código:
5xxx.xxx.90L

0

RAL sob consulta



5520

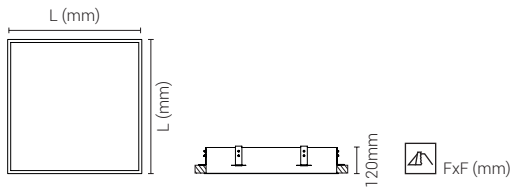
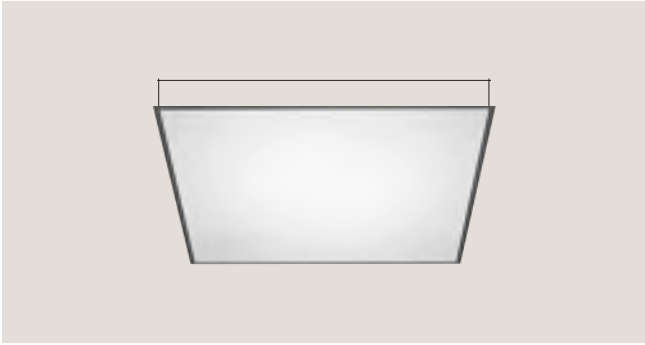

5521

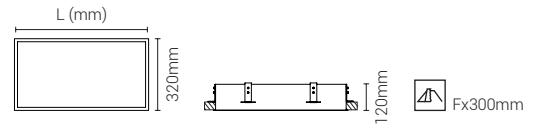
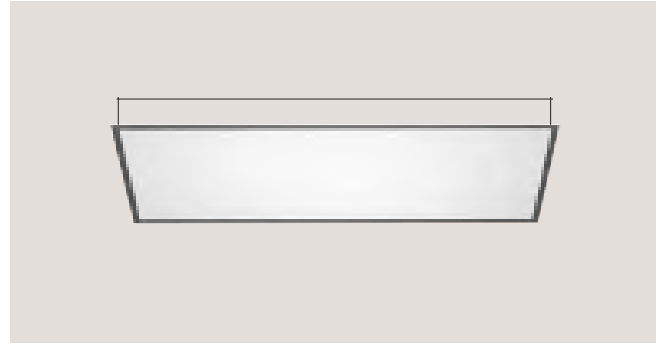

5520 | IK04 | IP43 | Módulo LED

Código	L (mm)	F (mm)	Fluxo/Pot. (aprox. 175lm/W)	HF (€) 5520	1-10V (€) 5620	DALI (€) 5720
5520.030.xOL	320	300	1250 lm	121,47	148,21	148,21
5520.060.xOL	620	600	5000 lm	239,42	271,26	271,26
5520.090.xOL	920	900	11250 lm	503,23	524,56	524,56

2700K | 3000K | 4000K | 5000K | 6500K

5521 | IK04 | IP43 | Módulo LED

Código	L (mm)	F (mm)	Fluxo/Pot. (aprox. 175lm/W)	HF (€) 5521	1-10V (€) 5621	DALI (€) 5721
5521.060.xOL	620	600	2500 lm	188,17	219,86	219,86
5521.090.xOL	920	900	3750 lm	251,04	263,22	263,22
5521.120.xOL	1220	1200	5000 lm	297,19	329,03	329,03
5521.150.xOL	1520	1500	6250 lm	367,45	378,54	378,54

2700K | 3000K | 4000K | 5000K | 6500K



Opalino

código:
5x3x.xxx.xOL



Opalino

código:
5x2x.xxx.xOL





5024

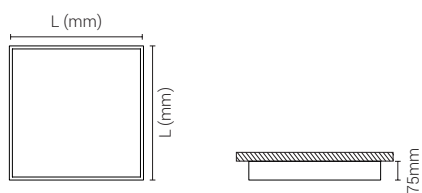

5025

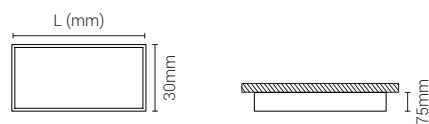

5024 | IK04 | IP43 | Módulo LED

Código	L (mm)	Fluxo/Pot. (aprox. 175lm/W)	HF (€)		DALI (€)
			5024	5124	5224
5024.030.xOL	300	1250 lm	105,99	132,72	132,72
5024.060.xOL	600	5000 lm	206,47	238,31	238,31
5024.090.xOL	900	11250 lm	435,69	457,02	457,02

3000K | 4000K | 6500K

5025 | IK04 | IP43 | Módulo LED

Código	L (mm)	Fluxo/Pot. (aprox. 175lm/W)	HF (€)		DALI (€)
			5025	5125	5225
5025.060.xOL	600	2500 lm	155,81	187,49	187,49
5025.090.xOL	900	3750 lm	204,19	216,36	216,36
5025.120.xOL	1200	5000 lm	137,72	269,56	269,56
5025.150.xOL	1500	6250 lm	314,65	327,61	327,61

3000K | 4000K | 6500K



1

Branco

código:
5x2x.xxx.10L

2

Cinza

código:
5x2x.xxx.20L

3

Cinza Satinado

código:
5x2x.xxx.30L

4

Escovado

código:
5x2x.xxx.40L

7

Grafite

código:
5x2x.xxx.70L

9

Preto

código:
5x2x.xxx.90L

0

RAL sob consulta



5026

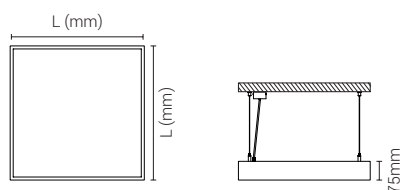

5027

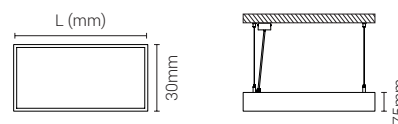

5026 | IK04 | IP43 | Módulo LED

Código	L (mm)	Fluxo/Pot. (aprox. 175lm/W)	HF (€) 5026	1-10V (€) 5126	DALI (€) 5226
5026.030.xOL	300	1250 lm	133,74	160,48	160,48
5026.060.xOL	600	5000 lm	234,23	281,72	266,07
5026.090.xOL	900	11250 lm	463,45	513,29	484,78

3000K | 4000K | 6500K

5027 | IK04 | IP43 | Módulo LED

Código	L (mm)	Fluxo/Pot. (aprox. 175lm/W)	HF (€) 5027	1-10V (€) 5127	DALI (€) 5227
5027.060.xOL	600	2500 lm	183,57	215,25	215,25
5027.090.xOL	900	3750 lm	231,94	244,12	244,12
5027.120.xOL	1200	5000 lm	265,48	297,31	297,31
5027.150.xOL	1500	6250 lm	342,41	355,36	355,36

3000K | 4000K | 6500K

1 2 7 9

Standard/Incluído



5084.FSR.xXX
Florão Saliente
Redondo Ø58mm

Opção



5084.FSQ.xXX
Florão Saliente
Quadrado 58x58mm
9,36€

Opção



5084.FER.xXX
Florão Encastrado
Redondo Ø55mm
8,77€

Opção



5084.FEQ.xXX
Florão Encastrado
Quadrado 50x50mm
8,87€



5084.COS.xXX | Cabos de Suspensão
Standard/Incluído 1,5 metros
5084.xAx.xXX | Cabo de Alimentação
Standard/Incluído 1,5 metros
Outras Medidas na Página 243



Opalino
código:
5x2x.xxx.xOL



81,29€ 104,78€

Estas luminárias podem incluir estes componentes elétricos.





5524



5524 IK04 IP20 Módulo LED					
Código	L (mm)	Fluxo/Pot. (aprox. 175lm/W)	HF (€) 5524	1-10V (€) 5624	DALI (€) 5724
5524.030.xOL	300	1250 lm	158,47	187,06	187,06
5524.060.xOL	600	5000 lm	257,50	291,19	291,19
5524.090.xOL	900	11250 lm	492,75	515,93	515,93

3000K | 4000K | 6500K

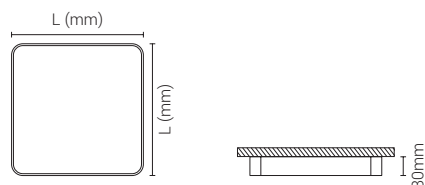

5525



5525 IK04 IP20 Módulo LED					
Código	L (mm)	Fluxo/Pot. (aprox. 175lm/W)	HF (€) 5525	1-10V (€) 5625	DALI (€) 5725
5525.060.xOL	600	2500 lm	206,84	240,38	240,38
5525.090.xOL	900	3750 lm	259,17	273,21	273,21
5525.120.xOL	1200	5000 lm	299,05	332,74	332,74
5525.150.xOL	1500	6250 lm	381,60	394,55	394,55

3000K | 4000K | 6500K

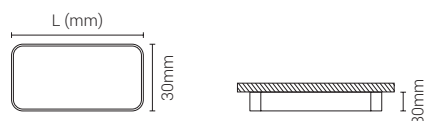

5528



5528 IK04 IP20 Módulo LED					
Código	L (mm)	Fluxo/Pot. (aprox. 183lm/W)	HF (€) 5528	1-10V (€) 5628	DALI (€) 5728
5528.208.xOL	600	2200 lm	173,74	202,33	202,33
5528.308.xOL	900	3300 lm	198,28	212,31	212,31
5528.408.xOL	1200	4400 lm	243,07	257,10	257,10
5528.508.xOL	1500	5500 lm	291,16	304,11	304,11

2700K | 3000K | 4000K | 5000K | 6500K

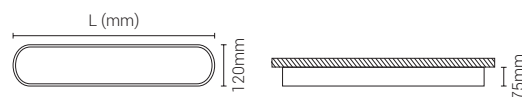

1

Branco

código:
5x2x.xxx.10L

2

Cinza

código:
5x2x.xxx.20L

7

Grafite

código:
5x2x.xxx.70L

9

Preto

código:
5x2x.xxx.90L

0

RAL sob consulta



5526



Acessórios na página 99

5526 IK04 IP20 Módulo LED					
Código	L (mm)	Fluxo/Pot. (aprox. 175lm/W)	HF (€) 5526	1-10V (€) 5626	DALI (€) 5726
5526.030.xOL	300	1250 lm	186,23	214,82	214,82
5526.060.xOL	600	5000 lm	285,26	337,71	318,95
5526.090.xOL	900	11250 lm	520,51	575,67	543,69

3000K | 4000K | 6500K

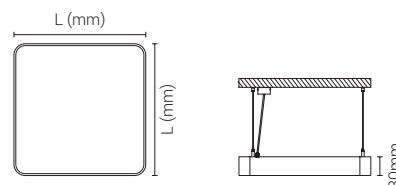

5527



Acessórios na página 99

5527 IK04 IP20 Módulo LED					
Código	L (mm)	Fluxo/Pot. (aprox. 175lm/W)	HF (€) 5527	1-10V (€) 5627	DALI (€) 5727
5527.060.xOL	600	2500 lm	234,60	268,14	268,14
5527.090.xOL	900	3750 lm	286,93	300,96	300,96
5527.120.xOL	1200	5000 lm	326,80	360,49	360,49
5527.150.xOL	1500	6250 lm	409,36	422,31	422,31

3000K | 4000K | 6500K

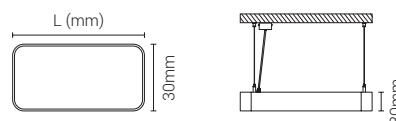

5529

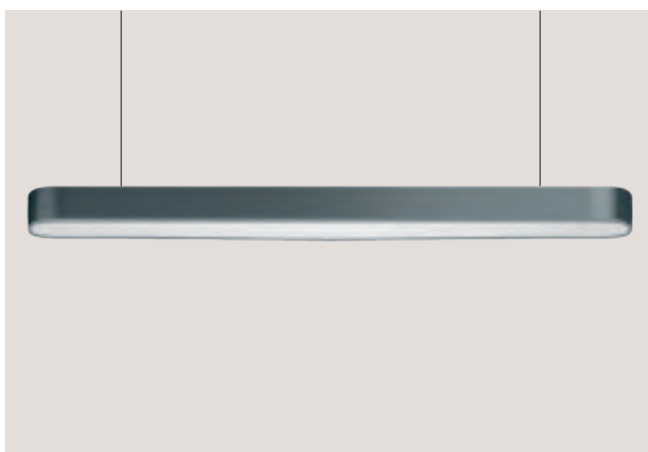

Acessórios na página 99

5529 IK04 IP20 Módulo LED					
Código	L (mm)	Fluxo/Pot. (aprox. 183lm/W)	HF (€) 5529	1-10V (€) 5629	DALI (€) 5729
5529.208.xOL	600	2200 lm	201,50	230,09	230,09
5529.308.xOL	900	3300 lm	226,04	240,07	240,07
5529.408.xOL	1200	4400 lm	270,83	284,86	284,86
5529.508.xOL	1500	5500 lm	318,92	331,87	331,87

2700K | 3000K | 4000K | 5000K | 6500K

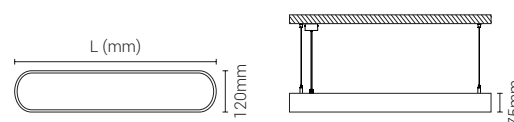

NOTA: Possibilidade de luz direta e indireta sob consulta para as versões suspensas.



Opalino

código:
5x2x.xxx.xOLKIT EMG
1 H

81,29€

KIT EMG
3 H

104,78€



Estas luminárias podem incluir estes componentes elétricos.



7038

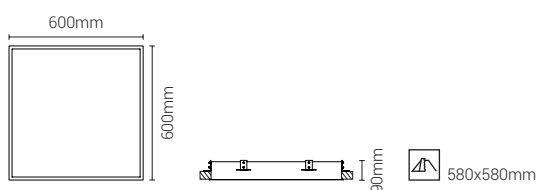

7039

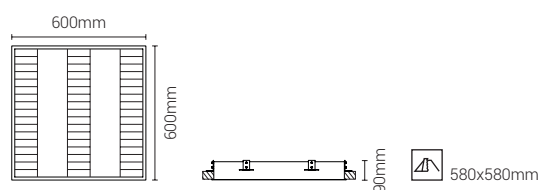

7038 | IK04 | IP40 | Módulo LED

Código	Fluxo/Pot. (aprox. 177lm/W)	HF (€) 7038	1-10V (€) 7138	DALI (€) 7238
7038.408.xOL	5000 lm	201,74	249,28	235,43

3000K | 4000K | 6500K

7039 | IK04 | IP20 | Módulo LED

Código	Saídas de Luz	Fluxo/Pot. (aprox. 183lm/W)	HF (€) 7039	1-10V (€) 7139	DALI (€) 7239
7039.310.xAL	3	4200 lm	175,07	188,02	188,02
7039.410.xAL	4	5600 lm	217,18	228,29	228,29

3000K | 4000K | 6500K



1

Branco

código:
7xxx.xxx.1xL

2

Cinza

código:
7xxx.xxx.2xL

7

Grafite

código:
7xxx.xxx.7xL

9

Preto

código:
7xxx.xxx.9xL



7048

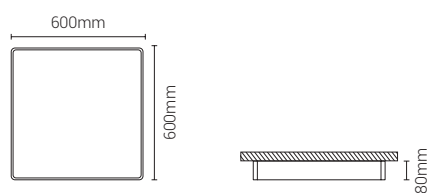

7049

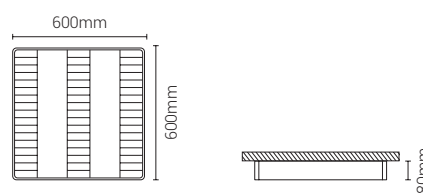

7048 | IK04 | IP40 | Módulo LED

Código	Fluxo/Pot. (aprox. 177lm/W)	HF (€) 7048	1-10V (€) 7148	DALI (€) 7248
7048.408.xOL	5000 lm	213,89	262,15	247,58

3000K | 4000K | 6500K

7049 | IK04 | IP20 | Módulo LED

Código	Saídas de Luz	Fluxo/Pot. (aprox. 183lm/W)	HF (€) 7049	1-10V (€) 7149	DALI (€) 7249
7049.310.xAL	3	4200 lm	223,26	236,21	236,21
7049.410.xAL	4	5600 lm	273,40	281,40	281,40

3000K | 4000K | 6500K



Opalino

código:
7xx8.xxx.xOL

Alumínio

código:
7xx9.xxx.xAL

81,29€

104,78€

Estas luminárias podem incluir
estes componentes elétricos.



5550

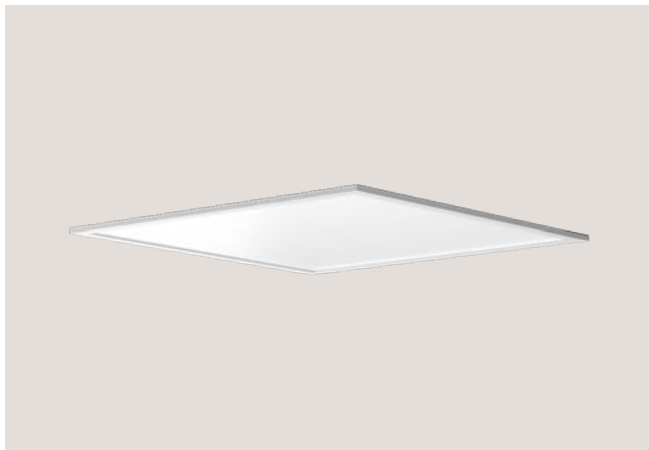

5550 IK02 IP40 Módulo LED					
Código	LxL1 (mm)	L2 (mm)	Fluxo/Pot. (aprox. 120lm/W)	HF (€) 5550	DALI (€) 5750
5550.066.1OL	600x600	9	3100 lm	52,17	85,32
5550.066.1PL	600x600	10.5	3400 lm	74,34	105,45
5550.312.1OL	300x1200	9	3100 lm	59,91	93,06
5550.312.1PL	300x1200	10.5	3400 lm	82,11	113,22
5550.612.1OL	600x1200	10.5	4900 lm	105,39	141,09
5550.612.1PL	600x1200	10.5	5350 lm	127,11	162,60

3000K | 4000K | 6500K

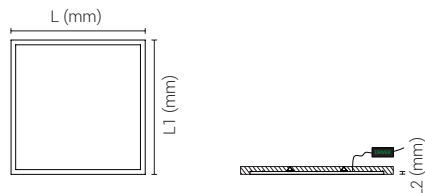

5551



5551 IK02 IP40 Módulo LED				
Código	LxL1 (mm)	Fluxo/Pot. (aprox. 120lm/W)	HF (€) 5551	DALI (€) 5751
5551.066.xOL	600x600	3100 lm	108,33	141,48
5551.066.xPL	600x600	3400 lm	130,50	161,61
5551.312.xOL	300x1200	3100 lm	127,47	160,62
5551.312.xPL	300x1200	3400 lm	149,67	180,78
5551.612.xOL	600x1200	4900 lm	196,89	232,59
5551.612.xPL	600x1200	5350 lm	218,61	254,10

3000K | 4000K | 6500K

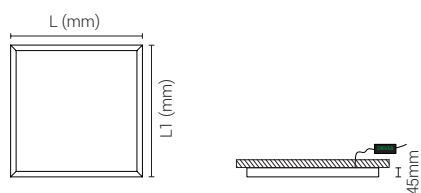

5552



5552 IK02 IP40 Módulo LED					
Código	LxL1 (mm)	L2 (mm)	Fluxo/Pot. (aprox. 120lm/W)	HF (€) 5552	DALI (€) 5752
5552.066.1OL	600x600	9	3100 lm	90,90	124,05
5552.066.1PL	600x600	10.5	3400 lm	113,07	144,18
5552.312.1OL	300x1200	9	3100 lm	98,64	131,79
5552.312.1PL	300x1200	10.5	3400 lm	120,84	151,95
5552.612.1OL	600x1200	10.5	4900 lm	144,12	179,82
5552.612.1PL	600x1200	10.5	5350 lm	165,84	201,33

3000K | 4000K | 6500K

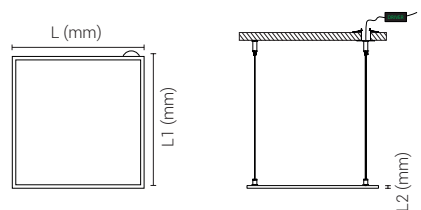

Acessórios na página 99



1

Branco

código:
5x5x.xxx.1xL

2

Cinza

código:
5x5x.xxx.2xL

7

Gráfico

código:
5x5x.xxx.7xL

9

Preto

código:
5x5x.xxx.9xL



Opalino
código:
5x5x.xxx.xOL



Prismático
código:
5x5x.xxx.xPL





Índice Fotográfico

Suspensas

Luminária suspensa, projeção de luz descendente



5005 | 5505 Pg. 108



5508 | 5509 Pg. 108



5506 Pg. 109



5532 | 5533 Pg. 110



5534 | 5535 Pg. 110



5008 | 5009 Pg. 111



5503 Pg. 111

Projetores e Calhas

Projektor de calha, projeção de luz orientável



5080 Pg. 112



5081 Pg. 112



5088 Pg. 113



5085 Pg. 113



5086 Pg. 114



5087 Pg. 114



5082 Pg. 115



5083 Pg. 115



5097 Pg. 116



5098 Pg. 116



5099 Pg. 117



5096 Pg. 117

Projektor saliente, projeção de luz orientável



6280 Pg. 112



6281 Pg. 112



6288 Pg. 113



6285 Pg. 113



6286 Pg. 114



6287 Pg. 114



6282 Pg. 115



6283 Pg. 115

Projektor de encastrar, projeção de luz orientável



6580 Pg. 112



6581 Pg. 112



6588 Pg. 113



6585 Pg. 113



6586 Pg. 114



6587 Pg. 114

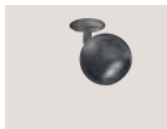

6582 Pg. 115



6583 Pg. 115

Calha saliente



5084.S Pg. 118

Calha de encastrar



5084.E Pg. 118



5005 | 5505

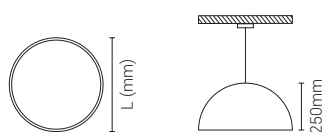

5508 | 5509

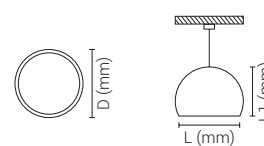
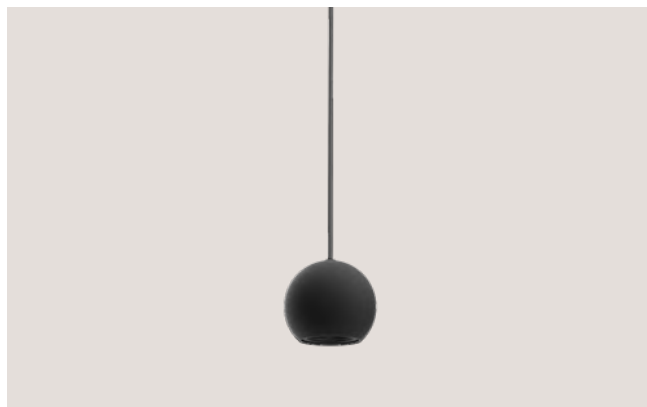

5005 | 5505 | IK03 | IP20 | E27 | Módulo LED

Código	L (mm)	Fluxo/Pot. (aprox.)	€		
			HF	1-10V	DALI
5005.100.xXX	500	E27	118,88	-	-
5005.118.xOL	500	18W - 2800 lm	203,54	237,85	237,85
5005.129.xOL	500	29W - 4100 lm	213,71	239,48	239,48
5505.100.xXX	600	E27	133,84	-	-
5505.116.xOL	600	16W - 2900 lm	253,05	278,09	278,09
5505.125.xOL	600	33W - 4700 lm	253,95	279,73	279,73

2700K | 3000K | 4000K

1 2 7 9 0 0

5508 | 5509 | IK03 | IP20 | LED - GU10 | GU10 AR111

Código	D (mm)	L (mm)	L1 (mm)	€	
				Fluxo/Pot. (aprox.)	
5508.100.xXX	100	68	85	GU10	57,14
5508.105.xXL	100	68	85	GU10 5W - 380 lm	63,18
5509.100.xXX	160	125	130	GU10	77,47
5509.116.xXL	160	125	130	GU10 AR111 15W - 1120 lm	95,94

2700K | 3000K | 4000K

1 2 7 9 0





5506

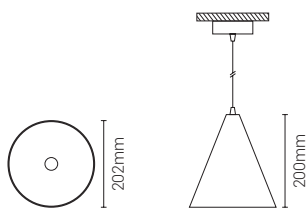

5506 | IK03 | IP20 | E27

Código	Fluxo/Pot.	€
5506.100.xXX	E27	77,72

1 2 7 9 0





5532 | 5533



Informação Importante: Driver Remoto Incluído
(não integrado na luminária)

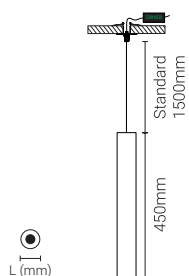

5534 | 5535



Informação Importante: Driver Remoto Incluído
(não integrado na luminária)

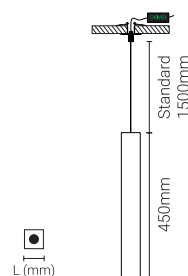

5532 5533 IK04 IP20 LED			
Código	L (mm)	Fluxo/Pot. (aprox.)	€
5532.101.xXL	25	1W - 140 lm	79,42
5532.102.xXL	25	2W - 285 lm	79,42
5533.103.xXL	38	3.3W - 504 lm	98,95

2700K | 3000K | 4000K



5534 5535 IK04 IP20 LED			
Código	L (mm)	Fluxo/Pot. (aprox.)	€
5534.101.xXL	25	1W - 140 lm	79,42
5534.102.xXL	25	2W - 285 lm	79,42
5535.103.xXL	40	3.3W - 504 lm	98,95

2700K | 3000K | 4000K

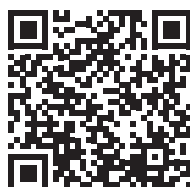



5008 | 5009

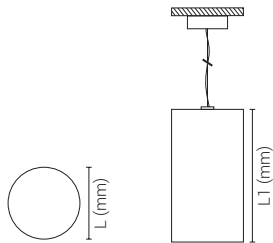

5503

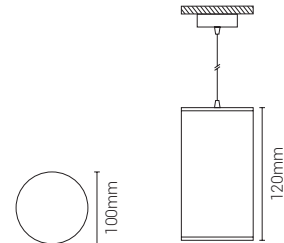

5008 | 5009 | IK03 | IP20 | LED - GU10 | GU10 AR111

Código	L (mm)	L1 (mm)	Fluxo/Pot. (aprox.)	€
5008.100.xXX	60	100	GU10	44,97
5008.105.xXL	60	100	GU10 5W - 380 lm	54,18
5009.100.xXX	116	160	GU10	63,95
5009.115.xXL	116	160	GU10 AR111 15W - 1120 lm	86,73

2700K | 3000K | 4000K

1 2 7 9 0

5503 | IK03 | IP44 | E27

Código	Fluxo/Pot. (aprox.)	€
5503.100.xOX	E27	49,73

2700K | 3000K | 4000K

1 2 7 9 0





Projektor orientável para aplicação em calha trifásica, com base saliente ou de encastrar

5080 | 6280 | 6580

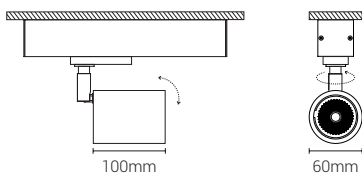

5081 | 6281 | 6581

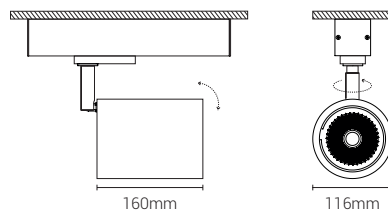

5080 6280 6580 IK03 IP20 LED GU10				
Código	Aplicação	Furação (Ø mm)	Fluxo/Pot. (aprox.)	€
5080.100.xXX	Calha	-	GU10	54,09
5080.105.xXL	Calha	-	5W - 380 lm	63,36
6280.100.xXX	Saliente	-	GU10	46,36
6280.105.xXL	Saliente	-	5W - 380 lm	55,64
6580.100.xXX	Encastrar	35	GU10	52,17
6580.105.xXL	Encastrar	35	5W - 380 lm	61,45

2700K | 3000K | 4000K

1 2 7 9

5081 6281 6581 IK03 IP20 LED - GU10 AR111 COB				
Código	Aplicação	Furação (Ø mm)	Fluxo/Pot. (aprox.)	€
5081.100.xXX	Calha	-	GU10	72,95
5081.115.xXL	Calha	-	GU10 AR111 15W - 1120 lm	96,44
5081.112.xXL	Calha	-	COB 7W - 1200 lm	123,76
5081.122.xXL	Calha	-	COB 12W - 2000 lm	123,76
5081.127.xXL	Calha	-	COB 21W - 3000 lm	124,38
6281.100.xXX	Saliente	-	GU10	64,35
6281.115.xXL	Saliente	-	GU10 AR111 15W - 1120 lm	87,84
6281.112.xXL	Saliente	-	COB 7W - 1200 lm	115,17
6281.122.xXL	Saliente	-	COB 12W - 2000 lm	115,17
6281.127.xXL	Saliente	-	COB 21W - 3000 lm	115,79
6581.100.xXX	Encastrar	60	GU10	69,51
6581.115.xXL	Encastrar	60	GU10 AR111 15W - 1120 lm	93,01
6581.112.xXL	Encastrar	60	COB 7W - 1200 lm	120,33
6581.122.xXL	Encastrar	60	COB 12W - 2000 lm	120,33
6581.127.xXL	Encastrar	60	COB 21W - 3000 lm	120,95

2700K | 3000K | 4000K

1 2 7 9





5088 | 6288 | 6588

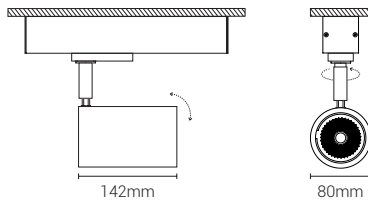

5085 | 6285 | 6585

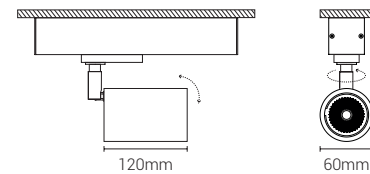

5088 6288 6588 IK03 IP20 COB				
Código	Aplicação	Furação (Ø mm)	Fluxo/Pot. (aprox.)	€
5088.112.xXL	Calha	-	7W - 1200 lm	104,78
5088.122.xXL	Calha	-	12W - 2000 lm	108,21
5088.127.xXL	Calha	-	21W - 3000 lm	109,54
6288.112.xXL	Saliente	-	7W - 1200 lm	96,19
6288.122.xXL	Saliente	-	12W - 2000 lm	99,62
6288.127.xXL	Saliente	-	21W - 3000 lm	100,95
6588.112.xXL	Encastrar	60	7W - 1200 lm	101,35
6588.122.xXL	Encastrar	60	12W - 2000 lm	104,78
6588.127.xXL	Encastrar	60	21W - 3000 lm	106,11

3000K | 4000K

1 2 7 9

5085 6285 6585 IK03 IP20 LED GU10				
Código	Aplicação	Furação (Ø mm)	Fluxo/Pot. (aprox.)	€
5085.100.xXX	Calha	-	GU10	47,09
5085.105.xXL	Calha	-	5W - 380 lm	53,75
6285.100.xXX	Saliente	-	GU10	36,82
6285.105.xXL	Saliente	-	5W - 380 lm	44,05
6585.100.xXX	Encastrar	35	GU10	43,17
6585.105.xXL	Encastrar	35	5W - 380 lm	50,04

3000K | 4000K

1 2 7 9





Projektor orientável para aplicação em calha trifásica, com base saliente ou de encastrar

5086 | 6286 | 6586

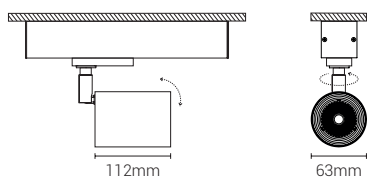

5086 6286 6586 IK03 IP20 COB				
Código	Aplicação	Furação (Ø mm)	Fluxo/Pot. (aprox.)	€
5086.108.xTL	Calha	-	8W - 580 lm	71,74
6286.108.xTL	Saliente	-	8W - 580 lm	62,03
6586.108.xTL	Encastrar	60	8W - 580 lm	68,31

3000K | 4000K

1 2 7 9 T

5087 | 6287 | 6587

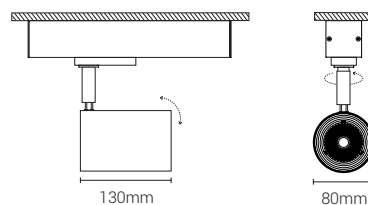

5087 6287 6587 IK03 IP20 COB				
Código	Aplicação	Furação (Ø mm)	Fluxo/Pot. (aprox.)	€
5087.115.xTL	Calha	-	15W - 1218 lm	89,99
6287.115.xTL	Saliente	-	15W - 1218 lm	82,47
6587.115.xTL	Encastrar	60	15W - 1218 lm	87,94

3000K | 4000K

1 2 7 9 T





5082 | 6282 | 6582

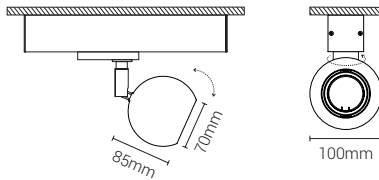

5083 | 6283 | 6583

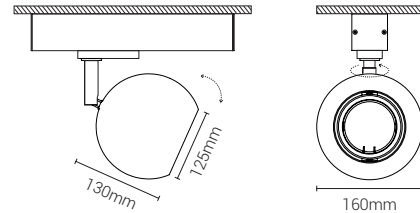

5082 | 6282 | 6582 | IK03 | IP20 | LED GU10

Código	Aplicação	Furação (Ø mm)	Fluxo/Pot. (aprox.)	€
5082.100.xXX	Calha	-	GU10	55,82
5082.105.xXL	Calha	-	5W - 380 lm	65,09
6282.100.xXX	Saliente	-	GU10	46,30
6282.105.xXL	Saliente	-	5W - 380 lm	55,57
6582.100.xXX	Encastrar	35	GU10	52,11
6582.105.xXL	Encastrar	35	5W - 380 lm	61,39

2700K | 3000K | 4000K

1 2 7 9

5083 | 6283 | 6583 | IK03 | IP20 | LED GU10 AR111

Código	Aplicação	Furação (Ø mm)	Fluxo/Pot. (aprox.)	€
5083.100.xXX	Calha	-	GU10	75,05
5083.115.xXL	Calha	-	15W - 1120 lm	98,54
6283.100.xXX	Saliente	-	GU10	66,45
6283.115.xXL	Saliente	-	15W - 1120 lm	89,95
6583.100.xXX	Encastrar	60	GU10	71,62
6583.115.xXL	Encastrar	60	15W - 1120 lm	95,11

2700K | 3000K | 4000K

1 2 7 9





5097

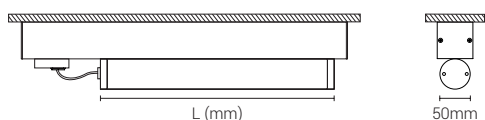
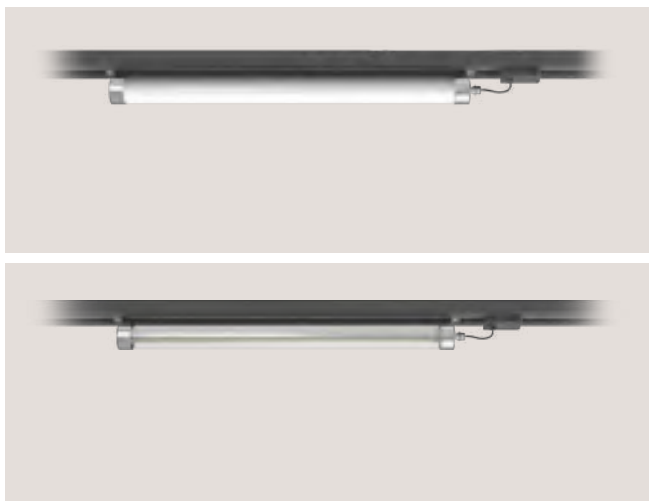

5098

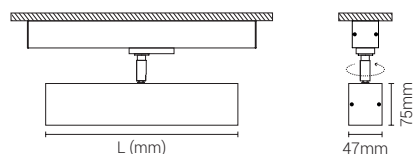
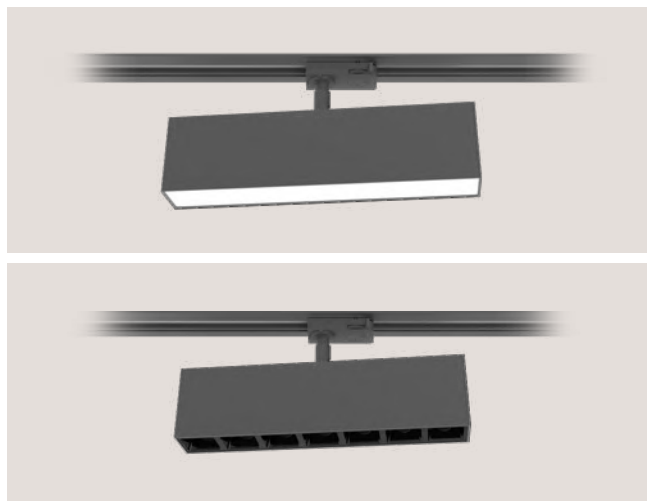

5097 IK02 IP20 LED			
Código	L (mm)	Fluxo/Pot. (aprox. 183lm/W)	€
5097.032.4xL	320	1300 lm	94,37
5097.061.4xL	610	2600 lm	99,43

2700K | 3000K | 4000K | 5000K | 6500K



5098 IP20 IK03 LED					
Código	L (mm)	Acabamento das Lentes	Fluxo/Pot. (aprox.)	HF (€) 5098	DALI (€) 5298
5098.029.xOL	290	-	6W - 1100 lm	68,31	93,44
5098.043.xOL	430	-	9W - 1650 lm	68,19	103,14
5098.057.xOL	570	-	14W - 2200 lm	73,16	108,12
5098.L18.xTL	190	Metalizado	5W - 700 lm	90,38	115,51
5098.L36.xTL	370	Metalizado	10W - 1400 lm	120,92	140,57
5098.L28.xTL	290	Branco Preto	7,7W - 1300 lm	74,31	109,26
5098.L56.xTL	570	Branco Preto	15,4W - 2600 lm	106,14	125,89

2700K | 3000K | 4000K | 5000K | 6500K



Nota: O acabamento do código principal refere-se ao corpo da luminária.
Já o acabamento pretendido para a lente (branco/preto) tem de ser especificado separadamente.





5099

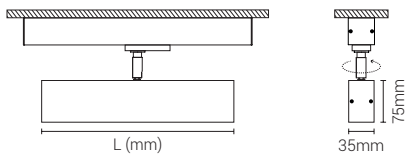
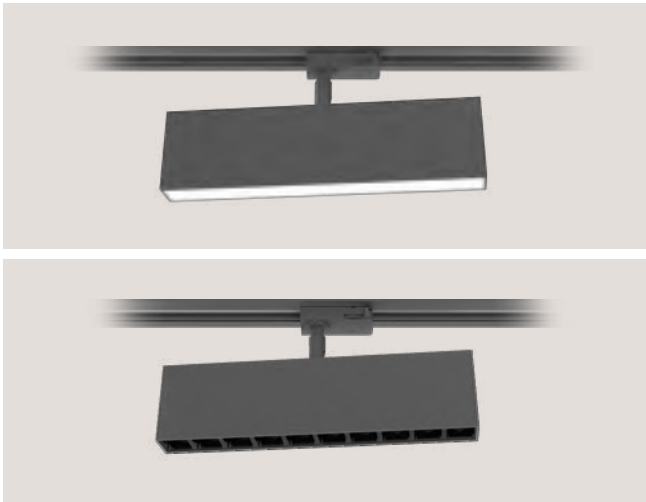

5096

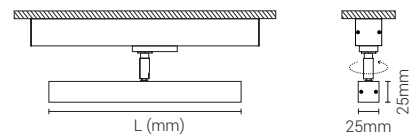
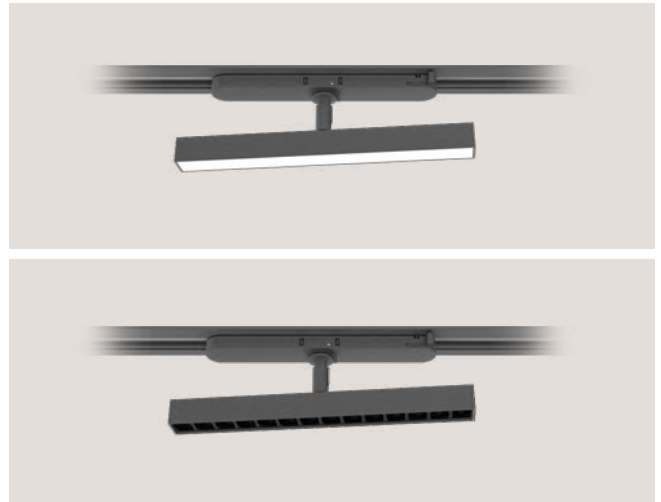

5099 | IK03 | IP20 | LED

Código	L (mm)	Acabamento das Lentes	Fluxo/Pot. (aprox.)	HF (€) 5099	DALI (€) 5299
5099.029.xOL	290	-	6W - 1100 lm	57,12	92,08
5099.043.xOL	430	-	9W - 1650 lm	67,91	102,87
5099.057.xOL	570	-	14W - 2200 lm	69,98	105,09
5099.L14.xTL	150	Branco Preto	5W - 700 lm	79,50	-
5099.L24.xTL	290	Branco Preto	10W - 1400 lm	90,13	125,55
5099.L28.xTL	300	Branco Preto	12W - 1700 lm	107,07	148,21
5099.L56.xTL	580	Branco Preto	24W - 3400 lm	183,38	197,63

2700K | 3000K | 4000K | 5000K | 6500K



Nota: O acabamento do código principal refere-se ao corpo da luminária.
Já o acabamento pretendido para a lente (branco/preto) tem de ser especificado separadamente.

5096 | IK03 | IP20 | LED

Código	L (mm)	Acabamento das Lentes	Fluxo/Pot. (aprox.)	HF (€) 5096	DALI (€) 5296
5096.029.xOL	290	-	6W - 980 lm	50,01	65,47
5096.057.xOL	570	-	11W - 1960 lm	58,39	73,84
5096.L14.xTL	150	White Black	5W - 700 lm	65,25	80,70
5096.L28.xTL	290	White Black	6,5W - 1000 lm	61,82	77,27
5096.L56.xTL	570	White Black	13W - 2000 lm	84,20	99,09

2700K | 3000K | 4000K | 5000K | 6500K



Nota: O acabamento do código principal refere-se ao corpo da luminária.
Já o acabamento pretendido para a lente (branco/preto) tem de ser especificado separadamente.





Calha trifásica

5084.S



5084.S | IK03 | IP20

Código	L (mm)	€
5084.S10.xXX	1000	29,05
5084.S20.xXX	2000	55,36
5084.S30.xXX	3000	83,07

1 2 7 9 0

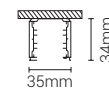
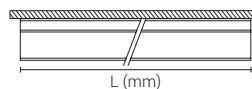

5084.E



5084.E | IK03 | IP20

Código	L (mm)	€
5084.E10.xXX	1000	33,19
5084.E20.xXX	2000	63,60
5084.E30.xXX	3000	93,38

1 2 7 9 0

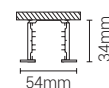
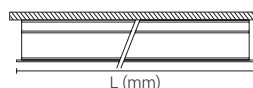

Acessórios

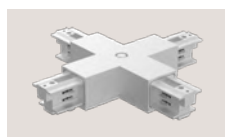

5084.UNX.xXX
Conector em X
47,10€

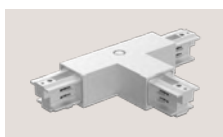

5084.UTD.xXX (direita)
5084.UTE.xXX (esquerda)
Conector em T
36,27€



5084.ULD.xXX (direita)
5084.ULE.xXX (esquerda)
Conector em L
23,37€



5084.ASD.xXX (direita)
5084.ASE.xXX (esquerda)
Alimentador Saliente
10,75€



5084.AED.xXX (direita)
5084.AEE.xXX (esquerda)
Alimentador de Encastrar
11,56€



5084.ALC.xXX
Alimentação Central Saliente
21,57€



5084.ALE.xXX
Alimentação Central de Encastrar
23,24€



5084.UNF.xXX
União Flexível
33,25€



5084.UNE.xXX
União Elétrica
7,20€



5084.MUA.xXX
Multi-adaptador
11,07€



5084.TOR.xXX
Topo de Remate Saliente
1,20€



5084.TER.xXX
Topo de Remate de Encastrar
1,36€



5084.FSQ.xXX
Florão Saliente Quadrado
58x58mm 9,36€ | 82x82mm 14,96€



5084.FSR.xXX
Florão Saliente Redondo
Ø58mm 6,30€ | Ø82mm 8,62€



5084.FER.xXX
Florão Encastrado Redondo
Ø55mm 8,77€ | Ø80mm 9,24€



5084.FEQ.xXX
Florão Encastrado Quadrado
50x50mm 8,87€ | 80x80mm 9,45€



5084.MOL.xXX
Mola de Fixação
1,89€ / unidade

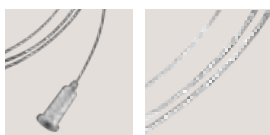

5084.COS.xXX
Cabos de Suspensão
e Alimentação

Standard/Incluído
1,5 metros
Outras Medidas na Página 243



Índice Fotográfico

Espelhos de Luz

▶ Espelho de luz saliente, projeção de luz frontal



5074 | 5574 Pg. 122



5076 | 5576 Pg. 122



5078 | 5578 Pg. 122



5075 | 5575 Pg. 123



5077 | 5577 Pg. 123



5079 | 5579 Pg. 123

▶ Espelho de luz saliente, projeção de luz interior



5570 Pg. 124

▶ Espelho de luz saliente, projeção de luz frontal



5571 Pg. 124

▶ Espelho de luz saliente, projeção de luz exterior



5572 Pg. 124

Saídas de Emergência

▶ Saída de emergência suspensa, projeção de luz descendente



5032 Pg. 126



5045 Pg. 127

▶ Saída de emergência de encastrar com aba de remate, projeção de luz descendente



5030 Pg. 126

▶ Saída de emergência saliente, projeção de luz descendente



5031 Pg. 126



5044 Pg. 127

▶ Saída de emergência saliente, projeção de luz frontal



5033 Pg. 126



5046 Pg. 127



5074 | 5574

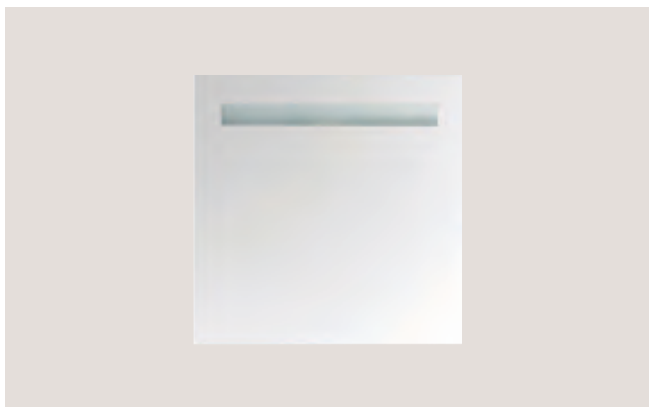

5074 5574 IP44 Módulo LED		
Código	Fluxo/Pot. (aprox. 166lm/W)	€
5074.205.EFL	2000 lm	205,14
5574.205.EFL	2000 lm	220,60

2700K | 3000K | 4000K | 5000K | 6500K

E F

5074

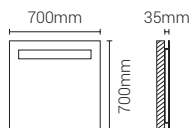

5574

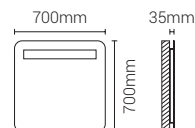

5076 | 5576



5076 5576 IP44 Módulo LED		
Código	Fluxo/Pot. (aprox. 166lm/W)	€
5076.305.EFL	3000 lm	235,68
5576.305.EFL	3000 lm	251,14

2700K | 3000K | 4000K | 5000K | 6500K

E F

5076

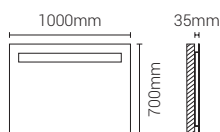

5576

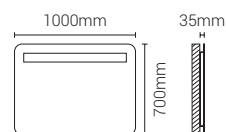

5078 | 5578



5078 5578 IP44 Módulo LED		
Código	Fluxo/Pot. (aprox. 166lm/W)	€
5078.405.EFL	4000 lm	262,23
5578.405.EFL	4000 lm	277,69

2700K | 3000K | 4000K | 5000K | 6500K

E F

5078

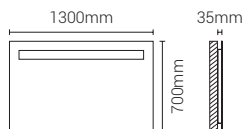

5578

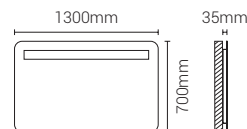

5574



5576



5578





5075 | 5575

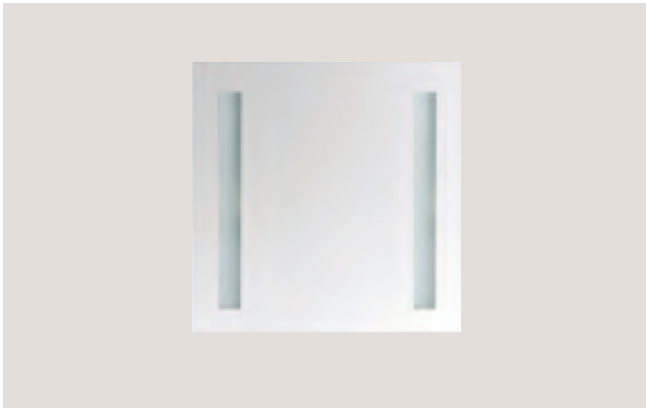

5075 5575 IP44 Módulo LED		
Código	Fluxo/Pot. (aprox. 166lm/W)	€
5075.405.EFL	4000 lm	253,27
5575.405.EFL	4000 lm	264,06

2700K | 3000K | 4000K | 5000K | 6500K



5075

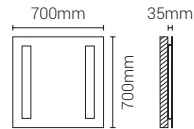

5575

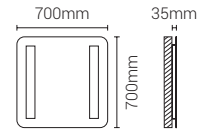

5077 | 5577



5077 5577 IP44 Módulo LED		
Código	Fluxo/Pot. (aprox. 166lm/W)	€
5077.405.EFL	4000 lm	282,60
5577.405.EFL	4000 lm	290,67

2700K | 3000K | 4000K | 5000K | 6500K



5077

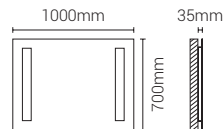

5577

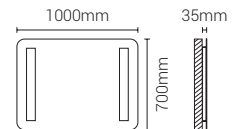

5079 | 5579



5079 5579 IP44 Módulo LED		
Código	Fluxo/Pot. (aprox. 166lm/W)	€
5079.405.EFL	4000 lm	304,18
5579.405.EFL	4000 lm	319,63

2700K | 3000K | 4000K | 5000K | 6500K



5079

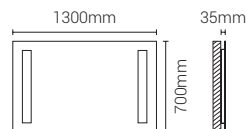

5579

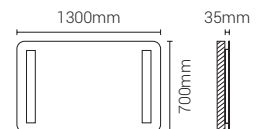

5575



5577



5579





5570



5570 IP20 Fita LED		
Código	Fluxo/Pot. (aprox. 138lm/W)	€
5570.065.xOL	3000 lm	177,48

2700K | 3000K | 4000K

1 2 7 9 0 0



5571



5571 IP20 Módulo LED		
Código	Fluxo/Pot. (aprox. 184lm/W)	€
5571.073.xOL	6700 lm	283,90

2700K | 3000K | 4000K

1 2 7 9 0 0

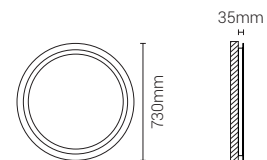

5572



5572 IP20 Fita LED		
Código	Fluxo/Pot. (aprox. 138lm/W)	€
5572.070.xOL	3000 lm	180,66

2700K | 3000K | 4000K

1 2 7 9 0 0

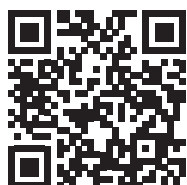
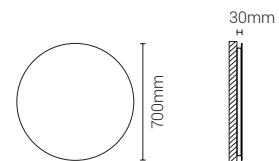

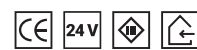



5032



Sistema de ligação para telecomando

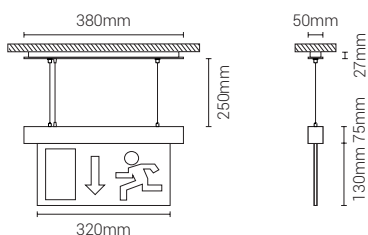

5032 | IK04 | IP40 | LED

Código	Fluxo/Pot. (aprox.)	€
5032.124.xXL	2,4W	178,04

2700K | 3000K | 4000K

1 2 7 9

5030



Sistema de ligação para telecomando

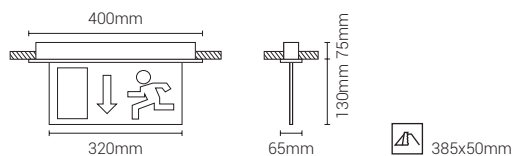

5030 | IK04 | IP40 | LED

Código	Fluxo/Pot. (aprox.)	€
5030.124.xXL	2,4W	152,17

2700K | 3000K | 4000K

1 2 7 9

5031



Sistema de ligação para telecomando

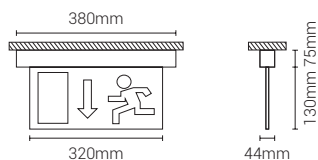

5031 | IK04 | IP40 | LED

Código	Fluxo/Pot. (aprox.)	€
5031.124.xXL	2,4W	149,41

2700K | 3000K | 4000K

1 2 7 9

5033



Sistema de ligação para telecomando

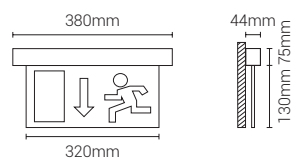

5033 | IK04 | IP40 | LED

Código	Fluxo/Pot. (aprox.)	€
5033.124.xXL	2,4W	137,67

2700K | 3000K | 4000K

1 2 7 9





5045



Sistema de ligação para telecomando

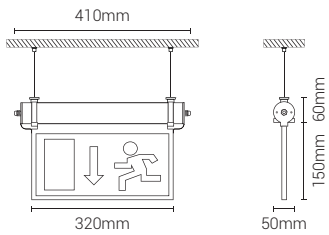

5045 IK04 IP65 LED		
Código	Fluxo/Pot. (aprox.)	€
5045.124.4xL	2,4W	152,75

2700K | 3000K | 4000K | 5000K | 6500K 4 F T

5044



Sistema de ligação para telecomando

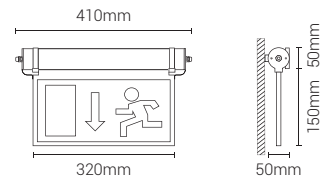

5044 IK04 IP65 LED		
Código	Fluxo/Pot. (aprox.)	€
5044.124.4xL	2,4W	130,16

2700K | 3000K | 4000K | 5000K | 6500K 4 F T

5046



Sistema de ligação para telecomando

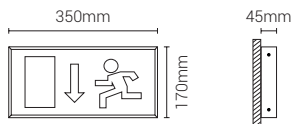

5046 IK07 IP40 LED		
Código	Fluxo/Pot. (aprox.)	€
5046.124xOL	2,4W	122,18

2700K | 3000K | 4000K | 5000K | 6500K 1 3 4 7 9 0

Pictogramas

9040.000.XXX	9040.001.XXX
9041.000.XXX	9041.001.XXX
9042.000.XXX	9042.001.XXX
9043.000.XXX	9043.001.XXX

O cliente deverá acrescentar o código do pictograma ao código da saída de emergência seleccionada, aquando da encomenda.



KIT EMG 1H30





Focos Redondos

Luminária de encastrar com aba, projeção de luz descendente



1505 Pg. 130



1502 Pg. 130



1510 Pg. 130



1003 | 6015 Pg. 130



1507 Pg. 131



1508 Pg. 131



1509 Pg. 131



1506 Pg. 131



6034 Pg. 132



4092 Pg. 132



1514 Pg. 133



1076 Pg. 133



1501 Pg. 133



1503 Pg. 133



1001 | 6001 Pg. 134



1001 V | 6001 V Pg. 134



1002 | 6002 Pg. 134



1002 V | 6002 V Pg. 134



1051 | 6051 Pg. 135



1052 | 6052 Pg. 135

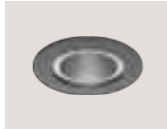

1041 | 6041 Pg. 135



1042 | 6042 Pg. 135



1009 | 6009 Pg. 136

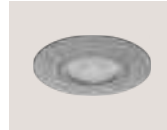

1088 | 6088 Pg. 136

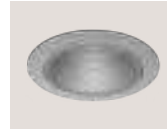

1091 Pg. 136



6036 Pg. 136



6023 Pg. 137

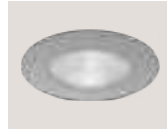

6024 Pg. 137



1027 | 6027 Pg. 137



1004 | 6016 Pg. 137



7041 Pg. 138



1089 | 6089 Pg. 138



7007 Pg. 138



7018 Pg. 138

Luminária de encastrar sem aba, projeção de luz descendente



1094 | 6074 Pg. 139



1095 | 6075 Pg. 139



1096 | 6196 Pg. 139



1097 | 6197 Pg. 139



1505

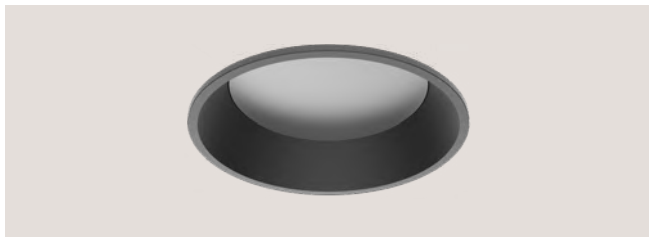

Informação Importante: Driver Remoto Incluído
(não integrado na luminária)

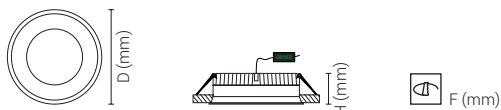

1505 | IK02 | IP44 | LED

Código	D (mm)	H (mm)	F (mm)	Fluxo/Pot. (aprox.)	HF (€) 1505	DALI (€) 1705
1505.090.xFL	90	47	82	3,1W - 420 lm	31,31	62,07
1505.118.xFL	118	52	108	7,5W - 1000 lm	34,53	66,21
1505.175.xFL	175	58	165	20W - 2500 lm	46,98	81,69

2700K | 3000K | 4000K



1502

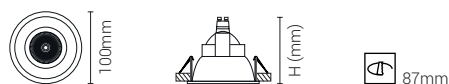

1502 | IK02 | IP20 - GU10 | IP54 - COB

Código	H (mm)	Fluxo/Pot. (aprox.)	HF (€) 1502	DALI (€) 1702
1502.100.xXX	-	GU10	15,95	-
1502.105.xXL	140	GU10 5W - 380 lm	22,13	-
1502.110.xTL	83	COB 9W - 1200 lm	39,72	79,98

2700K | 3000K | 4000K



1510



Informação Importante: Driver Remoto Incluído
(não integrado na luminária)

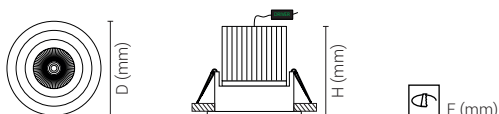

1510 | IK03 | IP20 | COB

Código	D (mm)	H (mm)	F (mm)	Fluxo/Pot. (aprox.)	HF (€) 1510	DALI (€) 1710
1510.085.xTL	85	70	70	9W - 1200 lm	40,04	69,05
1510.100.xTL	100	90	84	12,5W - 2000 lm	41,78	75,79
1510.140.xTL	140	105	123	23,6W - 3600 lm	53,04	88,77
1510.175.xTL	175	115	144	35,8W - 5000 lm	70,64	95,36

2700K | 3000K | 4000K



1003 | 6015

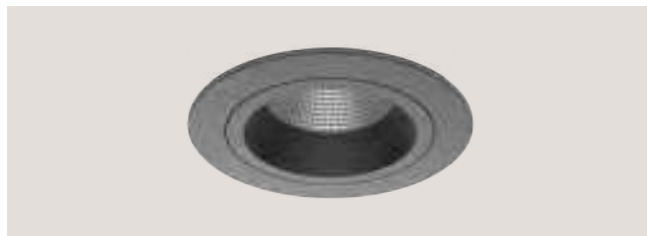

1003 | IK05 | IP20 | GU5.3

Código	H (mm)	Fluxo/Pot. (aprox.)	€
1003.100.xXX	-	GU5.3	34,36
6015.100.xXX	-	GU10	34,36
6015.105.xXL	130	GU10 5W - 380 lm	40,55
6015.060.xXL	105	COB 3W - 600 lm	69,07
6015.110.xXL	105	COB 7W - 1100 lm	69,07

2700K | 3000K | 4000K

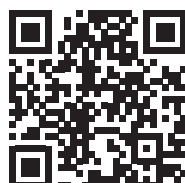



1507



Informação Importante: Driver Remoto Incluído
(não integrado na luminária)

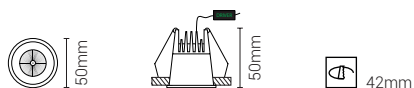

1507 IK03 IP54 LED		
Código	Fluxo/Pot. (aprox.)	€
1507.049.xTL	3W - 285 lm	28,44

2700K | 3000K | 4000K | 6500K 1 2 7 9 T

1508



Informação Importante: Driver Remoto Incluído
(não integrado na luminária)

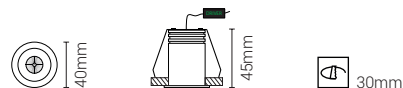

1508 IK03 IP54 LED		
Código	Fluxo/Pot. (aprox.)	€
1508.040.xTL	1,5W - 140 lm	28,18

2700K | 3000K | 4000K | 6500K 1 2 7 9 T

1509



Informação Importante: Driver Remoto Incluído
(não integrado na luminária)

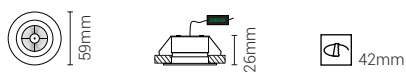

1509 IK03 IP44 LED		
Código	Fluxo/Pot. (aprox.)	€
1509.059.xTL	1,5W - 140 lm	28,44

2700K | 3000K | 4000K | 6500K 1 2 7 9 T

1506



Informação Importante: Driver Remoto Incluído
(não integrado na luminária)

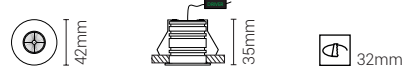

1506 IK03 IP54 LED		
Código	Fluxo/Pot. (aprox.)	€
1506.041.xTL	1,5W - 140 lm	28,65

2700K | 3000K | 4000K | 6500K 1 2 7 9 T

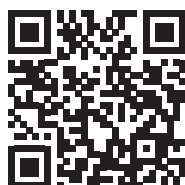



6034

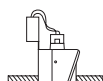

4092

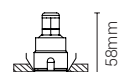

6034 | IK05 | IP20 | LED GU10

Código	H (mm)	Fluxo/Pot. (aprox.)	€
6034.100.xXX	-	GU10	22,91
6034.105.xXL	118	GU10 5W - 380 lm	28,99

2700K | 3000K | 4000K

1 2 4

4092 | IK03 | IP65 | LED

Código	Fluxo/Pot. (aprox.)	€
4092.112.xTL	1W - 140 lm	26,21
4092.112.8TL	1W - 140 lm	24,97
0101.103.XXX +	Driver LED 3W 350 mA	7,72
9090.000.XXX	Caixa	4,12

2700K | 3000K | 4000K | 5000K | 6500K

1 2 7 8 9 T

*Outras opções na página 243.
Driver LED não incluído.
A versão pintada é em alumínio.





1514



Informação Importante: Driver Remoto Incluído
(não integrado na luminária)

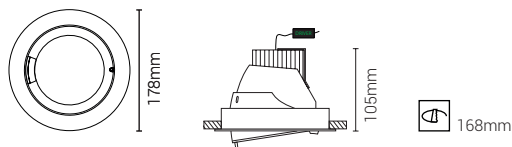

1514 IK02 IP20 COB		
Código	Fluxo/Pot. (aprox.)	€
1514.112.xTL	7W - 1200 lm	94,60
1514.122.xTL	12W - 2000 lm	94,60
1514.127.xTL	21W - 3000 lm	94,60

2700K | 3000K | 4000K

1 2 7 9 T

1076

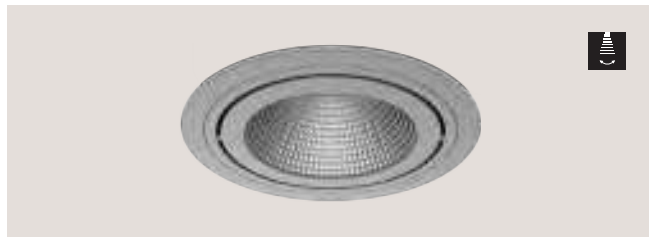

Informação Importante: Driver Remoto Incluído
(não integrado na luminária)

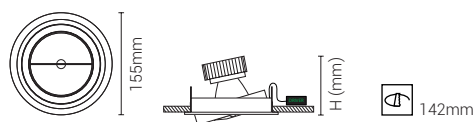

1076 IK03 IP20 G53 COB			
Código	H (mm)	Fluxo/Pot. (aprox.)	€
1076.100.xXX	-	G53	31,75
1076.112.xXL	115	7W - 1200 lm	61,42
1076.122.xXL	115	12W - 2000 lm	68,69
1076.127.xXL	115	21W - 3000 lm	71,00
1076.135.xXL	115	30W - 4200 lm	74,47

3000K | 4000K

1 2

1501



Informação Importante: Driver Remoto Incluído
(não integrado na luminária)

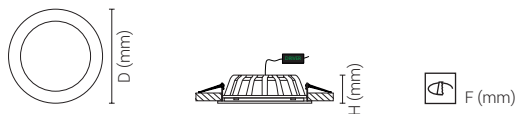

1501 IK03 IP44 LED						
Código	D (mm)	H (mm)	F (mm)	Fluxo/Pot. (aprox.)	HF (€)	DALI (€)
					1501	1701
1501.087.xFL	87	40	77	3,1W - 420 lm	31,20	60,07
1501.115.xFL	115	40	102	7,5W - 1000 lm	35,51	65,37
1501.140.xFL	140	45	125	15W - 1650 lm	42,69	74,33
1501.170.xFL	170	45	150	20W - 2500 lm	46,51	79,48
1501.220.xFL	220	45	205	25W - 3000 lm	56,88	90,27

2700K | 3000K | 4000K

1 2 7 9 0 F

1503



Informação Importante: Driver Remoto Incluído
(não integrado na luminária)

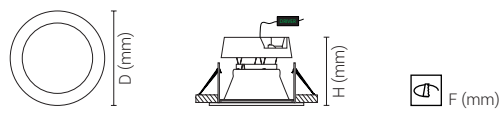

1503 IK03 IP44 LED					
Código	D (mm)	H (mm)	F (mm)	Fluxo/Pot. (aprox.)	€
					1503.113.xFL
1503.126.xFL	185	90	165	26W - 2000 lm	71,15

2700K | 3000K | 4000K

1 2 7 8 9 0 F

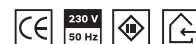



1001 | 6001



1001 V | 6001 V



1001 IK02 IP20 GU5.3		6001 IK02 IP20 LED GU10 COB	
Código	H (mm)	Fluxo/Pot. (aprox.)	€
1001.100.xxX	-	GU5.3	12,86
6001.100.xxX	-	GU10	13,88
6001.105.xXL	115	GU10 5W - 380 lm	20,06
6001.060.xXL	90	COB 3W - 600 lm	48,13
6001.110.xXL	90	COB 7W - 1100 lm	48,13

2700K | 3000K | 4000K

1 2 7 8 9 0

1001 V IK03 IP43 GU5.3		6001 V IK03 IP20 LED GU10 COB	
Código	H (mm)	Fluxo/Pot. (aprox.)	€
1001.100.xxX	-	GU5.3	16,69
6001.100.xxX	-	GU10	17,71
6001.105.xXL	120	GU10 5W - 380 lm	23,89
6001.060.xXL	95	COB 3W - 600 lm	51,96
6001.110.xXL	95	COB 7W - 1100 lm	51,96

2700K | 3000K | 4000K

1 2 7 8 9 0 M F T

1002 | 6002

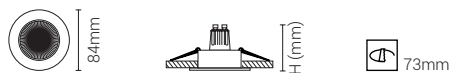

1002 V | 6002 V

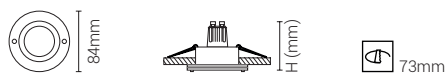

1002 IK02 IP20 GU5.3		6002 IK02 IP20 LED - GU10 COB	
Código	H (mm)	Fluxo/Pot. (aprox.)	€
1002.100.xxX	-	GU5.3 MAX 50W	17,09
6002.100.xxX	-	GU10 MAX 50W	18,11
6002.105.xXL	115	GU10 5W - 380 lm	24,29
6002.060.xXL	90	COB 3W - 600 lm	52,36
6002.110.xXL	90	COB 7W - 1100 lm	52,36

2700K | 3000K | 4000K

1 2 7 8 9 0

1002 V IK03 IP43 GU5.3		6002 V IK03 IP20 LED - GU10 COB	
Código	H (mm)	Fluxo/Pot. (aprox.)	€
1002.100.xxX	-	GU5.3 MAX 50W	21,45
6002.100.xxX	-	GU10 MAX 50W	22,47
6002.105.xXL	120	GU10 5W - 380 lm	28,65
6002.060.xXL	95	COB 3W - 600 lm	56,72
6002.110.xXL	95	COB 7W - 1100 lm	56,72

2700K | 3000K | 4000K

1 2 7 8 9 0 M F T





1051 | 6051

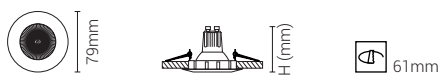

1051 IK02 IP20 GU5.3		6051 IK02 IP20 LED GU10 COB	
Código	H (mm)	Fluxo/Pot. (aprox.)	€
1051.100.xXX	-	GU5.3	3,68
6051.100.xXX	-	GU10	4,89
6051.105.xXL	115	GU10 5W - 380 lm	11,37
6051.060.xXL	90	COB 3W - 600 lm	41,85
6051.110.xXL	90	COB 7W - 1100 lm	41,85

2700K | 3000K | 4000K

1 2 4 5 7 9

1052 | 6052

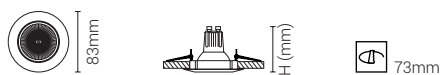

1052 IK02 IP20 GU5.3		6052 IK02 IP20 LED GU10 COB	
Código	H (mm)	Fluxo/Pot. (aprox.)	€
1052.100.xXX	-	GU5.3	4,68
6052.100.xXX	-	GU10	5,64
6052.105.xXL	115	GU10 5W - 380 lm	12,18
6052.060.xXL	90	COB 3W - 600 lm	42,65
6052.110.xXL	90	COB 7W - 1100 lm	42,65

2700K | 3000K | 4000K

1 2 4 5 7 9

1041 | 6041

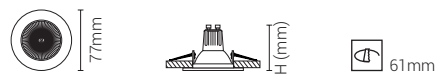
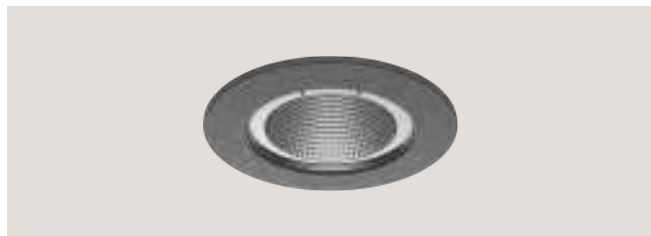

1041 IK02 IP20 GU5.3		6041 IK02 IP20 LED GU10 COB	
Código	H (mm)	Fluxo/Pot. (aprox.)	€
1041.100.xXX	-	GU5.3	4,16
6041.100.xXX	-	GU10	5,44
6041.105.xXL	115	GU10 5W - 380 lm	11,62
6041.060.xXL	90	COB 3W - 600 lm	42,13
6041.110.xXL	90	COB 7W - 1100 lm	42,13

2700K | 3000K | 4000K

1 2 4 7 9

1042 | 6042



1042 IK02 IP20 GU5.3		6042 IK02 IP20 LED GU10 COB	
Código	H (mm)	Fluxo/Pot. (aprox.)	€
1042.100.xXX	-	GU5.3	4,86
6042.100.xXX	-	GU10	6,18
6042.105.xXL	115	GU10 5W - 380 lm	12,36
6042.060.xXL	90	COB 3W - 600 lm	42,84
6042.110.xXL	90	COB 7W - 1100 lm	42,84

2700K | 3000K | 4000K

1 2 4 7 9





1009 | 6009



1009 IK02 IP20 GU5.3		6009 IK02 IP20 LED GU10 COB	
Código	H (mm)	Fluxo/Pot. (aprox.)	€
1009.100.xXX	-	GU5.3	19,60
6009.100.xXX	-	GU10	20,62
6009.105.xXL	115	GU10 5W - 380 lm	26,80
6009.060.xXL	90	COB 3W - 600 lm	54,86
6009.110.xXL	90	COB 7W - 1100 lm	54,86

2700K | 3000K | 4000K

1 2 7 8 9

1088 | 6088

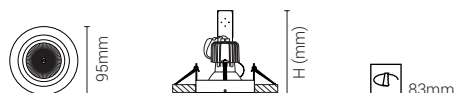

1088 IK03 IP20 GU5.3		6088 IK03 IP20 LED GU10	
Código	H (mm)	Fluxo/Pot. (aprox.)	€
1088.100.xXX	-	GU5.3	14,98
6088.100.xXX	-	GU10	14,98
6088.105.xXL	115	GU10 5W - 380 lm	21,16

2700K | 3000K | 4000K

1 2 6 7 9

1091

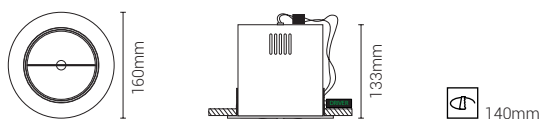
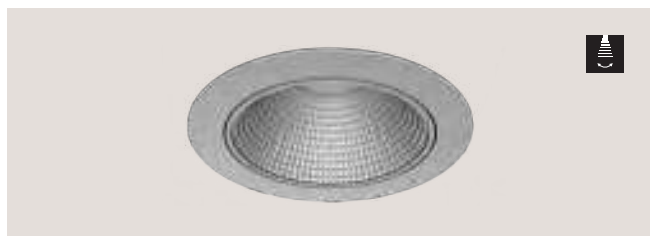

1091 IK03 IP20 G53 COB		
Código	Fluxo/Pot. (aprox.)	€
1091.100.xXX	G53	36,44
1091.112.xXL	7W - 1200 lm	66,11
1091.122.xXL	12W - 2000 lm	73,38
1091.127.xXL	21W - 3000 lm	75,70
1091.136.xXL	30W - 4200 lm	79,16

2700K | 3000K | 4000K

1 2

6036

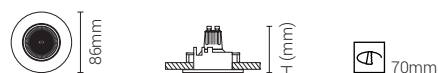

6036 IK07 IP54 LED GU10			
Código	H (mm)	Fluxo/Pot. (aprox.)	€
6036.100.xxX	-	GU10	15,97
6036.105.xXL	115	GU10 5W - 380 lm	22,15

2700K | 3000K | 4000K

1 2 7 8 9 F T

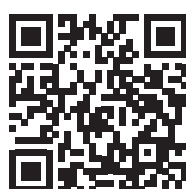



6023

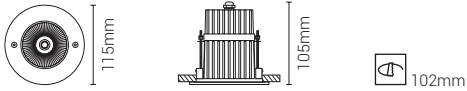
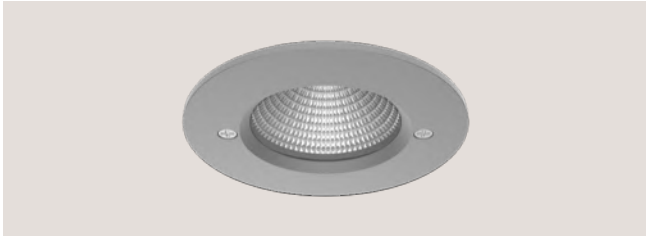

6023 IP65 COB		
Código	Fluxo/Pot. (aprox.)	€
6023.109.xxL	9W - 710 lm	98,77
6023.109.8xL	9W - 710 lm	94,18

3000K | 4000K

1 2 7 8 9 F T

6024

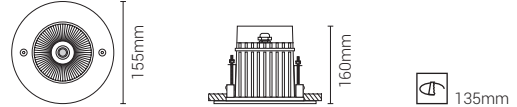
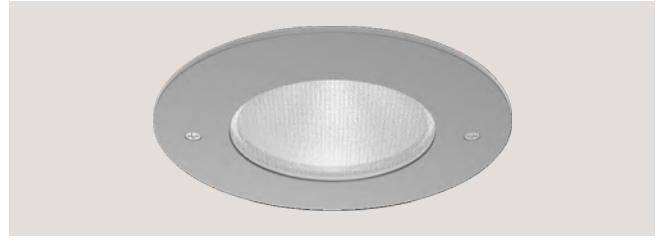

6024 IP67 COB		
Código	Fluxo/Pot. (aprox.)	€
6024.112.xPL	12.8W - 1206 lm	119,64
6024.112.8PL	12.8W - 1206 lm	121,82

2700K | 3000K | 4000K

1 2 7 8 9 P

1027 | 6027

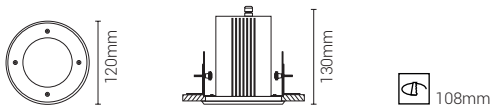

1027 IK08 IP65 GU5.3 12V		6027 IK08 IP65 LED GU10	
Código	Fluxo/Pot. (aprox.)	€	
1027.100.xxX	GU5.3	56,13	
6027.100.xxX	GU10	56,35	
6027.105.xxL	GU10 5W - 380 lm	62,53	

2700K | 3000K | 4000K

1 2 7 8 9 F T

1004 | 6016

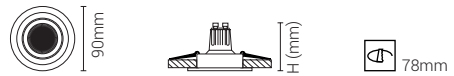
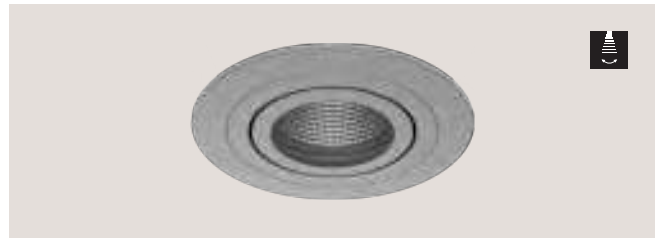

1004 IK03 IP20 GU5.3 12V		6016 IK03 IP20 LED GU10 COB	
Código	H (mm)	Fluxo/Pot. (aprox.)	€
1004.100.xXX	-	GU5.3	35,70
6016.100.xXX	-	GU10	35,70
6016.105.xXL	115	GU10 5W - 380 lm	41,88
6016.060.xXL	90	COB 3W - 600 lm	70,41
6016.110.xXL	90	COB 7W - 1100 lm	70,41

2700K | 3000K | 4000K

1 2 7 8 9





7041

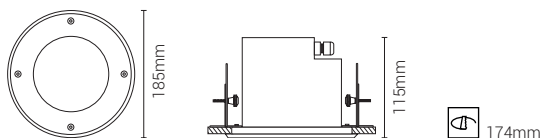

7041 IP65 LED GU10-AR111		
Código	Fluxo/Pot. (aprox.)	€
7041.115.xxL	15W - 1120 lm	177,51

2700K | 3000K | 4000K

1 2 7 8 9 F T

1089 | 6089

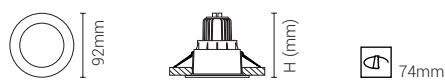

1089 IK03 IP44 GU5.3		6089 IK03 IP44 LED GU10	
Código	H (mm)	Fluxo/Pot. (aprox.)	€
1089.100.xFX	-	GU5.3	13,72
6089.100.xFX	-	GU10	13,72
6089.105.xFL	115	5W - 380 lm	16,85

2700K | 3000K | 4000K

1 2 4 8 F

7007



Informação Importante: Driver Remoto Incluído (não integrado na luminária)

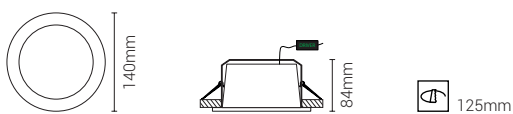

7007 IK03 IP44 LED			
Código	Fluxo/Pot. (aprox.)	HF (€)	DALI (€)
7007.114.xOL	12.6W - 1788 lm	7007 50,23	7207 83,27

3000K | 4000K

1 2 4 5 7 9 0

7018



Informação Importante: Driver Remoto Incluído (não integrado na luminária)

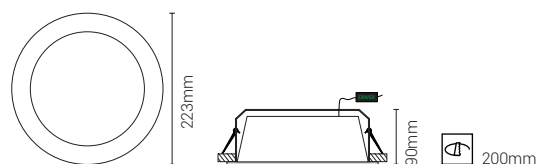

7018 IK03 IP44 LED			
Código	Fluxo/Pot. (aprox.)	HF (€)	DALI (€)
7018.127.xOL	15.8W - 2514 lm	7018 60,86	7218 95,57

1 2 4 5 7 9 0





1094 | 6074

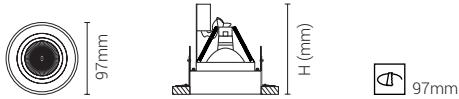

1094 IK02 IP20 GU5.3		6074 IK02 IP20 LED GU10 COB	
Código	H (mm)	Fluxo/Pot. (aprox.)	€
1094.100.xXX	-	GU5.3	37,49
6074.100.xXX	-	GU10	38,45
6074.105.xXL	145	GU10 5W - 380 lm	44,63
6074.060.xXL	120	COB 3W - 600 lm	75,48
6074.110.xXL	120	COB 7W - 1100 lm	75,48

2700K | 3000K | 4000K

1 2 7 9

1095 | 6075

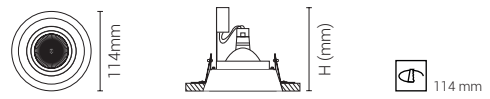

1095 IK02 IP20 GU5.3		6075 IK02 IP20 LED GU10 COB	
Código	H (mm)	Fluxo/Pot. (aprox.)	€
1095.100.xXX	-	GU5.3	37,86
6075.100.xXX	-	GU10	38,82
6075.105.xXL	140	GU10 5W - 380 lm	45,00
6075.060.xXL	115	COB 3W - 600 lm	76,90
6075.110.xXL	115	COB 7W - 1100 lm	76,90

2700K | 3000K | 4000K

1 2 7 9

1096 | 6196

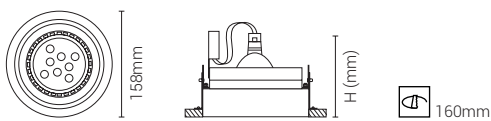
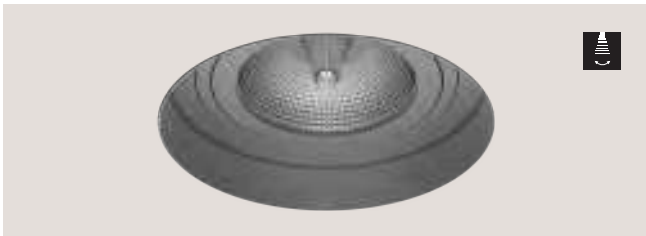

1096 IK02 IP20 G53		6196 IK02 IP20 LED GU10	
Código	H (mm)	Fluxo/Pot. (aprox.)	€
1096.100.xXX	-	G53	46,43
6196.100.xXX	-	GU10	47,38
6196.116.xXL	145	15W - 1120 lm	66,73

2700K | 3000K | 4000K

1 2 7 8 9

1097 | 6197

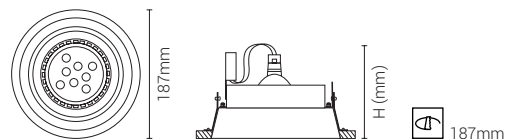

1097 IK02 IP20 G53		6197 IK02 IP20 LED GU10	
Código	H (mm)	Fluxo/Pot. (aprox.)	€
1097.100.xXX	-	G53	46,80
6197.100.xXX	-	GU10	47,75
6197.116.xXL	140	15W - 1120 lm	67,10

2700K | 3000K | 4000K

1 2 7 8 9





Índice Fotográfico

Focos Quadrados

▶ Luminária de encastrar com aba, projeção de luz descendente



1515.100

Pg. 142



1515.200

Pg. 142



1515.300

Pg. 142



1515.400

Pg. 142



1515.500

Pg. 143



Luminária de encastrar sem aba, projeção de luz descendente





1515.100



Informação Importante: Driver Remoto Incluído
(não integrado na luminária)

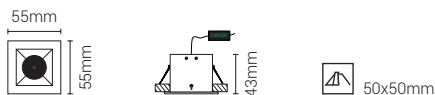

1515.100 IK03 IP20 LED		
Código	Fluxo/Pot. (aprox.)	€
1515.100.xXL	1W - 140 lm	35,39

2700K | 3000K | 4000K



1515.200



Informação Importante: Driver Remoto Incluído
(não integrado na luminária)

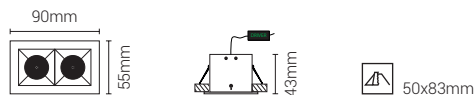

1515.200 IK03 IP20 LED		
Código	Fluxo/Pot. (aprox.)	€
1515.200.xXL	2W - 280 lm	47,57

2700K | 3000K | 4000K



1515.300



Informação Importante: Driver Remoto Incluído
(não integrado na luminária)

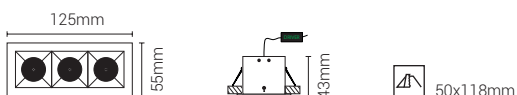

1515.300 IK03 IP20 LED		
Código	Fluxo/Pot. (aprox.)	€
1515.300.xXL	4,7W - 450 lm	62,19

2700K | 3000K | 4000K



1515.400



Informação Importante: Driver Remoto Incluído
(não integrado na luminária)

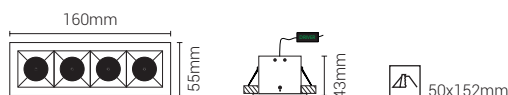

1515.400 IK03 IP20 LED		
Código	Fluxo/Pot. (aprox.)	€
1515.400.xXL	6W - 600 lm	69,64

2700K | 3000K | 4000K





1515.500



Informação Importante: Driver Remoto Incluído
(não integrado na luminária)

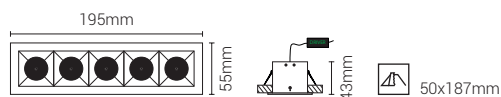

1515.500 | IK03 | IP20 | LED

Código	Fluxo/Pot. (aprox.)	€
1515.500.xXL	7W - 750 lm	81,23

2700K | 3000K | 4000K

1 2 7 9 0

1516.400



Informação Importante: Driver Remoto Incluído
(não integrado na luminária)

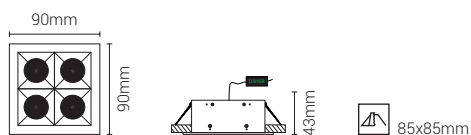

1516.400 | IK03 | IP20 | LED

Código	Fluxo/Pot. (aprox.)	€
1516.400.xXL	6W - 600 lm	76,59

2700K | 3000K | 4000K

1 2 7 9 0

1516.900



Informação Importante: Driver Remoto Incluído
(não integrado na luminária)

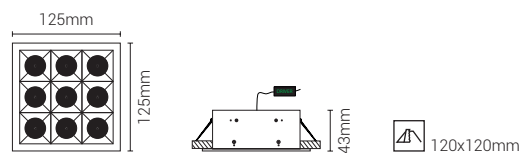

1516.900 | IK03 | IP20 | LED

Código	Fluxo/Pot. (aprox.)	€
1516.900.xXL	12W - 1350 lm	118,57

2700K | 3000K | 4000K

1 2 7 9 0

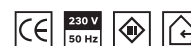



1081.100 | 6081.100

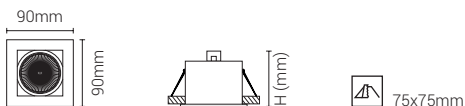
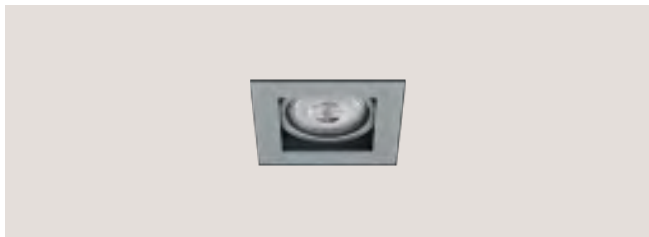

1081.100 IK02 IP20 GU5.3		6081.100 IK02 IP20 LED GU10 COB	
Código	H (mm)	Fluxo/Pot. (aprox.)	€
1081.100.xXX	-	GU5.3	15,45
6081.100.xXX	-	GU10	16,20
6081.105.xXL	115	GU10 5W - 380 lm	22,38
6081.060.xXL	90	COB 3W - 600 lm	50,91
6081.110.xXL	90	COB 7W - 1100 lm	50,91

2700K | 3000K | 4000K

1 2 7 8 9 0

1081.200 | 6081.200

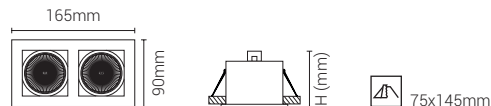

1081.200 IK02 IP20 GU5.3		6081.200 IK02 IP20 LED GU10 COB	
Código	H (mm)	Fluxo/Pot. (aprox.)	€
1081.200.xXX	-	(2x) GU5.3	29,70
6081.200.xXX	-	(2x) GU10	31,71
6081.205.xXL	115	GU10 (2x) 5W - 380 lm	44,08
6081.120.xXL	90	COB (2x) 3W - 600 lm	99,97
6081.220.xXL	90	COB (2x) 7W - 1100 lm	99,97

2700K | 3000K | 4000K

1 2 7 8 9 0

1081.300 | 6081.300

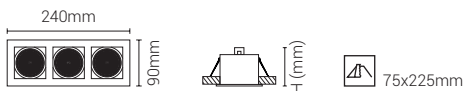
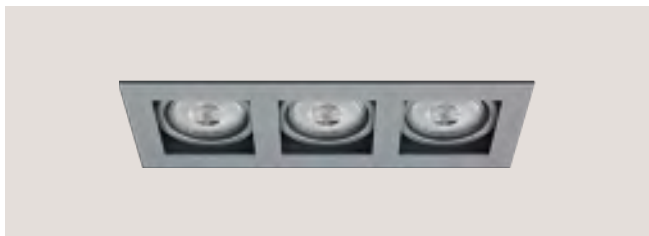

1081.300 IK02 IP20 GU5.3		6081.300 IK02 IP20 LED GU10 COB	
Código	H (mm)	Fluxo/Pot. (aprox.)	€
1081.300.xXX	-	(3x) GU5.3	44,17
6081.300.xXX	-	(3x) GU10	46,39
6081.305.xXL	115	GU10 (3x) 5W - 380 lm	65,03
6081.180.xXL	90	COB (3x) 3W - 600 lm	150,53
6081.330.xXL	90	COB (3x) 7W - 1100 lm	150,53

2700K | 3000K | 4000K

1 2 7 8 9 0

1081.400 | 6081.400

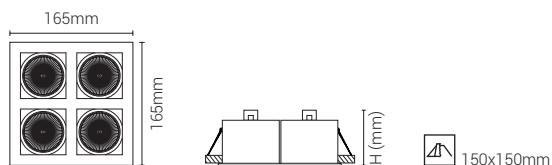
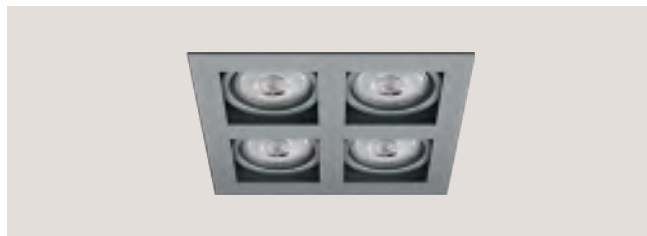

1081.400 IK02 IP20 GU5.3		6081.400 IK02 IP20 LED GU10 COB	
Código	H (mm)	Fluxo/Pot. (aprox.)	€
1081.400.xXX	-	(4x) GU5.3	57,03
6081.400.xXX	-	(4x) GU10	60,21
6081.405.xXL	115	GU10 (4x) 5W - 380 lm	84,94
6081.240.xXL	90	COB (4x) 3W - 600 lm	198,84
6081.440.xXL	90	COB (4x) 7W - 1100 lm	199,18

2700K | 3000K | 4000K

1 2 7 8 9 0





1039.100 | 6039.100

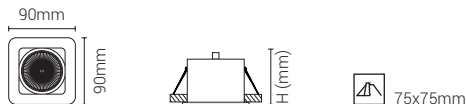

1039.100 IK02 IP20 GU5.3		6039.100 IK02 IP20 LED GU10 COB	
Código	H (mm)	Fluxo/Pot. (aprox.)	€
1039.100.xXX	-	GU5.3	15,45
6039.100.xXX	-	GU10	16,20
6039.105.xXL	115	GU10 5W - 380 lm	22,38
6039.060.xXL	90	COB 3W - 600 lm	50,91
6039.110.xXL	90	COB 7W - 1100 lm	50,91

2700K | 3000K | 4000K

1 2 7 8 9 0

1039.200 | 6039.200

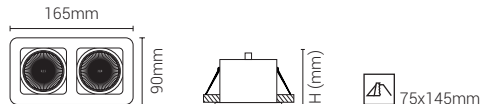

1039.200 IK02 IP20 GU5.3		6039.200 IK02 IP20 LED GU10 COB	
Código	H (mm)	Fluxo/Pot. (aprox.)	€
1039.200.xXX	-	(2x) GU5.3	29,70
6039.200.xXX	-	(2x) GU10	31,71
6039.205.xXL	115	GU10 (2x) 5W - 380 lm	44,08
6039.120.xXL	90	COB (2x) 3W - 600 lm	100,61
6039.220.xXL	90	COB (2x) 7W - 1100 lm	100,61

2700K | 3000K | 4000K

1 2 7 8 9 0

1039.300 | 6039.300

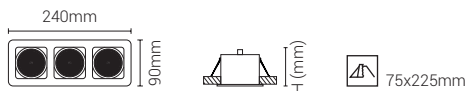
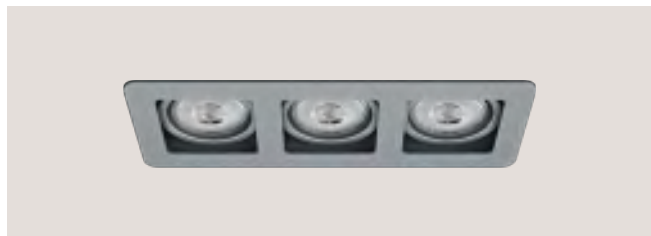

1039.300 IK02 IP20 GU5.3		6039.300 IK02 IP20 LED GU10 COB	
Código	H (mm)	Fluxo/Pot. (aprox.)	€
1039.300.xXX	-	(3x) GU5.3	44,17
6039.300.xXX	-	(3x) GU10	46,39
6039.305.xXL	115	GU10 (3x) 5W - 380 lm	65,03
6039.180.xXL	90	COB (3x) 3W - 600 lm	150,53
6039.330.xXL	90	COB (3x) 7W - 1100 lm	150,53

2700K | 3000K | 4000K

1 2 7 8 9 0

1039.400 | 6039.400

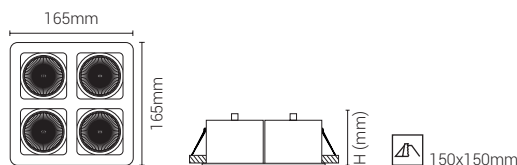

1039.400 IK02 IP20 GU5.3		6039.400 IK02 IP20 LED GU10 COB	
Código	H (mm)	Fluxo/Pot. (aprox.)	€
1039.400.xXX	-	(4x) GU5.3	57,03
6039.400.xXX	-	(4x) GU10	60,21
6039.405.xXL	115	GU10 (4x) 5W - 380 lm	84,94
6039.420.xXL	90	COB (4x) 3W - 600 lm	198,84
6039.420.xXL	90	COB (4x) 7W - 1100 lm	199,18

2700K | 3000K | 4000K

1 2 7 8 9 0

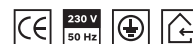



1008.100 | 6008.100

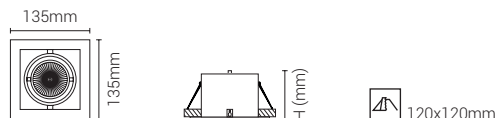

1008.100 IK02 IP20 GU5.3		6008.100 IK02 IP20 LED GU10 COB	
Código	H (mm)	Fluxo/Pot. (aprox.)	€
1008.100.xXX	-	GU5.3	34,68
6008.100.xXX	-	GU10	35,67
6008.105.xXL	115	GU10 5W - 380 lm	41,85
6008.060.xXL	90	COB 3W - 600 lm	79,25
6008.110.xXL	90	COB 7W - 1100 lm	79,25

2700K | 3000K | 4000K

1 2 7 8 9 0

1008.200 | 6008.200

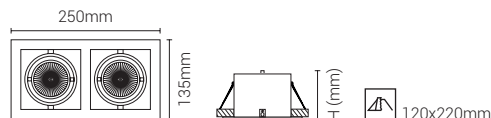

1008.200 IK02 IP20 GU5.3		6008.200 IK02 IP20 LED GU10 COB	
Código	H (mm)	Fluxo/Pot. (aprox.)	€
1008.200.xXX	-	(2x) GU5.3	66,49
6008.200.xXX	-	(2x) GU10	68,46
6008.205.xXL	115	GU10 (2x) 5W - 380 lm	80,83
6008.120.xXL	90	COB (2x) 3W - 600 lm	149,29
6008.220.xXL	90	COB (2x) 7W - 1100 lm	149,29

2700K | 3000K | 4000K

1 2 7 8 9 0

1008.300 | 6008.300

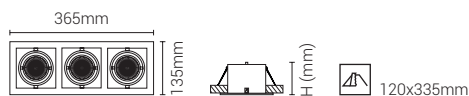
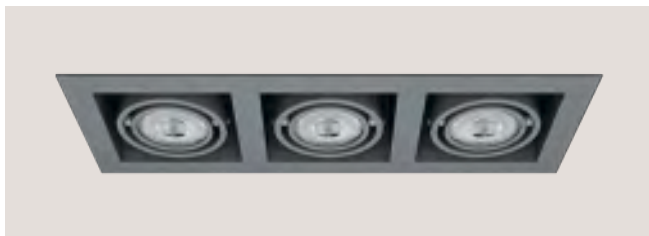

1008.300 IK02 IP20 GU5.3		6008.300 IK02 IP20 LED GU10 COB	
Código	H (mm)	Fluxo/Pot. (aprox.)	€
1008.300.xXX	-	(3x) GU5.3	92,36
6008.300.xXX	-	(3x) GU10	95,32
6008.305.xXL	115	GU10 (3x) 5W - 380 lm	113,87
6008.180.xXL	90	COB (3x) 3W - 600 lm	217,14
6008.330.xXL	90	COB (3x) 7W - 1100 lm	217,14

2700K | 3000K | 4000K

1 2 7 8 9 0

1008.400 | 6008.400

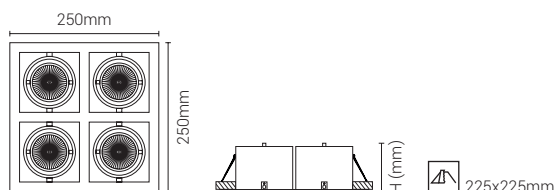

1008.400 IK02 IP20 GU5.3		6008.400 IK02 IP20 LED GU10 COB	
Código	H (mm)	Fluxo/Pot. (aprox.)	€
1008.400.xXX	-	(4x) GU5.3	128,98
6008.400.xXX	-	(4x) GU10	132,94
6008.405.xXL	115	GU10 (4x) 5W - 380 lm	157,67
6008.240.xXL	90	COB (4x) 3W - 600 lm	288,75
6008.440.xXL	90	COB (4x) 7W - 1100 lm	288,75

2700K | 3000K | 4000K

1 2 7 8 9 0

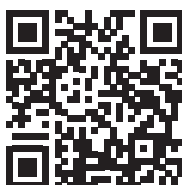



1038.100 | 6038.100

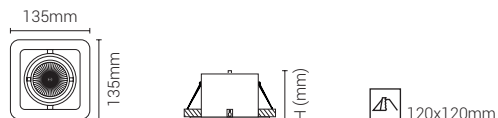

1038.100 IK02 IP20 GU5.3		6038.100 IK02 IP20 LED GU10 COB	
Código	H (mm)	Fluxo/Pot. (aprox.)	€
1038.100.xXX	-	GU5.3	34,07
6038.100.xXX	-	GU10	34,41
6038.105.xXL	115	GU10 5W - 380 lm	41,85
6038.060.xXL	90	COB 3W - 600 lm	79,25
6038.110.xXL	90	COB 7W - 1100 lm	79,25

2700K | 3000K | 4000K

1 2 7 8 9 0

1038.200 | 6038.200

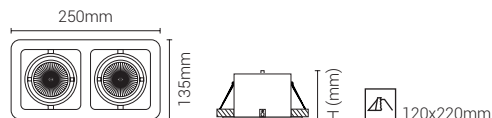

1038.200 IK02 IP20 GU5.3		6038.200 IK02 IP20 LED GU10 COB	
Código	H (mm)	Fluxo/Pot. (aprox.)	€
1038.200.xXX	-	(2x) GU5.3	66,49
6038.200.xXX	-	(2x) GU10	68,46
6038.205.xXL	115	GU10 (2x) 5W - 380 lm	80,83
6038.120.xXL	90	COB (2x) 3W - 600 lm	149,29
6038.220.xXL	90	COB (2x) 7W - 1100 lm	149,29

2700K | 3000K | 4000K

1 2 7 8 9 0

1038.300 | 6038.300

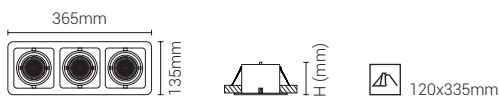

1038.300 IK02 IP20 GU5.3		6038.300 IK02 IP20 LED GU10 COB	
Código	H (mm)	Fluxo/Pot. (aprox.)	€
1038.300.xXX	-	(3x) GU5.3	92,36
6038.300.xXX	-	(3x) GU10	95,32
6038.305.xXL	115	GU10 (3x) 5W - 380 lm	113,87
6038.180.xXL	90	COB (3x) 3W - 600 lm	217,14
6038.330.xXL	90	COB (3x) 7W - 1100 lm	217,14

2700K | 3000K | 4000K

1 2 7 8 9 0

1038.400 | 6038.400

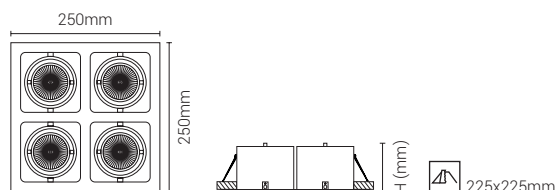

1038.400 IK02 IP20 GU5.3		6038.400 IK02 IP20 LED GU10 COB	
Código	H (mm)	Fluxo/Pot. (aprox.)	€
1038.400.xXX	-	(4x) GU5.3	128,98
6038.400.xXX	-	(4x) GU10	132,94
6038.405.xXL	115	GU10 (4x) 5W - 380 lm	157,67
6038.240.xXL	90	COB (4x) 3W - 600 lm	288,75
6038.440.xXL	90	COB (4x) 7W - 1100 lm	288,75

2700K | 3000K | 4000K

1 2 7 8 9 0

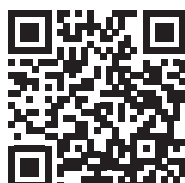



1007.100 | 6107.100

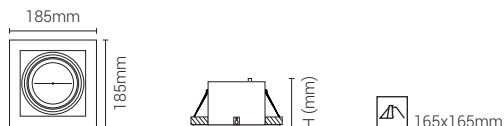

1007.100 IK02 IP20 GU5.3		6107.100 IK02 IP20 GU10 COB	
Código	H (mm)	Fluxo/Pot. (aprox.)	€
1007.100.xXX	-	GU5.3	39,72
6107.100.xXX	-	GU10	40,71
6107.115.xXL	110	GU10 15W - 1120 lm	60,05
6107.112.xXL	120	COB 7W - 1200 lm	70,38
6107.122.xXL	120	COB 12W - 2000 lm	77,65
6107.127.xXL	120	COB 21W - 3000 lm	79,96
6107.135.xXL	120	COB 30W - 4200 lm	83,43

2700K | 3000K | 4000K

1 2 7 8 9 0

1007.200 | 6107.200

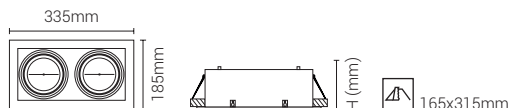

1007.200 IK02 IP20 GU5.3		6107.200 IK02 IP20 GU10 COB	
Código	H (mm)	Fluxo/Pot. (aprox.)	€
1007.200.xXX	-	(2x) GU5.3	68,83
6107.200.xXX	-	(2x) GU10	70,81
6107.215.xXL	110	GU10 (2x) 15W - 1120 lm	109,50
6107.212.xXL	120	COB (2x) 7W - 1200 lm	130,16
6107.222.xXL	120	COB (2x) 12W - 2000 lm	144,70
6107.227.xXL	120	COB (2x) 21W - 3000 lm	149,32
6107.235.xXL	120	COB (2x) 30W - 4200 lm	156,27

2700K | 3000K | 4000K

1 2 7 8 9 0

1007.300 | 6107.300



1007.300 IK02 IP20 GU5.3		6107.300 IK02 IP20 GU10 COB	
Código	H (mm)	Fluxo/Pot. (aprox.)	€
1007.300.xXX	-	(3x) GU5.3	99,90
6107.300.xXX	-	(3x) GU10	102,87
6107.315.xXL	110	GU10 (3x) 15W - 1120 lm	160,90
6107.312.xXL	120	COB (3x) 7W - 1200 lm	191,88
6107.322.xXL	120	COB (3x) 12W - 2000 lm	213,70
6107.327.xXL	120	COB (3x) 21W - 3000 lm	220,63
6107.335.xXL	120	COB (3x) 30W - 4200 lm	231,05

2700K | 3000K | 4000K

1 2 7 8 9 0

1007.400 | 6107.400



1007.400 IK02 IP20 GU5.3		6107.400 IK02 IP20 GU10 COB	
Código	H (mm)	Fluxo/Pot. (aprox.)	€
1007.400.xXX	-	(4x) GU5.3	126,60
6107.400.xXX	-	(4x) GU10	130,56
6107.415.xXL	110	GU10 (4x) 15W - 1120 lm	207,94
6107.412.xXL	120	COB (4x) 7W - 1200 lm	249,25
6107.422.xXL	120	COB (4x) 12W - 2000 lm	278,34
6107.427.xXL	120	COB (4x) 21W - 3000 lm	287,58
6107.435.xXL	120	COB (4x) 30W - 4200 lm	301,47

2700K | 3000K | 4000K

1 2 7 8 9 0





1037.100 | 6137.100

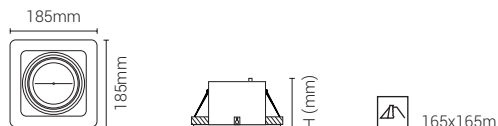

1037.100 IK02 IP20 GU5.3		6137.100 IK02 IP20 GU10 COB	
Código	H (mm)	Fluxo/Pot. (aprox.)	€
1037.100.xXX	-	GU5.3	39,72
6137.100.xXX	-	GU10	40,71
6137.115.xXL	110	GU10 15W - 1120 lm	60,05
6137.112.xXL	120	COB 7W - 1200 lm	70,38
6137.122.xXL	120	COB 12W - 2000 lm	77,65
6137.127.xXL	120	COB 21W - 3000 lm	79,96
6137.135.xXL	120	COB 30W - 4200 lm	83,43

2700K | 3000K | 4000K

1 2 7 8 9 0

1037.200 | 6137.200

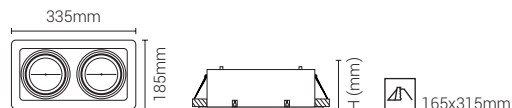

1037.200 IK02 IP20 GU5.3		6137.200 IK02 IP20 GU10 COB	
Código	H (mm)	Fluxo/Pot. (aprox.)	€
1037.200.xXX	-	(2x) GU5.3	68,83
6137.200.xXX	-	(2x) GU10	70,81
6137.215.xXL	110	GU10 (2x) 15W - 1120 lm	109,50
6137.212.xXL	120	COB (2x) 7W - 1200 lm	130,16
6137.222.xXL	120	COB (2x) 12W - 2000 lm	144,70
6137.227.xXL	120	COB (2x) 21W - 3000 lm	149,32
6137.235.xXL	120	COB (2x) 30W - 4200 lm	156,27

2700K | 3000K | 4000K

1 2 7 8 9 0

1037.300 | 6137.300



1037.300 IK02 IP20 GU5.3		6137.300 IK02 IP20 GU10 COB	
Código	H (mm)	Fluxo/Pot. (aprox.)	€
1037.300.xXX	-	(3x) GU5.3	99,90
6137.300.xXX	-	(3x) GU10	102,87
6137.315.xXL	110	GU10 (3x) 15W - 1120 lm	160,90
6137.312.xXL	120	COB (3x) 7W - 1200 lm	191,88
6137.322.xXL	120	COB (3x) 12W - 2000 lm	213,70
6137.327.xXL	120	COB (3x) 21W - 3000 lm	220,63
6137.335.xXL	120	COB (3x) 30W - 4200 lm	231,05

2700K | 3000K | 4000K

1 2 7 8 9 0

1037.400 | 6137.400



1037.400 IK02 IP20 GU5.3		6137.400 IK02 IP20 GU10 COB	
Código	H (mm)	Fluxo/Pot. (aprox.)	€
1037.400.xXX	-	(4x) GU5.3	126,60
6137.400.xXX	-	(4x) GU10	130,56
6137.415.xXL	110	GU10 (4x) 15W - 1120 lm	207,94
6137.412.xXL	120	COB (4x) 7W - 1200 lm	249,25
6137.422.xXL	120	COB (4x) 12W - 2000 lm	278,34
6137.427.xXL	120	COB (4x) 21W - 3000 lm	287,58
6137.435.xXL	120	COB (4x) 30W - 4200 lm	301,47

2700K | 3000K | 4000K

1 2 7 8 9 0





1031.100 | 6031.100

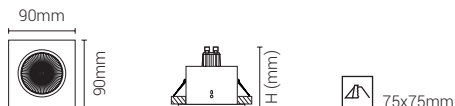
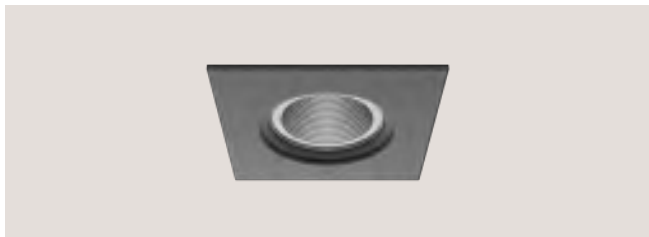

1031.100 IK02 IP20 GU5.3		6031.100 IK02 IP20 LED GU10 COB	
Código	H (mm)	Fluxo/Pot. (aprox.)	€
1031.100.xXX	-	GU5.3	15,92
6031.100.xXX	-	GU10	16,66
6031.105.xXL	115	GU10 5W - 380 lm	22,84
6031.060.xXL	90	COB 3W - 600 lm	51,37
6031.110.xXL	90	COB 7W - 1100 lm	51,37

2700K | 3000K | 4000K

1 2 7 8 9 0

1031.200 | 6031.200

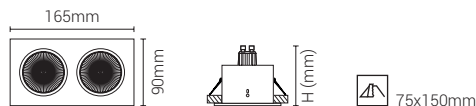

1031.200 IK02 IP20 GU5.3		6031.200 IK02 IP20 LED GU10 COB	
Código	H (mm)	Fluxo/Pot. (aprox.)	€
1031.200.xXX	-	(2x) GU5.3	29,36
6031.200.xXX	-	(2x) GU10	31,37
6031.205.xXL	115	GU10 (2x) 5W - 380 lm	43,74
6031.120.xXL	90	COB (2x) 3W - 600 lm	100,27
6031.220.xXL	90	COB (2x) 7W - 1100 lm	100,27

2700K | 3000K | 4000K

1 2 7 8 9 0

1032 | 6032

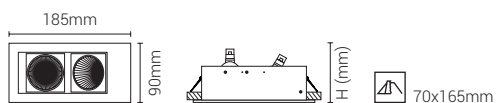

1032 IK02 IP20 GU5.3		6032 IK02 IP20 LED GU10 COB	
Código	H (mm)	Fluxo/Pot. (aprox.)	€
1032.200.xXX	-	(2x) GU5.3	33,04
6032.200.xXX	-	(2x) GU10	34,40
6032.205.xXL	165	GU10 (2x) 5W - 380 lm	46,77
6032.120.xXL	140	COB (2x) 3W - 600 lm	110,38
6032.220.xXL	140	COB (2x) 7W - 1100 lm	110,38

2700K | 3000K | 4000K

1 2 7 8 9

1033 | 6033

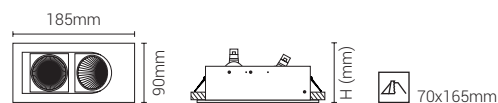

1033 IK02 IP20 GU5.3		6033 IK02 IP20 LED GU10 COB	
Código	H (mm)	Fluxo/Pot. (aprox.)	€
1033.200.xXX	-	(2x) GU5.3	33,04
6033.200.xXX	-	(2x) GU10	34,40
6033.205.xXL	165	GU10 (2x) 5W - 380 lm	46,77
6033.120.xXL	140	COB (2x) 3W - 600 lm	110,38
6033.220.xXL	140	COB (2x) 7W - 1100 lm	110,38

2700K | 3000K | 4000K

1 2 7 8 9





1084 | 6029

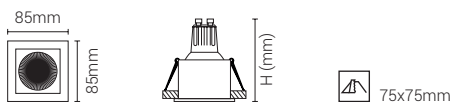
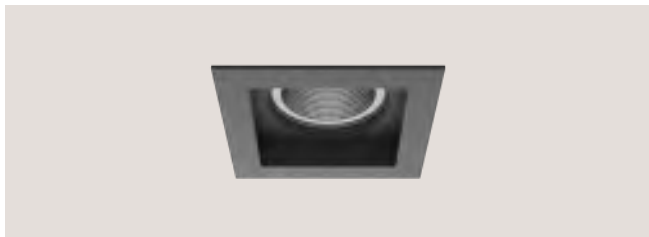

1084 IK03 IP20 GU5.3		6029 IK03 IP20 LED GU10 COB	
Código	H (mm)	Fluxo/Pot. (aprox.)	€
1084.100.xXX	-	GU5.3	11,94
1084.100.8XX	-	GU5.3	25,59
6029.100.xXX	-	GU10	11,94
6029.100.8XX	-	GU10	25,59
6029.105.xXL	135	GU10 5W - 380 lm	18,18
6029.105.8XL	135	GU10 5W - 380 lm	31,77
6029.060.xXL	110	COB 3W - 600 lm	46,71
6029.060.8XL	110	COB 3W - 600 lm	60,30
6029.110.xXL	110	COB 7W - 1100 lm	46,71
6029.110.8XL	110	COB 7W - 1100 lm	60,30

2700K | 3000K | 4000K

1 2 7 8 9





1011 | 6011

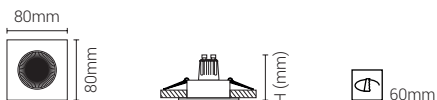

1011 IK02 IP20 GU5.3		6011 IK02 IP20 LED GU10 COB	
Código	H (mm)	Fluxo/Pot. (aprox.)	€
1011.100.xxX	-	GU5.3	12,42
6011.100.xxX	-	GU10	13,41
6011.105.xXL	115	GU10 5W - 380 lm	19,59
6011.060.xXL	90	COB 3W - 600 lm	48,06
6011.110.xXL	90	COB 7W - 1100 lm	48,06

2700K | 3000K | 4000K

1 2 7 8 9 0

1011 V | 6011 V

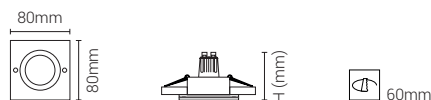

1011 V IK03 IP43 GU5.3		6011 V IK03 IP43 LED GU10 COB	
Código	H (mm)	Fluxo/Pot. (aprox.)	€
1011.100.xxX	-	GU5.3	16,92
6011.100.xxX	-	GU10	17,91
6011.105.xXL	120	GU10 5W - 380 lm	24,09
6011.060.xXL	95	COB 3W - 600 lm	52,70
6011.110.xXL	95	COB 7W - 1100 lm	52,70

2700K | 3000K | 4000K

1 2 7 8 9 0 M F T

1012 | 6012

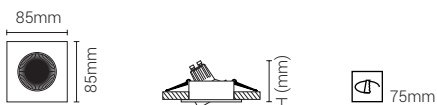

1012 IK02 IP20 GU5.3		6012 IK02 IP20 LED GU10 COB	
Código	H (mm)	Fluxo/Pot. (aprox.)	€
1012.100.xxX	-	GU5.3	18,27
6012.100.xxX	-	GU10	19,26
6012.105.xXL	115	GU10 5W - 380 lm	25,44
6012.060.xXL	90	COB 3W - 600 lm	54,09
6012.110.xXL	90	COB 7W - 1100 lm	54,09

2700K | 3000K | 4000K

1 2 7 8 9 0

1012 V | 6012 V

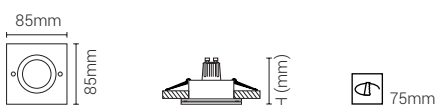

1012 V IK03 IP43 GU5.3		6012 V IK03 IP43 LED GU10 COB	
Código	H (mm)	Fluxo/Pot. (aprox.)	€
1012.100.xxX	-	GU5.3	22,71
6012.100.xxX	-	GU10	23,70
6012.105.xXL	120	GU10 5W - 380 lm	29,88
6012.060.xXL	95	COB 3W - 600 lm	58,67
6012.110.xXL	95	COB 7W - 1100 lm	58,67

2700K | 3000K | 4000K

1 2 7 8 9 0 M F T

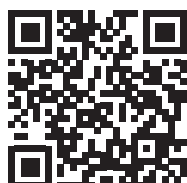



1021 | 6021

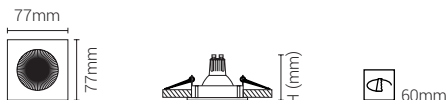

1021 IK02 IP20 GU5.3		6021 IK02 IP20 LED GU10 COB	
Código	H (mm)	Fluxo/Pot. (aprox.)	€
1021.100.xXX	-	GU5.3	4,19
6021.100.xXX	-	GU10	5,15
6021.105.xXL	115	GU10 5W - 380 lm	11,33
6021.060.xXL	90	COB 3W - 600 lm	39,65
6021.110.xXL	90	COB 7W - 1100 lm	39,65

2700K | 3000K | 4000K

1 2 4 5 7 9

1025 | 6025

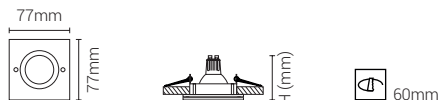

1025 IK03 IP43 GU5.3		6025 IK03 IP43 LED GU10 COB	
Código	H (mm)	Fluxo/Pot. (aprox.)	€
1025.100.xxX	-	GU5.3	7,94
6025.100.xxX	-	GU10	8,90
6025.105.xxL	120	GU10 5W - 380 lm	15,08
6025.060.xxL	95	COB 3W - 600 lm	43,40
6025.110.xxL	95	COB 7W - 1100 lm	43,40

2700K | 3000K | 4000K

1 2 4 5 7 9 M F T

1022 | 6022



1022 IK02 IP20 GU5.3		6022 IK02 IP20 LED GU10 COB	
Código	H (mm)	Fluxo/Pot. (aprox.)	€
1022.100.xXX	-	GU5.3	4,80
6022.100.xXX	-	GU10	5,76
6022.105.xXL	115	GU10 5W - 380 lm	11,94
6022.060.xXL	90	COB 3W - 600 lm	40,26
6022.110.xXL	90	COB 7W - 1100 lm	40,26

2700K | 3000K | 4000K

1 2 4 5 7 9

1026 | 6026



1026 IK03 IP43 GU5.3		6026 IK03 IP43 LED GU10 COB	
Código	H (mm)	Fluxo/Pot. (aprox.)	€
1026.100.xxX	-	GU5.3	8,99
6026.100.xxX	-	GU10	9,95
6026.105.xxL	120	GU10 5W - 380 lm	16,13
6026.060.xxL	95	COB 3W - 600 lm	44,45
6026.110.xxL	95	COB 7W - 1100 lm	44,45

2700K | 3000K | 4000K

1 2 4 5 7 9 M F T

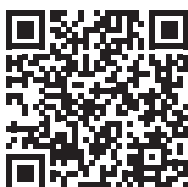



1086 | 6086

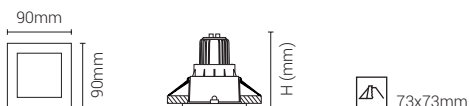

1086 IK03 IP44 GU5.3		6086 IK03 IP44 LED GU10	
Código	H (mm)	Fluxo/Pot. (aprox.)	€
1086.100.xFX	-	GU5.3	12,98
6086.100.xFX	-	GU10	12,98
6086.105.xFL	115	GU10 5W - 380 lm	19,16

2700K | 3000K | 4000K

1 2 4 8 F

1071 | 6071



1071 IK03 IP43 GU5.3		6071 IK03 IP43 LED GU10 COB	
Código	H (mm)	Fluxo/Pot. (aprox.)	€
1071.100.xxX	-	GU5.3	20,71
6071.100.xxX	-	GU10	21,57
6071.105.xxL	120	GU10 5W - 380 lm	27,76
6071.060.xxL	95	COB 3W - 600 lm	56,16
6071.110.xxL	95	COB 7W - 1100 lm	56,16

2700K | 3000K | 4000K

1 2 7 8 9 0 M F T

1061 | 6061

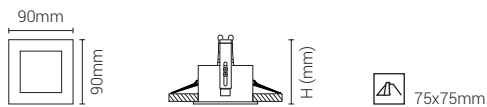

1061 IK03 IP43 GU5.3		6061 IK03 IP43 LED GU10 COB	
Código	H (mm)	Fluxo/Pot. (aprox.)	€
1061.100.xxX	-	GU5.3	20,74
6061.100.xxX	-	GU10	21,61
6061.105.xxL	115	GU10 5W - 380 lm	27,79
6061.060.xxL	90	COB 3W - 600 lm	56,19
6061.110.xxL	90	COB 7W - 1100 lm	56,19

2700K | 3000K | 4000K

1 2 7 8 9 0 M F T

7061



Informação Importante: Driver Remoto Incluído (não integrado na luminária)

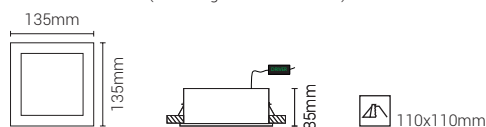

7061 IK03 IP43 Módulo LED		
Código	Fluxo/Pot. (aprox.)	€
7061.113.xOL	12.6W - 1788 lm	59,22

3000K | 4000K

1 2 7 8 9 0





7062



Informação Importante: Driver Remoto Incluído
(não integrado na luminária)

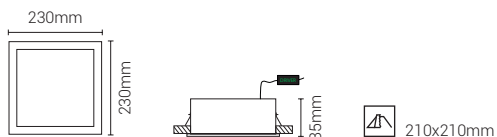

7063



Informação Importante: Driver Remoto Incluído
(não integrado na luminária)

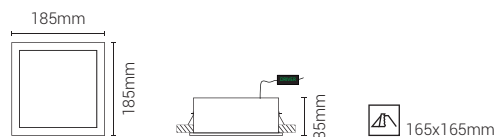

7062 IK03 IP43 E27 Módulo LED		
Código	Fluxo/Pot. (aprox.)	€
7062.200.xFX	(2x) E27	50,86
7062.123.xOL	22.5W - 3073 lm	89,91

3000K | 4000K

1 2 7 8 9 0 F

7063 IK03 IP43 Módulo LED		
Código	Fluxo/Pot. (aprox.)	€
7063.119.xOL	18.8W - 2514 lm	76,62

3000K | 4000K

1 2 7 8 9 0





1010 | 6010

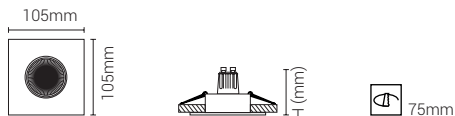

1010 IK02 IP20 GU5.3		6010 IK02 IP20 LED GU10 COB	
Código	H (mm)	Fluxo/Pot. (aprox.)	€
1010.100.xXX	-	GU5.3	19,03
6010.100.xXX	-	GU10	19,99
6010.105.xXL	115	GU10 5W - 380 lm	26,17
6010.060.xXL	90	COB 3W - 600 lm	55,48
6010.110.xXL	90	COB 7W - 1100 lm	55,48

2700K | 3000K | 4000K

1 2 7 8 9

1020 | 6020

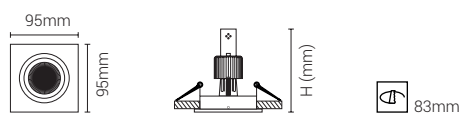

1020 IK03 IP20 GU5.3		6020 IK03 IP20 LED GU10	
Código	H (mm)	Fluxo/Pot. (aprox.)	€
1020.100.xXX	-	GU5.3	12,98
6020.100.xXX	-	GU10	12,98
6020.105.xXL	115	GU10 5W - 380 lm	19,16

2700K | 3000K | 4000K

1 2 7 8 9

1013 | 6013

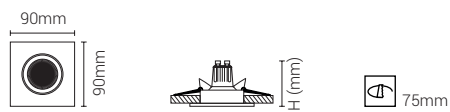

1013 IK05 IP20 GU5.3		6013 IK05 IP20 LED GU10 COB	
Código	H (mm)	Fluxo/Pot. (aprox.)	€
1013.100.xXX	-	GU5.3	34,53
6013.100.xXX	-	GU10	34,53
6013.105.xXL	130	GU10 5W - 380 lm	40,71
6013.060.xXL	105	COB 3W - 600 lm	69,23
6013.110.xXL	105	COB 7W - 1100 lm	69,23

2700K | 3000K | 4000K

1 2 7 8 9

1513

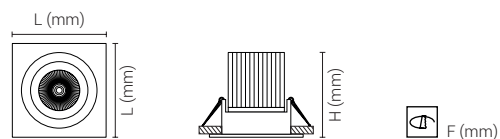

1513 IK03 IP20 COB						
Código	L (mm)	H (mm)	F (mm)	Fluxo/Pot. (aprox.)	HF (€) 1513	DALI (€) 1713
1513.085.1TL	85	73	75	9W - 1200lm	38,61	71,65
1513.100.1TL	100	85	90	12,5W - 2000lm	40,83	73,87
1513.140.1TL	140	105	125	23,6W - 3600lm	51,99	86,70
1513.175.1TL	175	115	160	35,8W - 5000lm	69,08	93,01

2700K | 3000K | 4000K

1 2 7 9 0 T





1014 | 6014

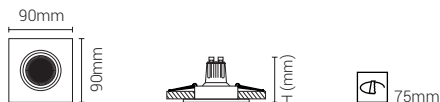

1014 IK03 IP20 GU5.3		6014 IK03 IP20 LED GU10 COB	
Código	H (mm)	Fluxo/Pot. (aprox.)	€
1014.100.xXX	-	GU5.3	41,02
6014.100.xXX	-	GU10	41,02
6014.105.xXL	115	GU10 5W - 380 lm	47,20
6014.060.xXL	90	COB 3W - 600 lm	75,73
6014.110.xXL	90	COB 7W - 1100 lm	75,73

2700K | 3000K | 4000K

1 2 7 8 9

1512

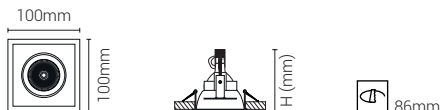

1512 IK02 IP20 - LED GU10 IP54 - COB			
Código	H (mm)	Fluxo/Pot. (aprox.)	€
1512.100.xXX	-	GU10	18,73
1512.105.xXL	130	GU10 5W - 380 lm	23,81
1512.110.xTL	75	COB 9W - 1200 lm	42,84

2700K | 3000K | 4000K

1 2 7 9 0 T

1504

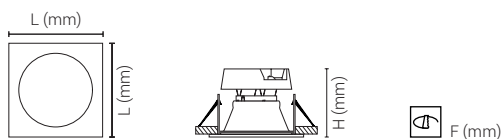

1504 IK03 IP44 LED					
Código	L (mm)	H (mm)	F (mm)	Fluxo/Pot. (aprox.)	€
1504.113.xFL	135	80	115	13W - 1000 lm	51,80
1504.126.xFL	185	90	165	26W - 2000 lm	71,46

2700K | 3000K | 4000K

1 2 7 8 9 0 F

1511



Informação Importante: Driver Remoto Incluído (não integrado na luminária)

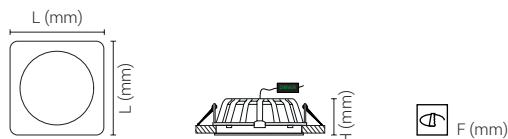

1511 IK03 IP44 LED						
Código	L (mm)	H (mm)	F (mm)	Fluxo/Pot. (aprox.)	HF (€) 1511	DALI (€) 1711
1511.087.xFL	87	40	77	3.1W - 420 lm	37,25	67,51
1511.115.xFL	115	40	102	7.5W - 1000 lm	43,24	74,49
1511.140.xFL	140	45	125	15W - 1650 lm	50,47	83,52
1511.170.xFL	170	45	150	20W - 2500 lm	55,64	90,04
1511.220.xFL	220	45	205	25W - 3000 lm	67,26	101,97

2700K | 3000K | 4000K

1 2 7 9 0 F





7025



Informação Importante: Driver Remoto Incluído
(não integrado na luminária)

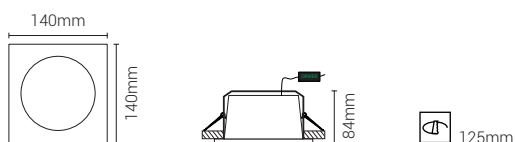

7025 IK03 IP44 LED Module		
Código	Fluxo/Pot. (aprox. 142lm/W)	€
7025.113.x0L	12.6W - 1788 lm	51,99

2700K | 3000K | 4000K

1 2 4 5 7 9 0

7051

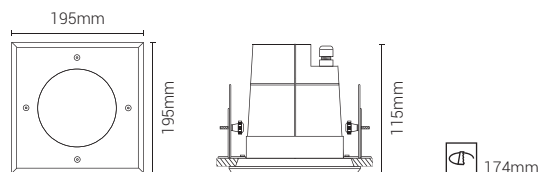

7051 IP65 LED GU10 AR111		
Código	Fluxo/Pot. (aprox.)	€
7051.115.xxL	15W - 1120 lm	181,07

2700K | 3000K | 4000K

1 2 7 8 9 F T

1028 | 6028

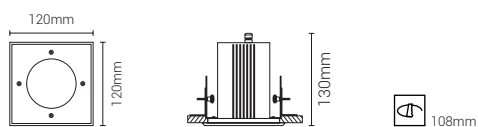

1028 IK08 IP65 GU5.3 12V		6028 IK08 IP65 LED GU10	
Código	Fluxo/Pot. (aprox.)	€	
1028.100.xxX	GU5.3	65,53	
6028.100.xxX	GU10	65,74	
6028.105.xxL	GU10 5W - 380 lm	71,93	

2700K | 3000K | 4000K

1 2 7 8 9 F T

4091

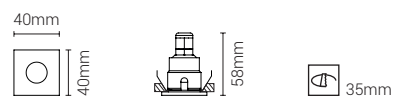

4091 IK03 IP65 LED		
Código	Fluxo/Pot. (aprox.)	€
4091.112.xTL	1W - 140 lm	26,92
4091.112.8TL	1W - 140 lm	25,69
0101.103.XXX +	Driver LED 3W 350 mA	7,72
9090.000.XXX	Caixa	4,12

2700K | 3000K | 4000K | 5000K | 6500K

1 2 7 8 9 T

*Outras opções na página 243.
Driver LED não incluído.
A versão pintada é em alumínio.





6080.100



6080.100 | IK02 | IP20 | LED GU10

Código	H (mm)	Fluxo/Pot. (aprox.)	€
6080.100.xXX	-	GU10	19,72
6080.105.xXL	120	GU10 5W - 380 lm	25,91

2700K | 3000K | 4000K

1 2 7 9

6080.200

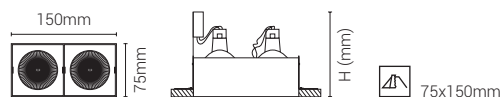

6080.200 | IK02 | IP20 | LED GU10

Código	H (mm)	Fluxo/Pot. (aprox.)	€
6080.200.xXX	-	(2x) GU10	32,86
6080.205.xXL	120	GU10 (2x) 5W - 380 lm	45,22

2700K | 3000K | 4000K

1 2 7 9

6080.300

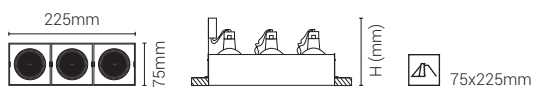

6080.300 | IK02 | IP20 | LED GU10

Código	H (mm)	Fluxo/Pot. (aprox.)	€
6080.300.xXX	-	(3x) GU10	49,52
6080.305.xXL	120	GU10 (3x) 5W - 380 lm	68,06

2700K | 3000K | 4000K

1 2 7 9

6080.400

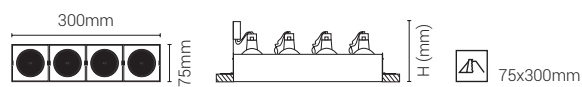

6080.400 | IK02 | IP20 | LED GU10

Código	H (mm)	Fluxo/Pot. (aprox.)	€
6080.400.xXX	-	(4x) GU10	63,09
6080.405.xXL	120	GU10 (4x) 5W - 380 lm	87,81

2700K | 3000K | 4000K

1 2 7 9

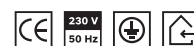
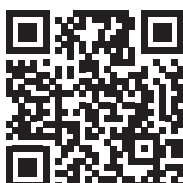



6037.100

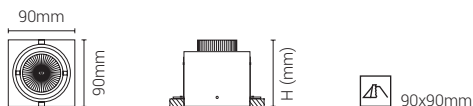

6037.100 | IK02 | IP20 | LED GU10 | COB

Código	H (mm)	Fluxo/Pot. (aprox.)	€
6037.100.xXX	-	GU10	33,66
6037.105.xXL	80	GU10 5W - 380 lm	39,84
6037.060.xXL	93	COB 3W - 600 lm	71,40
6037.110.xXL	93	COB 7W - 1100 lm	71,40

2700K | 3000K | 4000K

1 2 7 9

6037.200

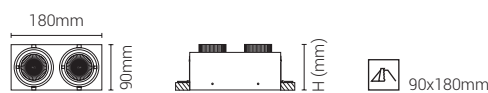
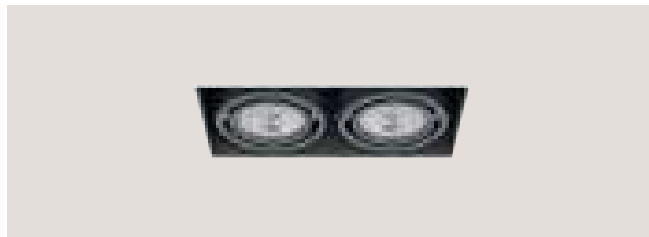

6037.200 | IK02 | IP20 | LED GU10 | COB

Código	H (mm)	Fluxo/Pot. (aprox.)	€
6037.200.xXX	-	(2x) GU10	55,76
6037.205.xXL	80	GU10 (2x) 5W - 380 lm	68,12
6037.120.xXL	93	COB (2x) 3W - 600 lm	131,73
6037.220.xXL	93	COB (2x) 7W - 1100 lm	131,73

2700K | 3000K | 4000K

1 2 7 9

6037.300

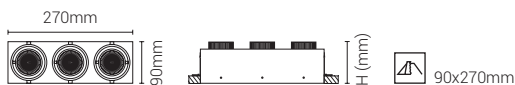
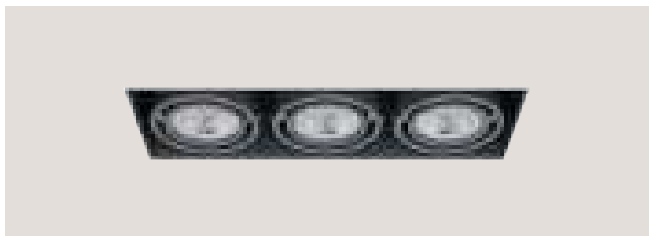

6037.300 | IK02 | IP20 | LED GU10 | COB

Código	H (mm)	Fluxo/Pot. (aprox.)	€
6037.300.xXX	-	(3x) GU10	79,44
6037.305.xXL	80	GU10 (3x) 5W - 380 lm	97,98
6037.180.xXL	93	COB (3x) 3W - 600 lm	193,40
6037.330.xXL	93	COB (3x) 7W - 1100 lm	193,40

2700K | 3000K | 4000K

1 2 7 9

6037.400

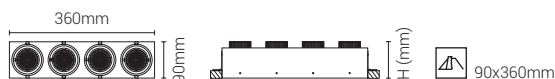

6037.400 | IK02 | IP20 | LED GU10 | COB

Código	H (mm)	Fluxo/Pot. (aprox.)	€
6037.400.xXX	-	(4x) GU10	99,74
6037.405.xXL	80	GU10 (4x) 5W - 380 lm	124,47
6037.240.xXL	93	COB (4x) 3W - 600 lm	251,69
6037.440.xXL	93	COB (4x) 7W - 1100 lm	251,69

2700K | 3000K | 4000K

1 2 7 9

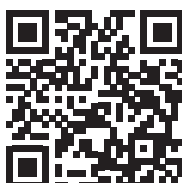



1098.100 | 6198.100

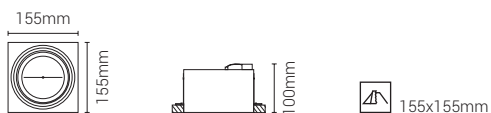

1098.100 | IK02 | IP20 | G53 6198.100 | IK02 | IP20 | LED GU10

Código	Fluxo/Pot. (aprox.)	€
1098.100.xXX	G53	34,04
6198.100.xXX	GU10	34,04
6198.116.xXL	15W - 1120 lm	51,49

2700K | 3000K | 4000K

1 2 7 9

1098.200 | 6198.200



1098.200 | IK02 | IP20 | G53 6198.200 | IK02 | IP20 | LED GU10

Código	Fluxo/Pot. (aprox.)	€
1098.200.xXX	(2x) G53	59,63
6198.200.xXX	(2x) GU10	59,63
6198.216.xXL	(2x) 15W - 1120 lm	95,01

2700K | 3000K | 4000K

1 2 7 9

1098.300 | 6198.300

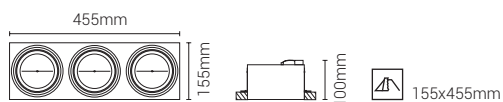

1098.300 | IK02 | IP20 | G53 6198.300 | IK02 | IP20 | LED GU10

Código	Fluxo/Pot. (aprox.)	€
1098.300.xXX	(3x) G53	85,94
6198.300.xXX	(3x) GU10	85,94
6198.316.xXL	(3x) 15W - 1120 lm	139,20

2700K | 3000K | 4000K

1 2 7 9

1098.400 | 6198.400

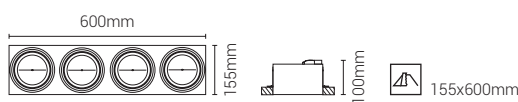

1098.400 | IK02 | IP20 | G53 6198.400 | IK02 | IP20 | LED GU10

Código	Fluxo/Pot. (aprox.)	€
1098.400.xXX	(4x) G53	114,25
6198.400.xXX	(4x) GU10	114,25
6198.416.xXL	(4x) 15W - 1120 lm	185,29

2700K | 3000K | 4000K

1 2 7 9





Focos Salientes de Teto

Luminária saliente, projeção de luz descendente



1524.100 Pg. 164



1524.200 Pg. 164



1524.300 Pg. 164

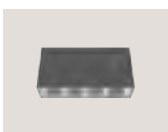

1524.400 Pg. 164



1524.500 Pg. 165



1525.400 Pg. 165



1525.900 Pg. 165



6098.100 Pg. 166



6098.200 Pg. 166



6098.300 Pg. 166



6097.100 Pg. 167



6097.200 Pg. 167



6097.300 Pg. 167



6091 Pg. 168



6092 Pg. 168



6512 Pg. 168



7092 Pg. 169



7089 Pg. 169



6093 Pg. 170



6094 Pg. 170



6595 Pg. 170



6502 Pg. 170



7085 Pg. 171



7099 Pg. 171



7088 Pg. 171



7087 Pg. 171



7095 Pg. 172



7595 Pg. 172



7596 Pg. 172



7096 Pg. 172



1199.100 Pg. 173



1199.200 Pg. 173



1199.300 Pg. 173



1199.400 Pg. 173



1524.100



Informação Importante: Driver Remoto Incluído
(não integrado na luminária)

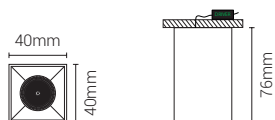

1524.100 IK03 IP20 LED		
Código	Fluxo/Pot. (aprox.)	€
1524.101.xXL	1W - 140 lm	42,19

2700K | 3000K | 4000K

1 2 7 9 0

1524.200

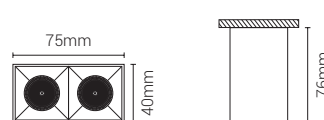
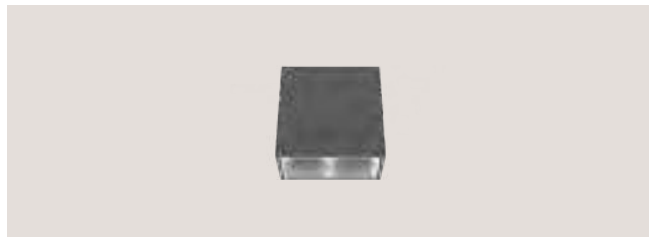

1524.200 IK03 IP20 LED		
Código	Fluxo/Pot. (aprox.)	€
1524.201.xXL	2W - 280 lm	55,45

2700K | 3000K | 4000K

1 2 7 9 0

1524.300



1524.300 IK03 IP20 LED		
Código	Fluxo/Pot. (aprox.)	€
1524.301.xXL	4.7W - 450 lm	73,47

2700K | 3000K | 4000K

1 2 7 9 0

1524.400

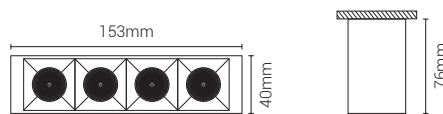
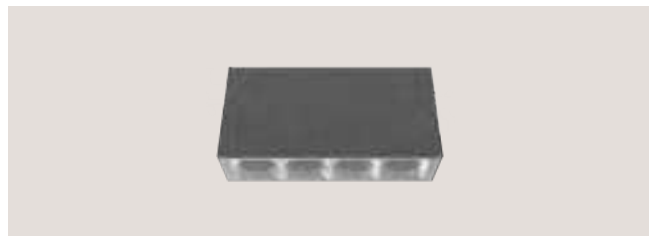

1524.400 IK03 IP20 LED		
Código	Fluxo/Pot. (aprox.)	€
1524.401.xXL	6W - 600 lm	82,93

2700K | 3000K | 4000K

1 2 7 9 0





1524.500

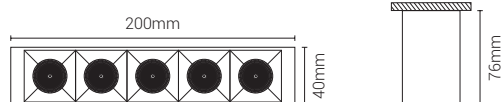

1524.500 | IK03 | IP20 | LED

Código	Fluxo/Pot. (aprox.)	€
1524.501.xXL	7W - 750 lm	94,52

2700K | 3000K | 4000K

1 2 7 9 0

1525.400

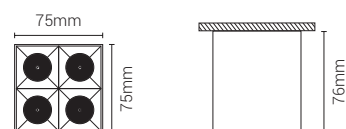

1525.400 | IK03 | IP20 | LED

Código	Fluxo/Pot. (aprox.)	€
1525.401.xXL	6W - 600 lm	90,35

2700K | 3000K | 4000K

1 2 7 9 0

1525.900

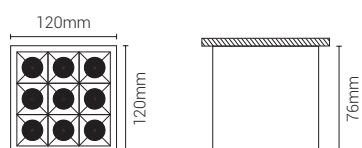

1525.900 | IK03 | IP20 | LED

Código	Fluxo/Pot. (aprox.)	€
1525.901.xXL	12W - 1350 lm	133,09

2700K | 3000K | 4000K

1 2 7 9 0

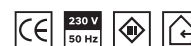



6098.100



6098.100 IK02 IP20 LED GU10		
Código	Fluxo/Pot. (aprox.)	€
6098.100.xXX	GU10	52,85
6098.100.8XX	GU10	62,34
6098.105.xXL	5W - 380 lm	59,04
6098.105.8XL	5W - 380 lm	68,53

2700K | 3000K | 4000K

1 2 7 8 9

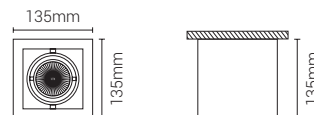

6098.200



6098.200 IK02 IP20 LED GU10		
Código	Fluxo/Pot. (aprox.)	€
6098.200.xXX	GU10	89,45
6098.200.8XX	GU10	93,07
6098.205.xXL	(2x) 5W - 380 lm	101,81
6098.205.8XL	(2x) 5W - 380 lm	105,43

2700K | 3000K | 4000K

1 2 7 8 9

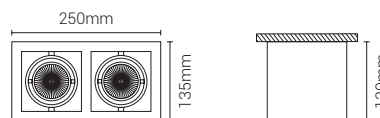

6098.300



6098.300 IK02 IP20 LED GU10		
Código	Fluxo/Pot. (aprox.)	€
6098.300.xXX	GU10	124,29
6098.300.8XX	GU10	128,40
6098.305.xXL	(3x) 5W - 380 lm	142,83
6098.305.8XL	(3x) 5W - 380 lm	146,94

2700K | 3000K | 4000K

1 2 7 8 9

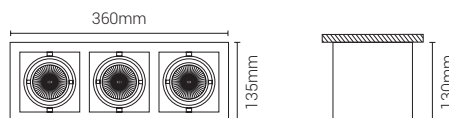



6097.100



6097.100 | IK02 | IP20 | LED GU10 AR111

Código	Fluxo/Pot. (aprox.)	€
6097.100.xXX	GU10 AR111	64,54
6097.115.xXL	15W - 1120 lm	83,88

2700K | 3000K | 4000K

1 2 7 8 9



6097.200



6097.200 | IK02 | IP20 | LED GU10 AR111

Código	Fluxo/Pot. (aprox.)	€
6097.200.xXX	GU10 AR111	102,31
6097.215.xXL	(2x) 15W - 1120 lm	141,00

2700K | 3000K | 4000K

1 2 7 8 9



6097.300



6097.300 | IK02 | IP20 | LED GU10 AR111

Código	Fluxo/Pot. (aprox.)	€
6097.300.xXX	GU10 AR111	141,01
6097.315.xXL	(3x) 15W - 1120 lm	199,04

2700K | 3000K | 4000K

1 2 7 8 9

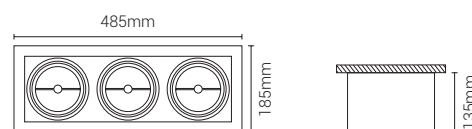



6091

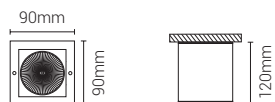

6092

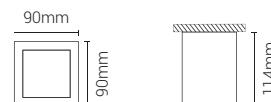

6091 | IK06 | IP43 | LED GU10

Código	Fluxo/Pot. (aprox.)	€
6091.100.xxX	GU10	37,96
6091.105.xxL	5W - 380 lm	44,14

2700K | 3000K | 4000K



6092 | IK06 | IP43 | LED GU10

Código	Fluxo/Pot. (aprox.)	€
6092.100.xxX	GU10	34,06
6092.105.xxL	5W - 380 lm	40,24

2700K | 3000K | 4000K



6512

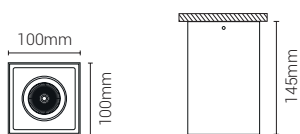

6512 | IK03 | IP20 - LED GU10 | IP54 - COB

Código	Fluxo/Pot. (aprox.)	€
6512.100.xXX	GU10	70,50
6512.105.xXL	GU10 5W - 380 lm	82,90
6512.110.xTL	COB 9W - 1200 lm	88,49

2700K | 3000K | 4000K

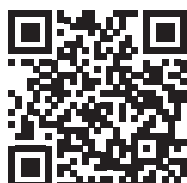
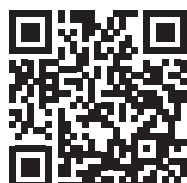



7092

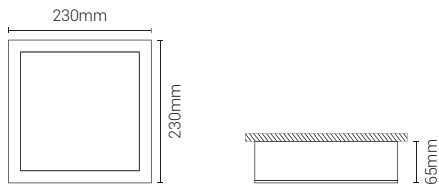

7089

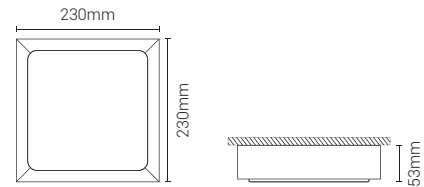
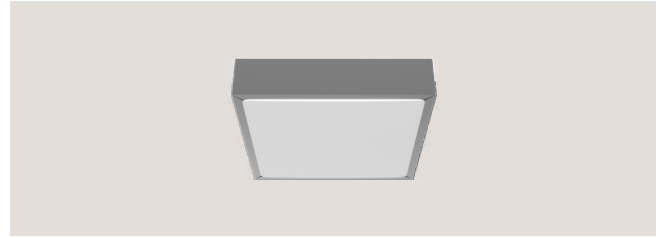

7092 | IK07 | IP43 | E27 | Módulo LED

Código	Fluxo/Pot. (aprox.)	€
7092.200.xFX	(2x) E27	65,61
7092.123.xOL	22.5W - 3073 lm	103,36

2700K | 3000K | 4000K

1 2 4 7 8 9 0 F

7089 | IK08 | IP54 | Módulo LED

Código	Fluxo/Pot. (aprox. 116 lm/W)	€
7089.113.xOL	13W - 1500 lm	115,11

2700K | 3000K | 4000K

1 2 7 8 9 0





6093



6093 | IK02 | IP20 | LED GU10

Código	Fluxo/Pot. (aprox.)	€
6093.100.xXX	GU10	29,87
6093.105.xXL	5W - 380 lm	35,88

2700K | 3000K | 4000K

1 2 7 9

6094

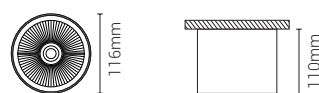

6094 | IK02 | IP20 | LED GU10 AR111

Código	Fluxo/Pot. (aprox.)	€
6094.100.xXX	GU10 AR111	36,04
6094.115.xXL	15W - 1120 lm	55,39

2700K | 3000K | 4000K

1 2 7 9

6595

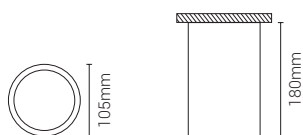

6595 | IK03 | IP40 | E27

Código	Fluxo/Pot. (aprox.)	€
6595.100.xFX	E27	58,39
6595.109.xFL	9.5W - 875 lm	86,55

3000K | 4000K

1 2 F

6502

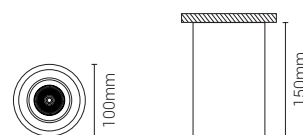

6502 | IK03 | IP20 - LED GU10 | IP54 - COB

Código	Fluxo/Pot. (aprox.)	€
6502.100.xXX	GU10	67,44
6502.105.xXL	GU10 5W - 380 lm	82,90
6502.110.xTL	COB 10W - 1200 lm	81,52

2700K | 3000K | 4000K

1 2 7 9 T

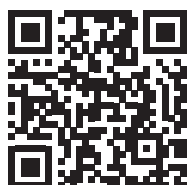



7085

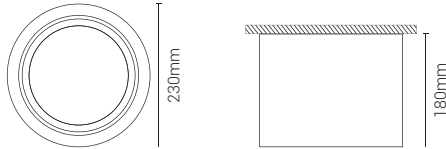
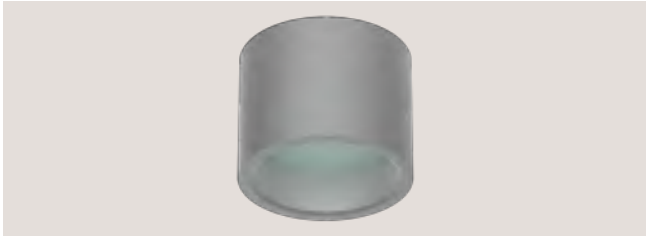

7085 | IK03 | IP20 | Módulo LED

Código	Fluxo/Pot. (aprox. 134lm/W)	HF (€) 7085	DALI (€) 7285
7085.118.xFL	18.8W - 2514 lm	110,35	145,06

3000K | 4000K

1 2 7 9 F

7099

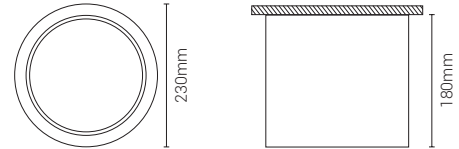

7099 | IK03 | IP40 | Módulo LED

Código	Fluxo/Pot. (aprox. 134lm/W)	HF (€) 7099	DALI (€) 7299
7099.118.xFL	18.8W - 2514 lm	110,35	145,06

3000K | 4000K

1 2 7 9 F

7088

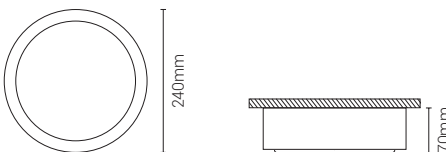

7088 | IK10 | IP54 | Módulo LED

Código	Fluxo/Pot. (aprox. 122lm/W)	€
7088.113.xOL	13W - 1500 lm	88,43
7088.113.4OL	13W - 1500 lm	107,44

3000K | 4000K

1 2 4 7 9 0

7087

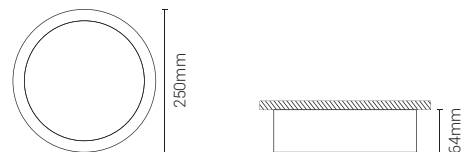

7087 | IK03 | IP43 | Módulo LED

Código	Fluxo/Pot. (aprox.)	€
7087.2xx.xOL	13W - 1500 lm	88,86
7087.2xx.4OL	13W - 1500 lm	108,58

3000K | 4000K

1 2 4 7 9 0





7095

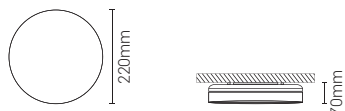

7095 IK10 IP54 Módulo LED		
Código	Fluxo/Pot. (aprox.)	€
7095.116.10L	13W - 1500 lm	62,78

3000K | 4000K



7595

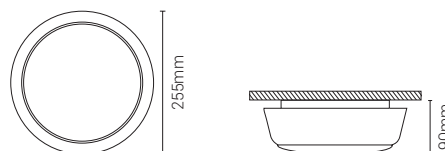

7595 IK07 IP44 LED		
Código	Fluxo/Pot. (aprox.)	€
7595.112.10L	12W - 1200 lm	27,82

4000K



7596

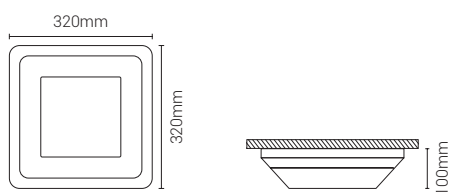

7596 IK06 IP44 LED		
Código	Fluxo/Pot. (aprox.)	€
7596.112.10L	12W - 1200 lm	33,97

4000K



7096



7096 IK08 IP54 Módulo LED		
Código	Fluxo/Pot. (aprox. 116lm/W)	€
7096.209.10L	13W - 1500 lm	77,61

2700K | 3000K | 4000K

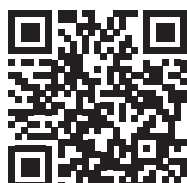

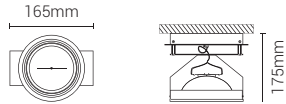

1199.100

1199.100 | IK04 | IP20 | LED G53 12V

Código	Fluxo/Pot. (aprox.)	€
1199.110.xXL	10W - 570 lm	87,20
1199.115.xXL	15W - 830 lm	90,12

2700K | 3000K | 4000K

1 2 7 9

1199.200

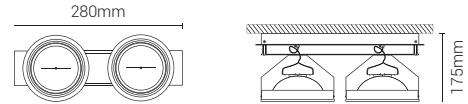
1199.200 | IK04 | IP20 | LED G53 12V

Código	Fluxo/Pot. (aprox.)	€
1199.210.xXL	(2x) 10W - 570 lm	159,20
1199.215.xXL	(2x) 15W - 830 lm	165,04

2700K | 3000K | 4000K

1 2 7 9

1199.300

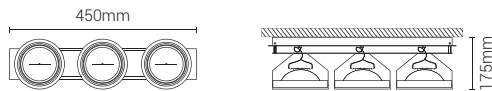
1199.300 | IK04 | IP20 | LED G53 12V

Código	Fluxo/Pot. (aprox.)	€
1199.310.xXL	(3x) 10W - 570 lm	231,62
1199.315.xXL	(3x) 15W - 830 lm	240,39

2700K | 3000K | 4000K

1 2 7 9

1199.400

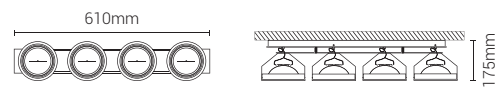
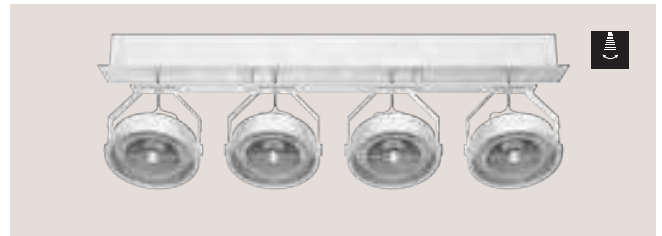
1199.400 | IK04 | IP20 | LED G53 12V

Código	Fluxo/Pot. (aprox.)	€
1199.410.xXL	(4x) 10W - 570 lm	309,15
1199.415.xXL	(4x) 15W - 830 lm	320,84

2700K | 3000K | 4000K

1 2 7 9





Apliques de Parede

▶ **Luminária de encastrar, projeção de luz frontal**

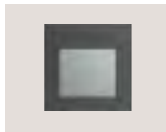

4077 Pg. 176



4078 Pg. 176

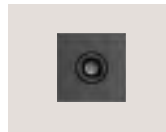

4091 Pg. 177



4092 Pg. 177

▶ **Luminária saliente, projeção de luz ascendente**



4002 Pg. 178

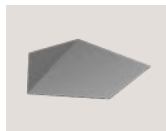

4006 Pg. 178

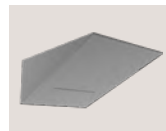

4007 Pg. 178

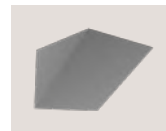

4008 Pg. 178



4005 Pg. 179

▶ **Luminária saliente, projeção de luz descendente e ascendente**



4004 Pg. 179



4009 Pg. 179



2040 Pg. 179

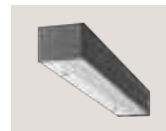

4001 Pg. 180



4077

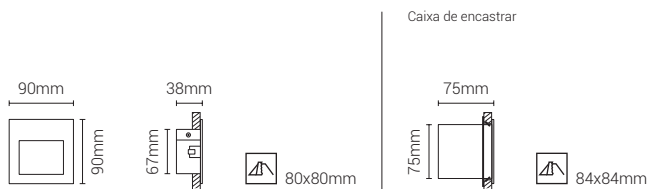
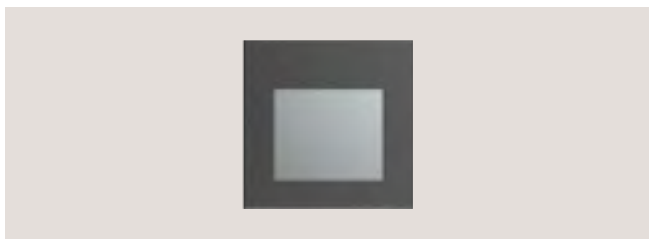

4077 | IK05 | IP43 | LED 12V

Código	Fluxo/Pot. (aprox.)	€
4077.103.xFL	3W - 285 lm	28,96
4077.105.xFL	5W - 570 lm	28,96
4177.103.xFL	3W - 285 lm	39,07
4177.105.xFL	5W - 570 lm	39,07
9963.000.XXX	Caixa	5,41

2700K | 3000K | 4000K | 5000K | 6500K

1 2 7 8 9 F

4177 - Driver LED incluído

4078

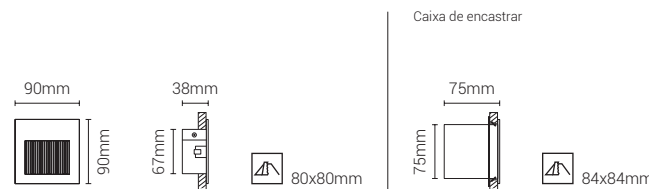

4078 | IK05 | IP20 | LED 12V

Código	Fluxo/Pot. (aprox.)	€
4078.103.xXL	3W - 285 lm	26,93
4078.105.xXL	5W - 570 lm	26,93
4178.103.xXL	3W - 285 lm	36,94
4178.105.xXL	5W - 570 lm	36,94
9963.000.XXX	Caixa	5,41

2700K | 3000K | 4000K | 5000K | 6500K

1 2 7 8 9

4178 - Driver LED incluído





4091

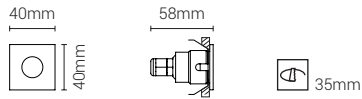
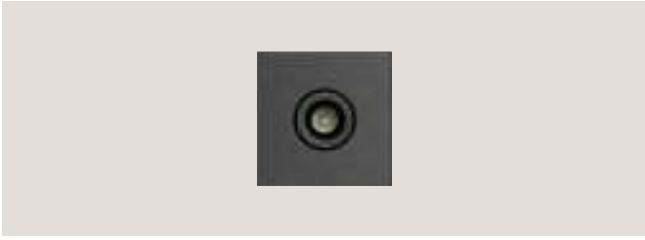

4092

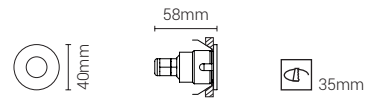

4091 | IK03 | IP65 | LED

Código	Fluxo/Pot. (aprox.)	€
4091.112.xTL	1W - 140 lm	26,92
4091.112.8TL	1W - 140 lm	25,69
0101.103.XXX *	Driver LED 3W 350 mA	7,72
9090.000.XXX	Caixa	4,12

2700K | 3000K | 4000K | 5000K | 6500K

1 2 7 8 9 T

*Outras opções na página 243.
Driver LED não incluído.
A versão pintada é em alumínio.

4092 | IK03 | IP65 | LED

Código	Fluxo/Pot. (aprox.)	€
4092.112.xTL	1W - 140 lm	26,21
4092.112.8TL	1W - 140 lm	24,97
0101.103.XXX *	Driver LED 3W 350 mA	7,72
9090.000.XXX	Caixa	4,12

2700K | 3000K | 4000K | 5000K | 6500K

1 2 7 8 9 T

*Outras opções na página 243.
Driver LED não incluído.
A versão pintada é em alumínio.





4002

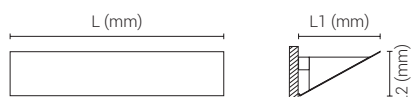
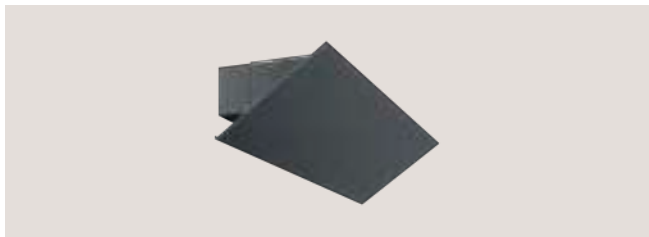

4002 IK04 IP20 Módulo LED						
Código	L (mm)	L1 (mm)	L2 (mm)	Fluxo/Pot. (aprox. 183lm/W)	HF (€) 4002	DALI (€) 4202
4002.204.xOL	300	180	110	1300 lm	99,28	-
4002.204.8OL	300	180	110	1300 lm	102,53	-
4002.104.xOL	250	115	74	650 lm	64,04	-
4002.104.8OL	250	115	74	650 lm	67,13	-
4002.207.xOL	500	240	110	2600 lm	120,14	-
4002.207.8OL	500	240	110	2600 lm	124,25	-
4002.114.xOL	700	180	110	2600 lm	128,12	156,00
4002.114.8OL	700	180	110	2600 lm	145,67	173,55
4002.214.xOL	700	240	110	5200 lm	146,05	161,59
4002.214.8OL	700	240	110	5200 lm	163,60	179,15
4002.407.xOL	1230	180	110	5200 lm	187,22	202,76
4002.407.8OL	1230	180	110	5200 lm	193,40	208,95

2700K | 3000K | 4000K | 5000K | 6500K

1 2 7 8 9 0

4006

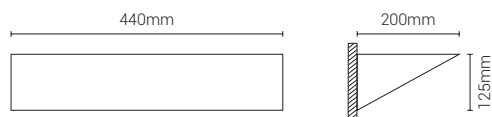
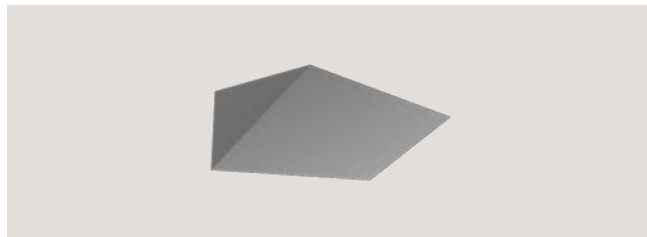

4006 IK04 IP20 Módulo LED		
Código	Fluxo/Pot. (aprox. 183lm/W)	€
4006.207.xOL	2600 lm	104,41
4006.207.8OL	2600 lm	120,82

2700K | 3000K | 4000K | 5000K | 6500K

1 2 7 8 9 0

4007

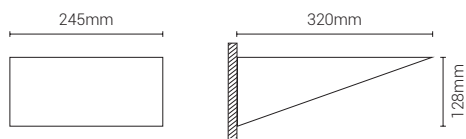
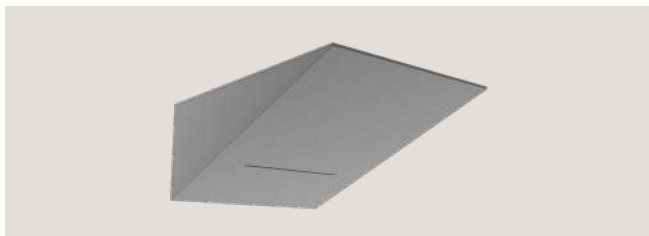

4007 IK04 IP20 Módulo LED		
Código	Fluxo/Pot. (aprox. 183lm/W)	€
4007.204.xOL	1300 lm	94,33
4007.204.8OL	1300 lm	101,51

2700K | 3000K | 4000K | 5000K | 6500K

1 2 7 8 9 0

4008

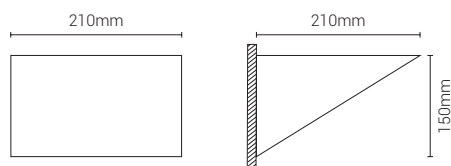
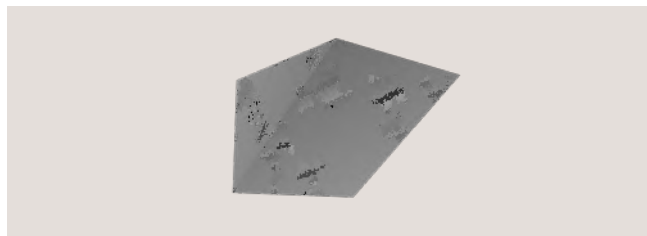

4008 IK04 IP20 Módulo LED		
Código	Fluxo/Pot. (aprox. 183lm/W)	€
4008.204.xOL	1300 lm	82,84
4008.204.8OL	1300 lm	87,60

2700K | 3000K | 4000K | 5000K | 6500K

1 2 7 8 9 0

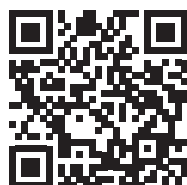



4005

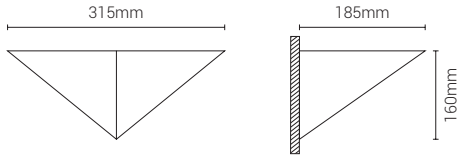
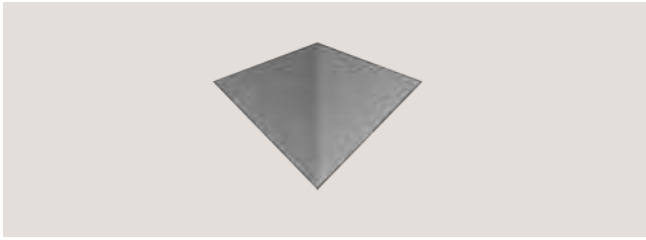

4005 IP20 Módulo LED			
Código	Fluxo/Pot. (aprox. 183lm/W)	€	
4005.204.xOL	1300 lm	73,50	
4005.204.8OL	1300 lm	76,59	

2700K | 3000K | 4000K | 5000K | 6500K

1 2 7 8 9 0

4004

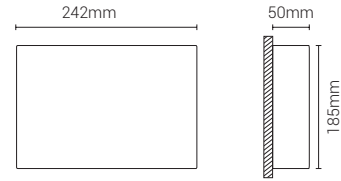
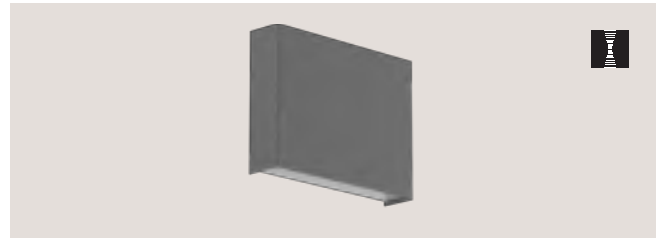

4004 IK03 IP20 Módulo LED			
Código	Fluxo/Pot. (aprox. 183lm/W)	€	
4004.204.xOL	1300 lm	113,75	

2700K | 3000K | 4000K | 5000K | 6500K

1 2 7 8 9 0

4009

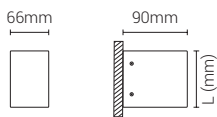

4009 IK05 IP20 LED GU10			
Código	L (mm)	Fluxo/Pot. (aprox.)	€
4009.102.xFL	105	25W - 250 lm	42,45
4009.200.xFL	195	GU10	39,25
4009.205.xXX	195	(2x) 5W - 380 lm	51,62

2700K | 3000K | 4000K | 5000K | 6500K

1 2 7 8 9 F

2040

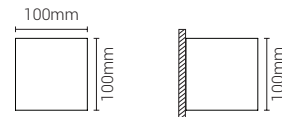
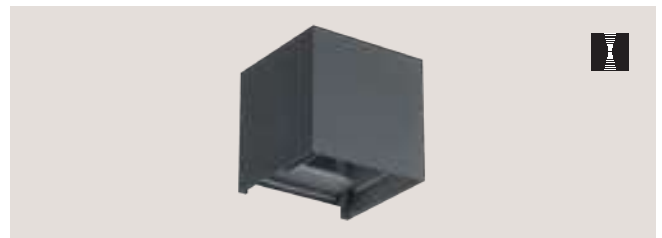

2040 IP65 COB			
Código	Fluxo/Pot. (aprox.)	€	
2040.107.xTL	7W - 560 lm	33,41	

3000K | 4000K

1 2 7 9 T

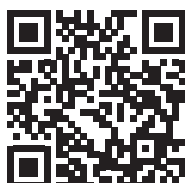
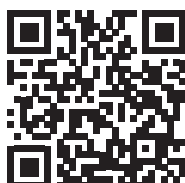



4001



4001 IK04 IP20 Módulo LED				
Código	L (mm)	Fluxo/Pot. (aprox. 183lm/W)	HF (€) 4001	DALI (€) 4201
4001.204.xOL	235	1300 lm	82,06	-
4001.204.8OL	235	1300 lm	83,33	-
4001.407.xOL	600	5200 lm	113,99	129,54
4001.407.8OL	600	5200 lm	115,04	130,59
4001.607.xOL	900	7800 lm	151,52	167,06
4001.607.8OL	900	7800 lm	154,61	170,15

2700K | 3000K | 4000K | 5000K | 6500K

1 2 7 8 9 C W O

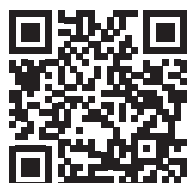

EXTERIOR





Índice Fotográfico

Teto Encastrar

Luminária encastrada com aba de remate, projeção de luz descendente



6023 Pg. 183



6024 Pg. 183



1027 | 6027 Pg. 183



7041 Pg. 183



1028 | 6028 Pg. 184



7051 Pg. 184

Teto Saliente

Luminária saliente, projeção de luz descendente



2560 Pg. 185



2057 Pg. 185



2058 Pg. 185



2059 Pg. 185



2060 Pg. 186



2061 Pg. 186



2062 Pg. 186



2561 Pg. 187



2562 Pg. 187



2080 Pg. 187



2083 Pg. 187



6023

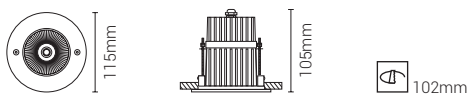
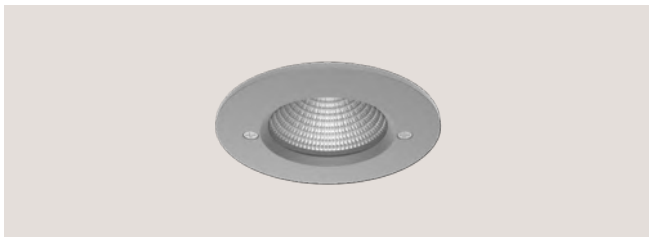

6023 IP65 COB		
Código	Fluxo/Pot. (aprox.)	€
6023.109.xxL	9W - 710 lm	98,77
6023.109.8xL	9W - 710 lm	94,18

3000K | 4000K

1 2 7 8 9 F T

6024

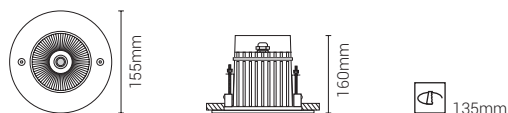



6024 IP67 COB		
Código	Fluxo/Pot. (aprox.)	€
6024.112.xPL	12.8W - 1206 lm	119,64
6024.112.8PL	12.8W - 1206 lm	121,82

2700K | 3000K | 4000K

1 2 7 8 9 P

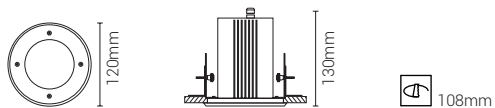
1027 | 6027



1027 IK08 IP65 GU5.3  			6027 IK08 IP65 LED GU10		
Código	Fluxo/Pot. (aprox.)	€	Código	Fluxo/Pot. (aprox.)	€
1027.100.xxX	GU5.3	56,13	6027.100.xxX	GU10	56,35
6027.105.xxL	GU10 5W - 380 lm	62,53			

2700K | 3000K | 4000K

1 2 7 8 9 F T

7041

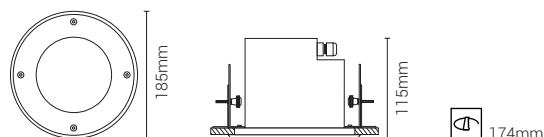

7041 IP65 GU10 AR111		
Código	Fluxo/Pot. (aprox.)	€
7041.115.xxL	15W - 1120 lm	177,51

2700K | 3000K | 4000K

1 2 7 8 9 F T





1028 | 6028

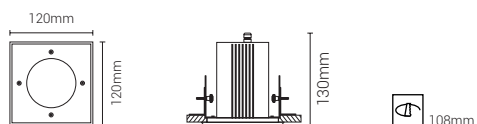

1028 | IK08 | IP65 | GU5.3 **6028 | IK08 | IP65 | LED GU10**

Código	Fluxo/Pot. (aprox.)	€
1028.100.xxX	GU5.3	65,53
6028.100.xxX	GU10	65,74
6028.105.xxL	GU10 5W - 380 lm	71,93

2700K | 3000K | 4000K

[1](#) [2](#) [7](#) [8](#) [9](#) [F](#) [T](#)

7051

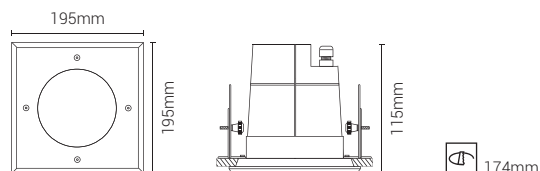

7051 | IP65 | LED GU10 AR111

Código	Fluxo/Pot. (aprox.)	€
7051.115.xxL	15W - 1120 lm	181,07

2700K | 3000K | 4000K

[1](#) [2](#) [7](#) [8](#) [9](#) [F](#) [T](#)

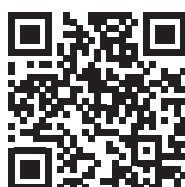



2560

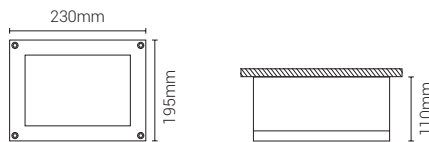
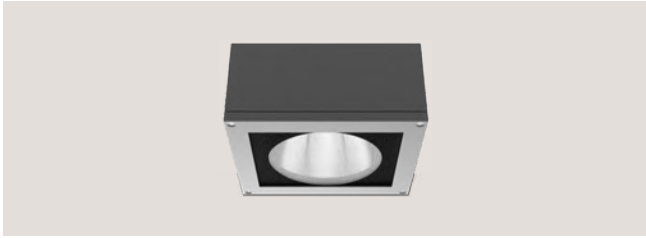

2560 | IK06 | IP54 | LED

Código	Flujo/Pot. (aprox.)	€
2560.122.xPL	22W - 1920 lm	151,64

3000K | 4000K



2057

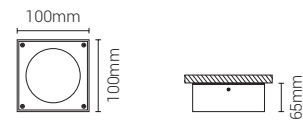
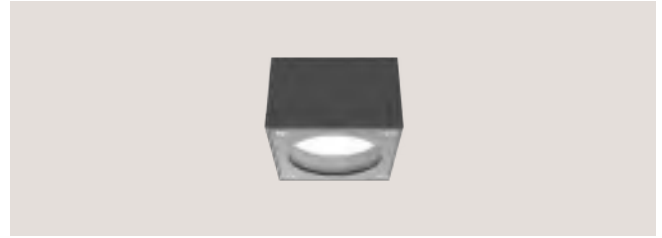

2057 | IK06 | IP54 | LED GX53

Código	Flujo/Pot. (aprox.)	€
2057.107.xTL	6.5W - 650 lm	63,82
2057.107.8TL	6.5W - 650 lm	77,20

3000K | 4000K



2058

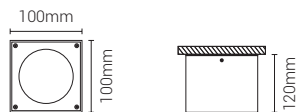
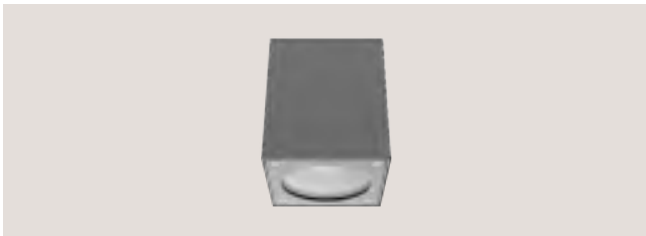

2058 | IK06 | IP54 | LED GU10

Código	Flujo/Pot. (aprox.)	€
2058.100.xTX	GU10	51,25
2058.100.8TX	GU10	90,75
2058.105.xTL	5W - 380 lm	57,43
2058.105.8TL	5W - 380 lm	96,93

2700K | 3000K | 4000K



2059

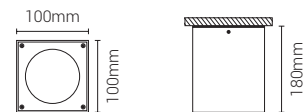

2059 | IK06 | IP54 | E27

Código	Flujo/Pot. (aprox.)	€
2059.100.xFX	E27	54,71
2059.100.8FX	E27	73,19

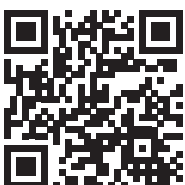



2060

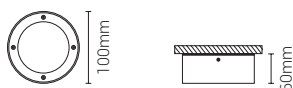

2060 | IK06 | IP54 | LED GX53

Código	Fluxo/Pot. (aprox.)	€
2060.107.xTL	6.5W - 650 lm	74,67
2060.107.8TL	6.5W - 650 lm	91,05

3000K | 4000K

1 2 7 8 9 T

2061

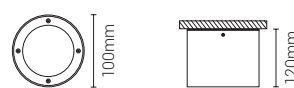

2061 | IK06 | IP54 | LED GU10

Código	Fluxo/Pot. (aprox.)	€
2061.100.xTX	GU10	69,21
2061.100.8TX	GU10	88,55
2061.105.xTL	5W - 380 lm	75,39
2061.105.8TL	5W - 380 lm	94,74

2700K | 3000K | 4000K

1 2 7 8 9 T

2062

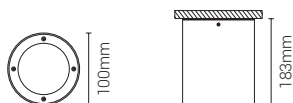

2062 | IK06 | IP54 | E27

Código	Fluxo/Pot. (aprox.)	€
2062.100.xFX	E27	67,54
2062.100.8FX	E27	77,80

1 2 7 8 9 F





2561

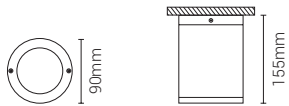

2561 | IK08 | IP54 | LED

Código	Fluxo/Pot. (aprox.)	€
2561.109.xPL	9W - 760 lm	79,27

3000K | 4000K



2562

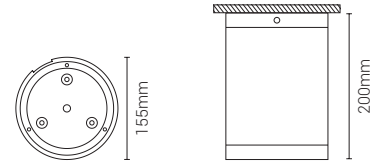

2562 | IK08 | IP65 | LED

Código	Flow/Power (aprox.)	€
2562.122.xPL	22W - 2000 lm	170,18

3000K | 4000K



2080

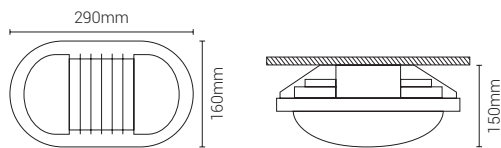

2080 | IK06 | IP44 | LED

Código	Fluxo/Pot. (aprox.)	€
2080.109.xFL	9W - 1250 lm	32,45

3000K | 4000K



2083

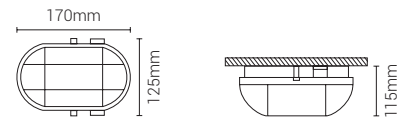

2083 | IK06 | IP54 | LED E27

Código	Fluxo/Pot. (aprox.)	€
2083.105.1TL	5W - 580 lm	12,36

3000K | 4000K





Encastrar de Parede

Luminária de encastrar com aba de remate, projeção de luz frontal



3091 Pg. 190



3093 Pg. 190



3096 Pg. 190



3018 Pg. 191



3095 Pg. 191



2527 Pg. 191



2525 Pg. 191



3092 Pg. 192

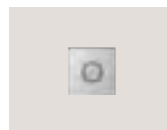

3094 Pg. 192

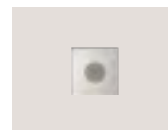

3097 Pg. 192

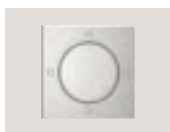

3019 Pg. 193

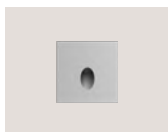

2528 Pg. 193



2526 Pg. 193



2019 Pg. 193



2001 Pg. 194



2002 Pg. 194



2011 Pg. 194



2009 Pg. 194



2010 Pg. 195



2014 Pg. 195

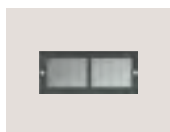

2012 Pg. 195



2013 Pg. 195



2015 Pg. 196



2018 Pg. 196



2016 Pg. 196



2516 Pg. 196



3063 Pg. 197



3064 Pg. 197



2017 Pg. 197



2517 Pg. 197



2522 Pg. 198



2523 Pg. 198



2524 Pg. 198

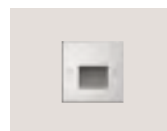

2005.101 Pg. 199



2005.102 Pg. 199



2005.103 Pg. 199



3091

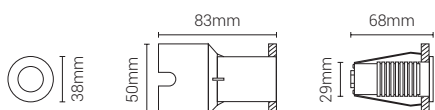
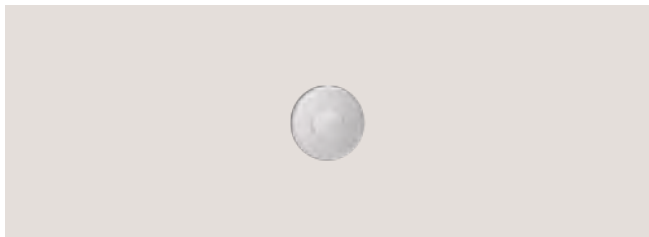

3091 IK06 IP67 LED		
Código	Fluxo/Pot. (aprox.)	€
3091.102.8FL	1.8W - 35 lm	41,99

3000K | 4000K

8 F

Caixa incluída.

3093

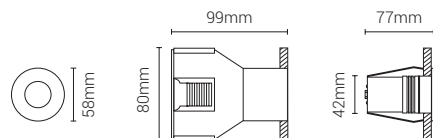

3093 IK08 IP67 LED		
Código	Fluxo/Pot. (aprox.)	€
3093.103.8TL	2.8W - 150 lm	39,98

3000K | 4000K

8 T

Caixa incluída.

3096

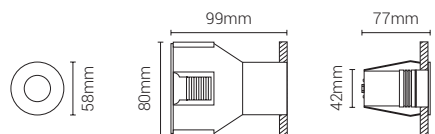

3096 IK08 IP67 COB		
Código	Fluxo/Pot. (aprox.)	€
3096.106.8TL	6W - 480 lm	53,45

3000K | 4000K

8 T

Caixa incluída.





3018

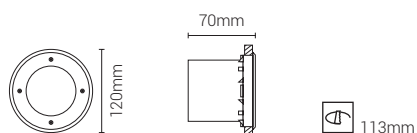

3018 | IP67 | LED GX53

Código	Fluxo/Pot. (aprox.)	€
3018.107.xxL	6.5W - 650 lm	50,65
3018.107.8xL	6.5W - 650 lm	48,36

3000K | 4000K

1 2 7 8 9 F T

Caixa incluída.

3095

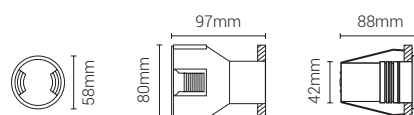

3095 | IK10 | IP67 | LED

Código	Saídas de Luz	Fluxo/Pot. (aprox.)	€
3095.153.8TL	1	3W - 2 lm	54,55
3095.253.8TL	2	3W - 2 lm	54,55
3095.453.8TL	4	3W - 2 lm	54,55

3000K | 4000K

8 T

Caixa incluída.

2527

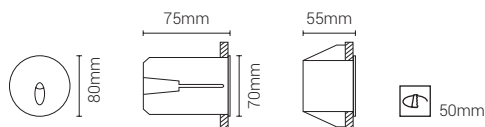

2527 | IK10 | IP65 | LED

Código	Fluxo/Pot. (aprox.)	€
2527.003.xTL	2.8W - 180 lm	41,82

3000K | 4000K

2 9 T

Caixa incluída.

2525

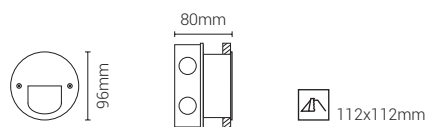

2525 | IK10 | IP65 | LED

Código	Fluxo/Pot. (aprox.)	€
2525.015.xTL	1.5W - 60 lm	39,99

2700K | 3000K | 4000K

2 9 T

Caixa incluída.





3092

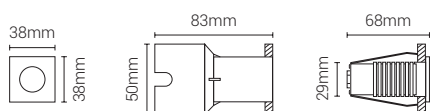

3092 IK06 IP67 LED		
Código	Fluxo/Pot. (aprox.)	€
3092.102.8FL	1.8W - 35 lm	45,82

3000K | 4000K

8 F

Caixa incluída.

3094

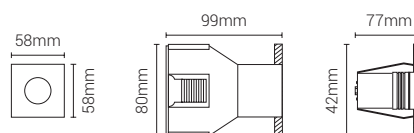

3094 IK08 IP67 LED		
Código	Fluxo/Pot. (aprox.)	€
3094.103.8TL	2.8W - 150 lm	39,99

2700K | 3000K | 4000K

8 T

Caixa incluída.

3097

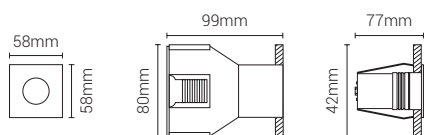

3097 IK08 IP67 COB		
Código	Fluxo/Pot. (aprox.)	€
3097.106.8TL	6W - 480 lm	54,55

3000K | 4000K

8 T

Caixa incluída.





3019

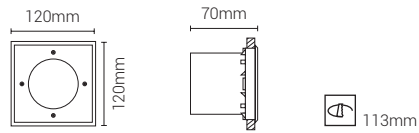

3019 | IP67 | LED GX53

Código	Fluxo/Pot. (aprox.)	€
3019.100.xxL	GX53	39,33
3019.106.8xL	6.5W - 650 lm	49,89

3000K | 4000K

1 2 7 8 9 F T

Caixa incluída.

2528

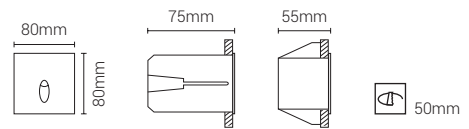

2528 | IK10 | IP65 | LED

Código	Fluxo/Pot. (aprox.)	€
2528.003.xTL	2.8W - 180 lm	41,82

2700K | 3000K | 4000K

2 9 T

Caixa incluída.

2526

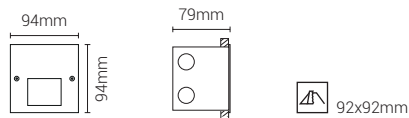

2526 | IK10 | IP65 | LED

Código	Fluxo/Pot. (aprox.)	€
2526.015.xTL	1.5W - 60 lm	40,00

3000K | 4000K

2 9 T

Caixa incluída.

2019

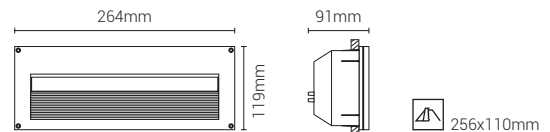

2019 | IP54 | E27 | Módulo LED

Código	Fluxo/Pot. (aprox. 183lm/W)	€
2019.100.xFX	E27	35,82
2119.106.xFL	650 lm	55,54

3000K | 4000K

1 2 7 9 F

Caixa incluída.





2001

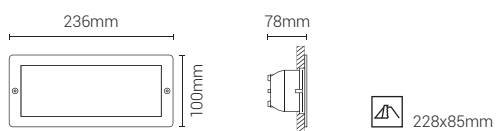
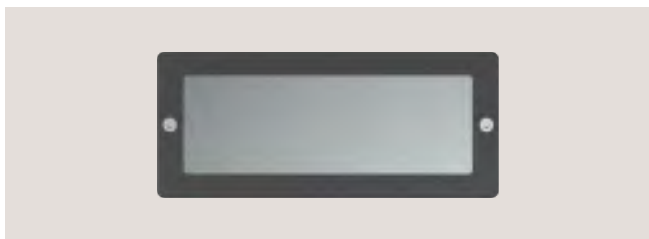

2001 | IK05 | IP54 | E27 | Módulo LED

Código	Fluxo/Pot. (aprox.)	€
2001.100.xOX	E27	19,69
2101.105.xOL	4.8W - 730 lm	49,83
9902.000.XXX	Caixa	1,82

3000K | 4000K

1 2 7 9 0

2002

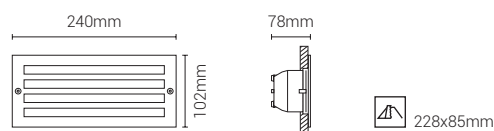

2002 | IK05 | IP54 | E27 | Módulo LED

Código	Fluxo/Pot. (aprox.)	€
2002.100.xOX	E27	22,25
2002.105.xOL	4.8W - 730 lm	55,61
9902.000.XXX	Caixa	1,82

3000K | 4000K

1 2 7 9 0

2011

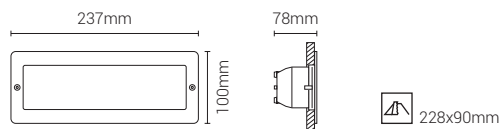

2011 | IK05 | IP54 | E27 | Módulo LED

Código	Fluxo/Pot. (aprox.)	€
2011.100.xOX	E27	21,88
2011.100.8OX	E27	22,32
2011.105.xOL	4.8W - 730 lm	53,04
2011.105.8OL	4.8W - 730 lm	52,11
9902.000.XXX	Caixa	1,82

3000K | 4000K

1 2 7 8 9 0

2009

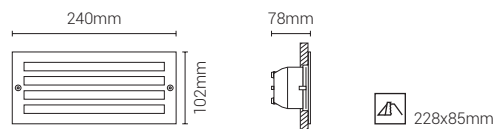
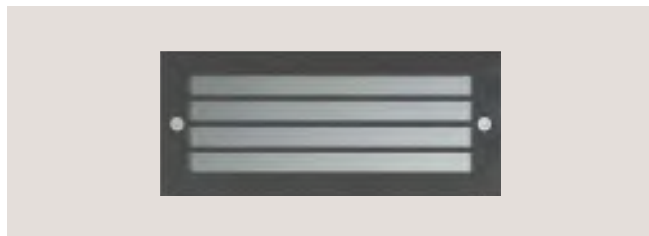

2009 | IK05 | IP54 | E27 | Módulo LED

Código	Fluxo/Pot. (aprox.)	€
2009.100.xOX	E27	24,61
2009.100.8OX	E27	25,07
2009.105.xOL	4.8W - 730 lm	58,11
2009.105.8OL	4.8W - 730 lm	57,03
9902.000.XXX	Caixa	1,82

3000K | 4000K

1 2 7 8 9 0





2010

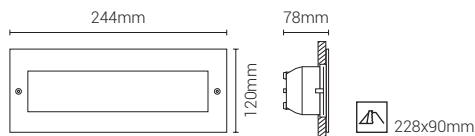
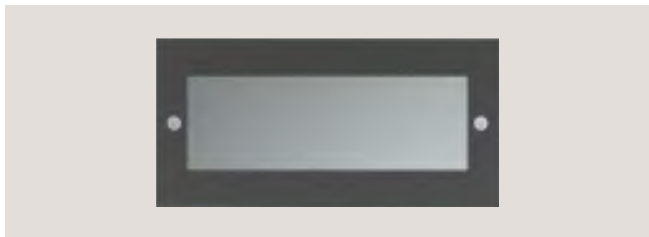

2014

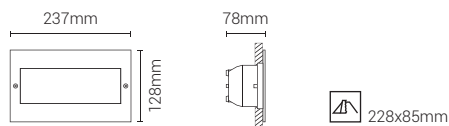

2010 IK05 IP54 E27 Módulo LED		
Código	Fluxo/Pot. (aprox.)	€
2010.100.xOX	E27	21,76
2010.100.8OX	E27	24,82
2010.105.xOL	4.8W - 730 lm	51,56
2010.105.8OL	4.8W - 730 lm	54,62
9902.000.XXX	Caixa	1,82

3000K | 4000K



2014 IK05 IP54 E27 Módulo LED		
Código	Fluxo/Pot. (aprox.)	€
2014.100.xOX	E27	25,41
2014.100.8OX	E27	24,33
2014.105.xOL	4.8W - 730 lm	55,20
2014.105.8OL	4.8W - 730 lm	54,12
9902.000.XXX	Caixa	1,82

3000K | 4000K



2012

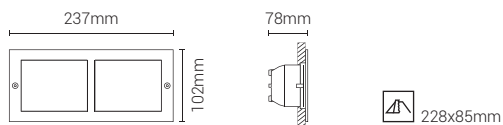

2013

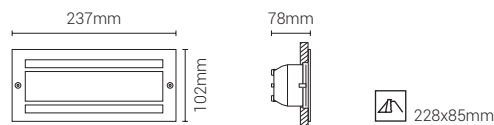
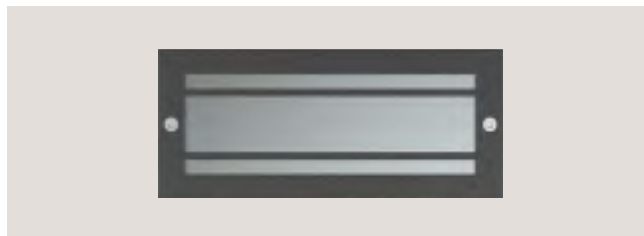

2012 IK05 IP54 E27 Módulo LED		
Código	Fluxo/Pot. (aprox.)	€
2012.100.xOX	E27	26,18
2012.100.8OX	E27	25,10
2112.105.xOL	4.8W - 730 lm	58,14
2112.105.8OL	4.8W - 730 lm	57,06
9902.000.XXX	Caixa	1,82

3000K | 4000K



2013 IK05 IP54 E27 Módulo LED		
Código	Fluxo/Pot. (aprox.)	€
2013.100.xOX	E27	25,44
2013.100.8OX	E27	24,36
2013.105.xOL	4.8W - 730 lm	57,40
2013.105.8OL	4.8W - 730 lm	56,32
9902.000.XXX	Caixa	1,82

3000K | 4000K

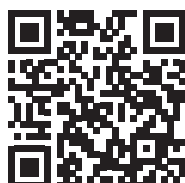



2015

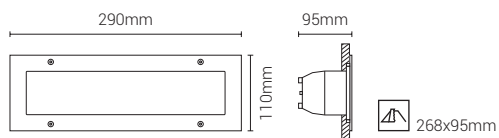

2015 IK05 IP54 E27 Módulo LED		
Código	Fluxo/Pot. (aprox.)	€
2015.100.xOX	E27	37,93
2015.100.8OX	E27	40,92
2015.105.xOL	4.8W - 730 lm	72,61
2015.105.8OL	4.8W - 730 lm	75,60
9912.000.XXX	Caixa	10,97

3000K | 4000K



2018

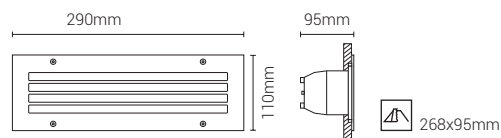

2018 IK05 IP54 E27 Módulo LED		
Código	Fluxo/Pot. (aprox.)	€
2018.100.xOX	E27	42,96
2018.100.8OX	E27	41,57
2018.105.xOL	4.8W - 730 lm	77,83
2018.105.8OL	4.8W - 730 lm	76,25
9912.000.XXX	Caixa	10,97

3000K | 4000K



2016

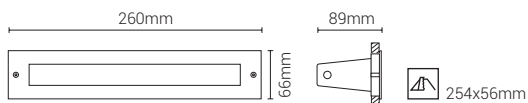
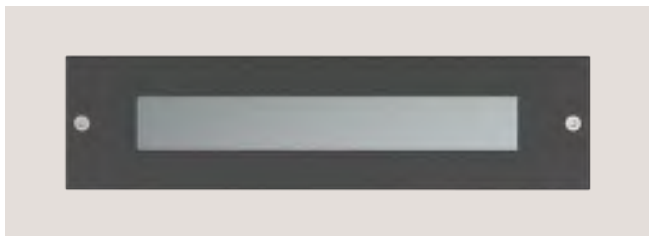

2016 IK04 IP54 Módulo LED		
Código	Fluxo/Pot. (aprox. 183lm/W)	€
2016.105.xOL	650 lm	57,06
2016.105.8OL	650 lm	59,69
9922.000.XXX	Caixa	9,67

3000K | 4000K



2516

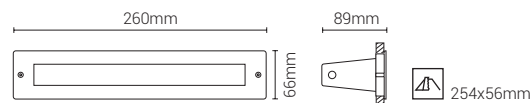
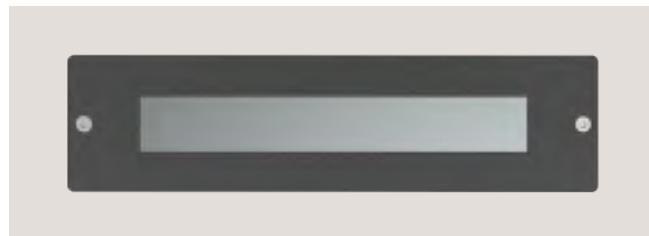

2516 IK04 IP54 Módulo LED		
Código	Fluxo/Pot. (aprox. 183lm/W)	€
2516.105.xOL	650 lm	60,15
2516.105.8OL	650 lm	59,22
9922.000.XXX	Caixa	9,67

3000K | 4000K





3063



Vidro transparente como opção.

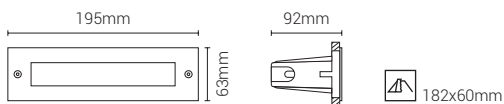

3063 | IK08 | IP67 | LED

Código	Fluxo/Pot. (aprox.)	€
3063.302.xFL	6.5W - 400 lm	69,09
3063.302.8FL	6.5W - 400 lm	72,73
3063.302.xTL	6.5W - 400 lm	69,09
3063.302.8TL	6.5W - 400 lm	72,73

3000K | 4000K



Caixa incluída.

3064



Vidro transparente como opção.

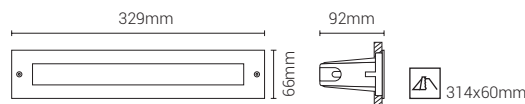

3064 | IK08 | IP67 | LED

Código	Fluxo/Pot. (aprox.)	€
3064.302.xFL	13W - 750 lm	114,55
3064.302.8FL	13W - 750 lm	109,09
3064.302.xTL	13W - 750 lm	114,55
3064.302.9TL	13W - 750 lm	109,09

3000K | 4000K



Caixa incluída.

2017

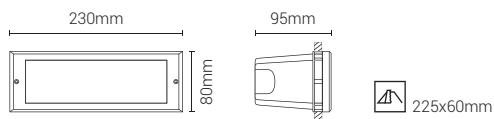

2017 | IP65 | E27 | Módulo LED

Código	Fluxo/Pot. (aprox. 183lm/W)	€
2017.100.xOX	E27	36,01
2017.106.xOL	650 lm	56,93

3000K | 4000K



Caixa incluída.

2517

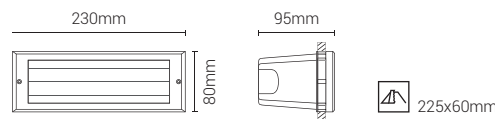

2517 | IP65 | E27 | Módulo LED

Código	Fluxo/Pot. (aprox. 183lm/W)	€
2517.100.xOX	E27	37,65
2517.106.xOL	650 lm	58,57

3000K | 4000K



Caixa incluída.





2522



2522 IK10 IP65 LED		
Código	Fluxo/Pot. (aprox.)	€
2522.103.xFL	3W - 285 lm	73,38
2522.105.xFL	5W - 570 lm	75,82

3000K | 4000K

1 2 7 9 F

Caixa incluída.

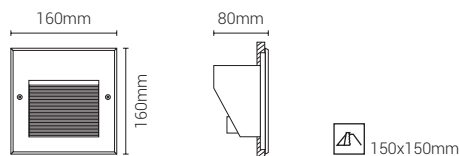

2523



2523 IK10 IP65 LED		
Código	Fluxo/Pot. (aprox.)	€
2523.103.xFL	3W - 285 lm	60,92
2523.105.xFL	5W - 570 lm	62,44

3000K | 4000K

1 2 7 9 F

Caixa incluída.

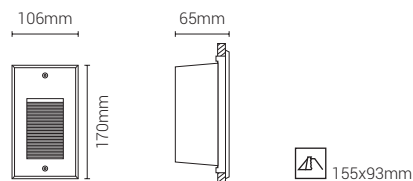

2524



2524 IK10 IP65 LED		
Código	Fluxo/Pot. (aprox.)	€
2524.103.xFL	3W - 285 lm	56,63
2524.105.xFL	5W - 570 lm	59,07

3000K | 4000K

1 2 7 9 F

Caixa incluída.

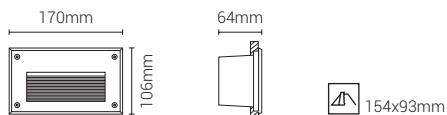



2005.101

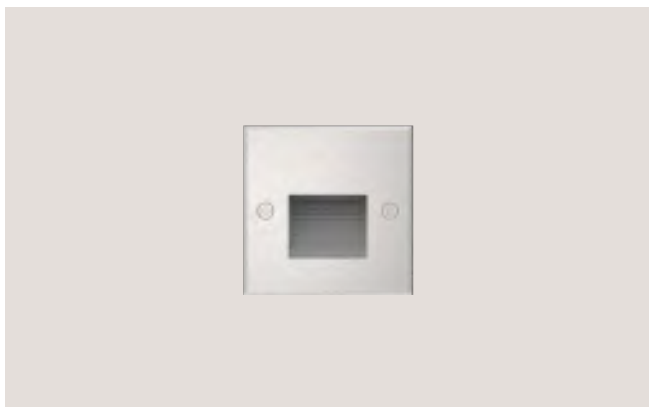

2005.101 | IP54 | LED

Código	Fluxo/Pot. (aprox.)	€
2005.101.8FL	1W - 30 lm	58,18

3000K | 4000K

8 F

Caixa incluída.

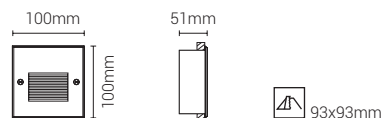

2005.102



2005.102 | IP54 | LED

Código	Fluxo/Pot. (aprox.)	€
2005.102.8FL	2W - 52 lm	68,73

3000K | 4000K

8 F

Caixa incluída.

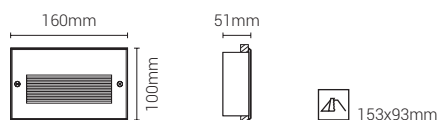

2005.103



2005.103 | IP54 | LED

Código	Fluxo/Pot. (aprox.)	€
2005.103.8FL	3W - 93 lm	79,64

3000K | 4000K

8 F

Caixa incluída.

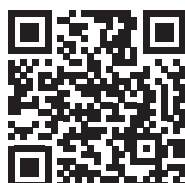
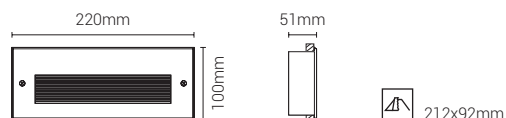



Saliente de Parede ou Teto

▶ **Luminária saliente, diferentes projeções de luz**



2071 Pg. 202



2081 Pg. 202



2073 Pg. 202



2074 Pg. 202

Saliente de Parede

▶ **Luminária saliente, diferentes projeções de luz**



2072 Pg. 203



2082 Pg. 203



2085 Pg. 203



2086 Pg. 203



2029 Pg. 204



2028 Pg. 204

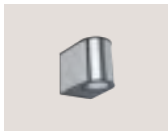

2087 Pg. 204



2088 Pg. 204



2066 Pg. 205



2067 Pg. 205



2568 Pg. 205



2569 Pg. 205



2063 Pg. 206



2064 Pg. 206



2065 Pg. 206



2030 Pg. 207



2031 Pg. 207



2032 Pg. 207



2039 Pg. 207



2530 Pg. 208



2531 Pg. 208



2532 Pg. 208



2533 Pg. 208



2036 Pg. 210



2037 Pg. 210



2038 Pg. 210



2033 Pg. 211



2034 Pg. 211

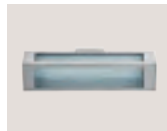

2035 Pg. 211



2040 Pg. 212



2077 Pg. 212



2075 Pg. 212



2076 Pg. 212

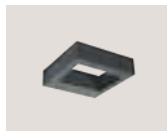

2566 Pg. 213



2041 Pg. 213

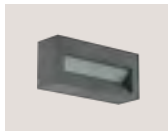

2020 Pg. 213



2071

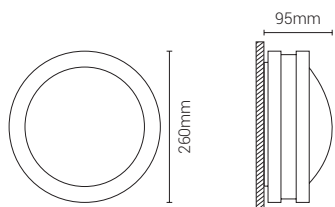

2071 IP54 E27 LED		
Código	Fluxo/Pot. (aprox.)	€
2071.200.xOX	E27	47,79
2071.115.xOL	13W - 1500 lm	94,33

3000K | 4000K



2081

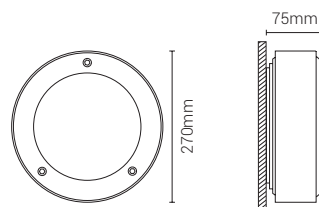

2081 IP54 E27 LED		
Código	Fluxo/Pot. (aprox.)	€
2081.200.xOX	E27	41,23
2081.118.xOL	13W - 1500 lm	87,78

3000K | 4000K



2073

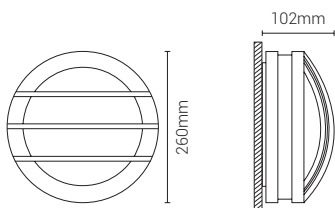

2073 IP54 E27 LED		
Código	Fluxo/Pot. (aprox.)	€
2073.200.xOX	E27	57,46
2073.115.xOL	13W - 1500 lm	104,01

3000K | 4000K



2074

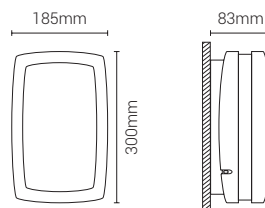

2074 IP54 E27 LED		
Código	Fluxo/Pot. (aprox.)	€
2074.200.xOX	E27	63,73
2074.115.xOL	9.6W - 1460 lm	110,28

3000K | 4000K

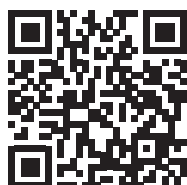



2072

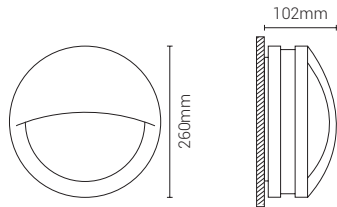

2072 IP54 E27 LED		
Código	Fluxo/Pot. (aprox.)	€
2072.200.xOX	E27	50,81
2072.115.xOL	13W - 1500 lm	97,36

3000K | 4000K

1 2 7 9 0

2082

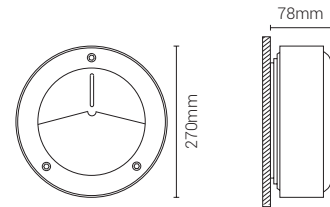

2082 IP54 E27 LED		
Código	Fluxo/Pot. (aprox.)	€
2082.200.xOX	E27	42,93
2082.118.xOL	13W - 1500 lm	89,48

3000K | 4000K

1 2 7 9 0

2085

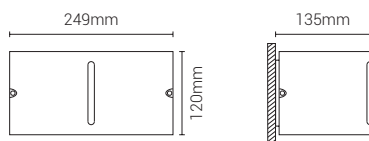

2085 IP54 E27 LED		
Código	Fluxo/Pot. (aprox.)	€
2085.100.xOX	E27	39,47
2085.110.xOL	10W - 1200 lm	86,58

3000K | 4000K

1 2 7 9 0

2086

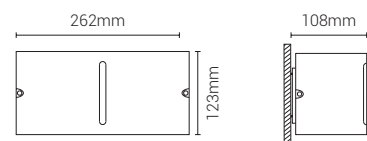

2086 IP54 E27 LED		
Código	Fluxo/Pot. (aprox.)	€
2086.200.80X	E27	35,48
2086.110.80L	10W - 1200 lm	82,03

3000K | 4000K

8 0





2029

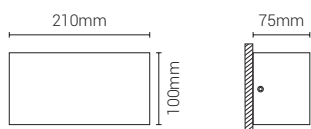

2029 IP54 LED		
Código	Fluxo/Pot. (aprox. 183lm/W)	€
2029.206.xFL	1300 lm	145,40

3000K | 4000K

1 2 7 8 9 F

2028

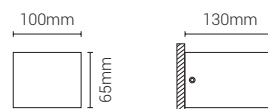

2028 IK06 IP54 LED		
Código	Fluxo/Pot. (aprox.)	€
2028.107.xFL	6.5W - 650 lm	91,98

3000K | 4000K

1 2 7 8 9 F

2087

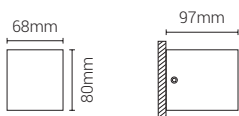

2087 IK06 IP54 LED		
Código	Fluxo/Pot. (aprox.)	€
2087.109.8TL	9W - 500 lm	45,82

3000K | 4000K

8 T

2088

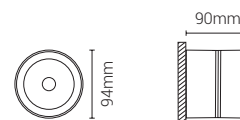

2088 IK06 IP54 LED		
Código	Fluxo/Pot. (aprox.)	€
2088.111.7TL	11W - 840 lm	43,64

3000K | 4000K

7 T

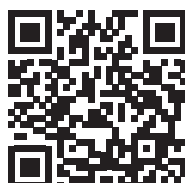
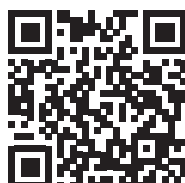



2066

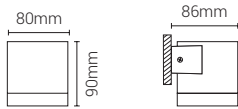

2066 | IP54 | LED GU10

Código	Fluxo/Pot. (aprox.)	€
2066.100.xTX	GU10	32,87
2066.105.xTL	5W - 380 lm	39,06

3000K | 4000K



2067

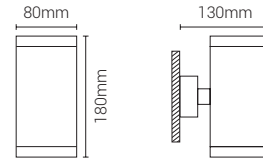

2067 | IP54 | LED GU10

Código	Fluxo/Pot. (aprox.)	€
2067.200.xTX	GU10	76,78
2067.205.xTL	(2x) 5W - (2x) 380 lm	89,15

3000K | 4000K



2568

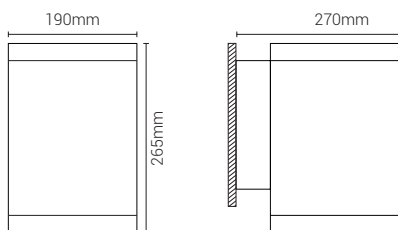

2568 | IK08 | IP65 | LED

Código	Fluxo/Pot. (aprox.)	€
2568.130.xPL	30W - 2600 lm	248,00

3000K | 4000K



2569

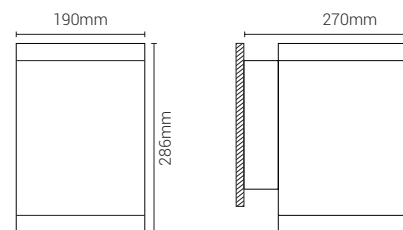

2569 | IK08 | IP65 | LED

Código	Fluxo/Pot. (aprox.)	€
2569.230.xPL	60W - (2x) 2300 lm	354,18

3000K | 4000K





2063

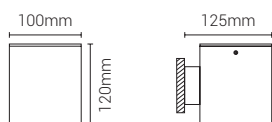

2063 IK06 IP54 LED G9		
Código	Fluxo/Pot. (aprox.)	€
2063.100.xFX	G9	70,92
2063.100.8FX	G9	105,80
2063.103.xFL	2.5W - 250 lm	77,31
2063.103.8FL	2.5W - 250 lm	112,19

3000K | 4000K

1 2 7 8 9 F

2064

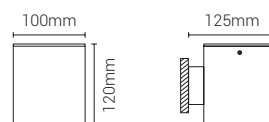

2064 IK06 IP54 LED GU10		
Código	Fluxo/Pot. (aprox.)	€
2064.100.xTX	GU10	61,70
2064.100.8TX	GU10	92,10
2064.105.xTL	5W - 380 lm	67,88
2064.105.8TL	5W - 380 lm	98,28

2700K | 3000K | 4000K

1 2 7 8 9 T

2065

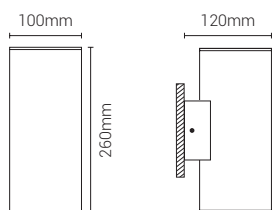

2065 IK06 IP54 LED GU10		
Código	Fluxo/Pot. (aprox.)	€
2065.200.xTX	(2x) GU10	87,39
2065.200.8TX	(2x) GU10	126,57
2065.205.xTL	(2x) 5W - 380 lm	97,11
2065.205.8TL	(2x) 5W - 380 lm	138,94

3000K | 4000K

1 2 7 8 9 T





2030

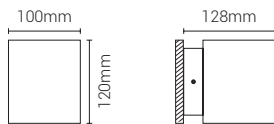

2030 | IK06 | IP54 | LED G9

Código	Fluxo/Pot. (aprox.)	€
2030.100.xFX	G9	65,62
2030.100.8FX	G9	120,42
2030.103.xFL	2.5W - 250 lm	72,00
2030.103.8FL	2.5W - 250 lm	126,80

3000K | 4000K

1 2 7 8 9 F

2031

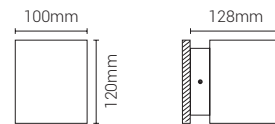
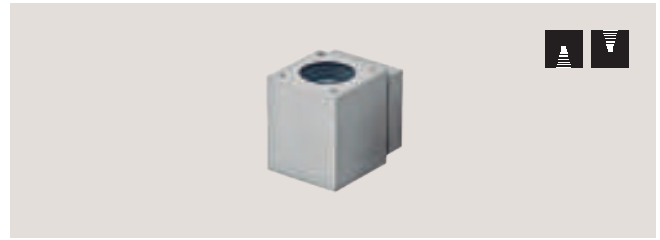

2031 | IK06 | IP54 | LED GU10

Código	Fluxo/Pot. (aprox.)	€
2031.100.xTX	GU10	63,36
2031.100.8TX	GU10	117,02
2031.105.xTL	5W - 380 lm	69,55
2031.105.8TL	5W - 380 lm	123,20

2700K | 3000K | 4000K

1 2 7 8 9 T

2032

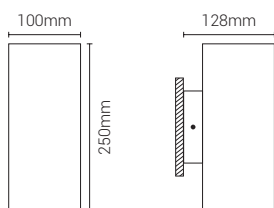

2032 | IK06 | IP54 | LED GU10

Código	Fluxo/Pot. (aprox.)	€
2032.200.xTX	GU10	74,43
2032.200.8TX	GU10	135,26
2032.205.xTL	(2x) 5W - 380 lm	86,79
2032.205.8TL	(2x) 5W - 380 lm	147,62

2700K | 3000K | 4000K

1 2 7 8 9 T

2039

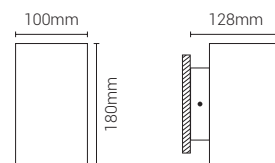

2039 | IK06 | IP54 | E27

Código	Fluxo/Pot. (aprox.)	€
2039.100.xFX	E27	61,39
2039.100.8FX	E27	101,10

1 2 7 8 9 F





2530

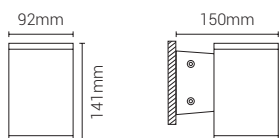

2530 IK06 IP65 LED		
Código	Fluxo/Pot. (aprox.)	€
2530.109.xPL	9W - 850 lm	102,18

3000K | 4000K 1 7 9 P

2531

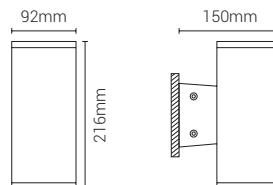

2531 IK06 IP65 LED		
Código	Fluxo/Pot. (aprox.)	€
2531.209.xPL	(2x) 7.5W - 840 lm	154,55

3000K | 4000K 1 7 9 P

2532

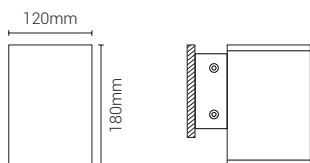

2532 IK06 IP65 LED		
Código	Fluxo/Pot. (aprox.)	€
2532.115.xPL	15W - 1460 lm	147,27

3000K | 4000K 1 7 9 P

2533

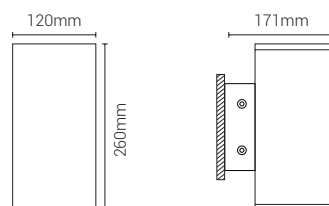

2533 IK06 IP65 LED		
Código	Fluxo/Pot. (aprox.)	€
2533.213.xPL	(2x) 10.8W - 1045 lm	199,27

3000K | 4000K 1 7 9 P







2036



2036 IK04 IP54 E27 Módulo LED		
Código	Fluxo/Pot. (aprox. 183lm/W)	€
2036.100.xOX	E27	77,43
2036.100.8OX	E27	125,06
2036.107.xOL	1100 lm	105,99
2036.107.8OL	1100 lm	153,62

3000K | 4000K

1 2 7 8 9 0

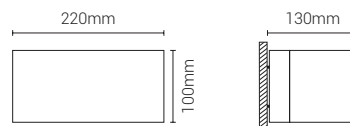

2037



2037 IK04 IP54 E27 Módulo LED		
Código	Fluxo/Pot. (aprox. 183lm/W)	€
2037.100.xOX	E27	87,63
2037.100.8OX	E27	135,69
2037.207.xOL	2200 lm	132,35
2037.207.8OL	2200 lm	180,42

3000K | 4000K

1 2 7 8 9 0

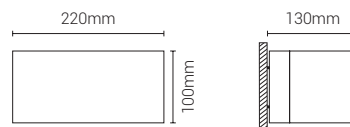

2038



2038 IK04 IP54 E27 Módulo LED		
Código	Fluxo/Pot. (aprox.)	€
2038.100.xOX	E27	97,83
2038.100.8OX	E27	142,80
2038.307.xOL	3300 lm	158,72
2038.307.8OL	3300 lm	206,79

3000K | 4000K

1 2 7 8 9 0

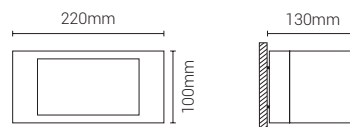



2033



2033 | IK04 | IP54 | PL-L LED | Módulo LED

Código	Fluxo/Pot. (aprox. 183lm/W)	€
2033.116.xFL	PL-L LED 16W	128,37
2033.116.8FL	PL-L LED 16W	193,68
2033.115.xFL	2200 lm	132,04
2033.115.8FL	2200 lm	197,35

2033.116: 3000K | 4000K | 6500K

2033.115: 2700K | 3000K | 4000K | 5000K | 6000K

1 2 7 8 9 F

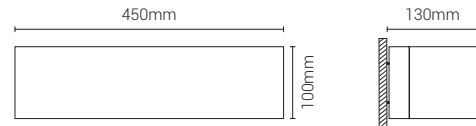

2034



2034 | IK04 | IP54 | PL-L LED | Módulo LED

Código	Fluxo/Pot. (aprox. 183lm/W)	€
2034.216.xFL	PL-L LED 16W	141,35
2034.216.8FL	PL-L LED 16W	202,06
2034.215.xFL	4400 lm	160,94
2034.215.8FL	4400 lm	221,65

2034.216: 3000K | 4000K | 6500K

2034.215: 2700K | 3000K | 4000K | 5000K | 6000K

1 2 7 8 9 F

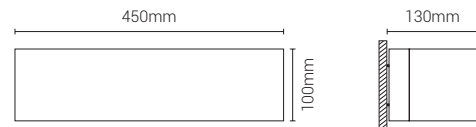

2035



2035 | IK04 | IP54 | PL-L LED | Módulo LED

Código	Fluxo/Pot. (aprox. 183lm/W)	€
2035.316.xFL	PL-L LED 16W	154,33
2035.316.8FL	PL-L LED 16W	214,39
2035.315.xFL	6600 lm	189,84
2035.315.8FL	6600 lm	245,93

2035.316: 3000K | 4000K | 6500K

2035.315: 2700K | 3000K | 4000K | 5000K | 6000K

1 2 7 8 9 F

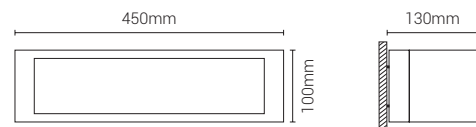



2040

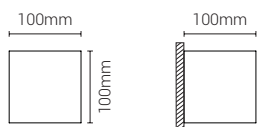

2040 IP65 COB		
Código	Fluxo/Pot. (aprox.)	€
2040.107.xTL	7W - 560 lm	33,41

3000K | 4000K

1 2 7 9

2077

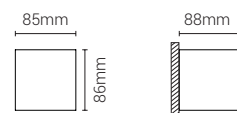

2077 IK06 IP54 LED		
Código	Fluxo/Pot. (aprox.)	€
2077.109.xTL	9W - 850 lm	32,76

3000K | 4000K

1 7 T

2075

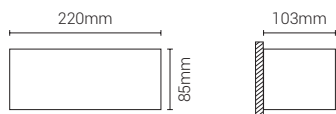

2075 IK06 IP54 LED		
Código	Fluxo/Pot. (aprox.)	€
2075.120.1TL	20W - 1230 lm	75,60

3000K | 4000K

1 7 T

2076

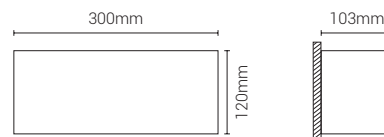

2076 IK06 IP54 LED		
Código	Fluxo/Pot. (aprox.)	€
2076.142.1OL	42W - 3400 lm	123,48

3000K | 4000K

1 7 O

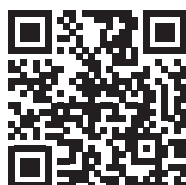



2566

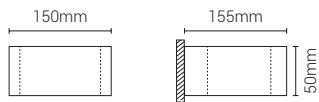
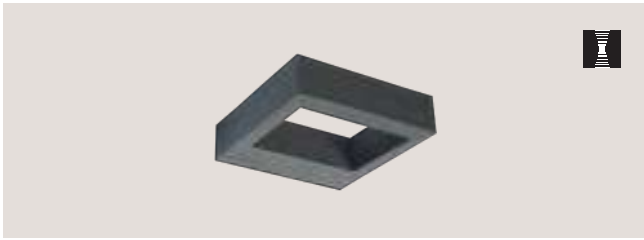

2566 | IK06 | IP54 | LED

Código	Fluxo/Pot. (aprox.)	€
2566.109.xPL	9W - 580 lm	68,36

3000K | 4000K

1 7 9 P

2041

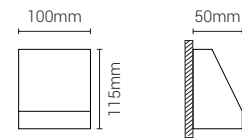
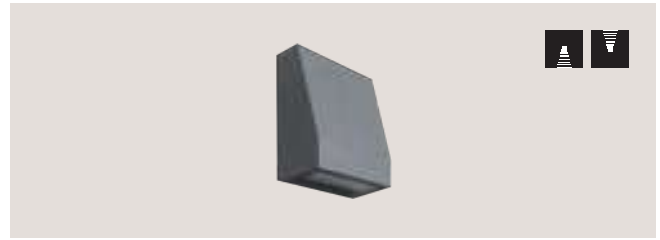

2041 | IK06 | IP54 | COB

Código	Fluxo/Pot. (aprox.)	€
2041.103.xPL	3W - 300 lm	39,64

3000K | 4000K

1 2 7 9 P

2020

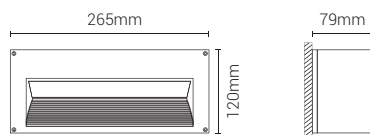

2020 | IP54 | E27 | Módulo LED

Código	Fluxo/Pot. (aprox. 183lm/W)	€
2020.100.xFX	E27	36,78
2020.106.xFL	650 lm	57,71

3000K | 4000K

1 2 7 9 F

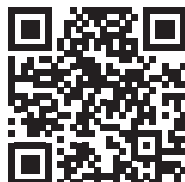



Índice Fotográfico

Redondas de Encastrar no Piso

Luminária de encastrar, projeção de luz ascendente ou lateral



3091 Pg. 216



3093 Pg. 216



3096 Pg. 216



3005 Pg. 216



3014 Pg. 217



3026 Pg. 217



3001 Pg. 217



3003 Pg. 217



3004 Pg. 218



3007 Pg. 218



3018 Pg. 218



3027 Pg. 218



3010 Pg. 219



3008 Pg. 219



3002 Pg. 219



3016 Pg. 219



3022 Pg. 220



3023 Pg. 220



3024 Pg. 220



3042 Pg. 221

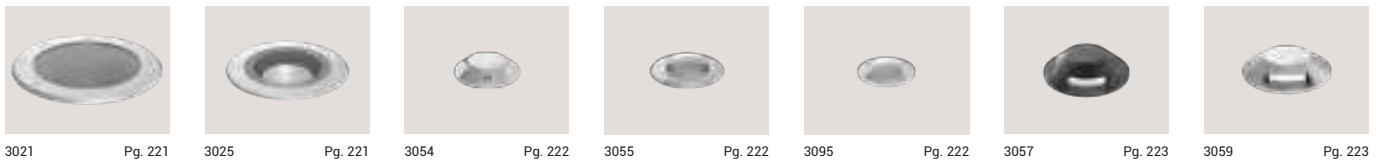

3021 Pg. 221 3025 Pg. 221 3054 Pg. 222 3055 Pg. 222 3095 Pg. 222 3057 Pg. 223 3059 Pg. 223

Quadradas de Encastrar no Piso

Luminária saliente, projeção de luz lateral



3092 Pg. 224 3094 Pg. 224 3097 Pg. 224 3006 Pg. 224 3011 Pg. 225 3015 Pg. 225 3019 Pg. 225
 3012 Pg. 225 3017 Pg. 226 3031 Pg. 226 3052 Pg. 226 3030 Pg. 227 3056 Pg. 227 3063 Pg. 228
 3064 Pg. 228 3065 Pg. 228

Salientes de Piso

Luminária saliente, projeção de luz lateral

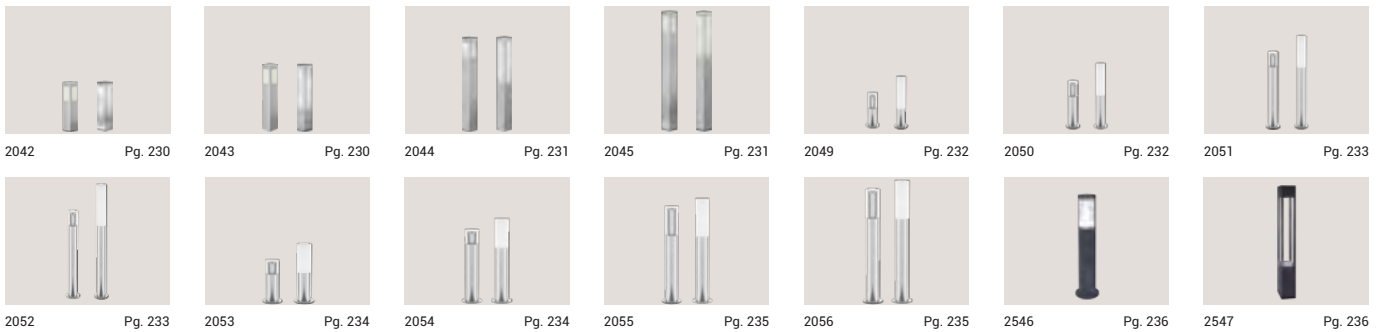

2042 Pg. 230 2043 Pg. 230 2044 Pg. 231 2045 Pg. 231 2049 Pg. 232 2050 Pg. 232 2051 Pg. 233
 2052 Pg. 233 2053 Pg. 234 2054 Pg. 234 2055 Pg. 235 2056 Pg. 235 2546 Pg. 236 2547 Pg. 236

Luminária saliente, projeção de luz orientável



2501 Pg. 238 2502 Pg. 238 2503 Pg. 238 2504 Pg. 239 2505 Pg. 239 2506 Pg. 240 2507 Pg. 240
 2508 Pg. 241 2509 Pg. 241



3091

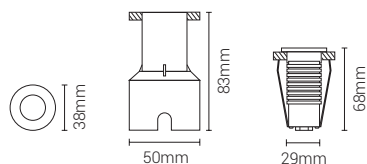

3091 IK06 IP67 LED		
Código	Fluxo/Pot. (aprox.)	€
3091.102.8FL	1.8W - 35 lm	41,99

3000K | 4000K

8 F

3093

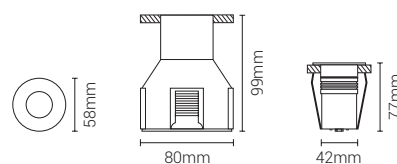

3093 IK08 IP67 LED		
Código	Fluxo/Pot. (aprox.)	€
3093.103.8TL	2.8W - 150 lm	39,98

3000K | 4000K

8 T

3096

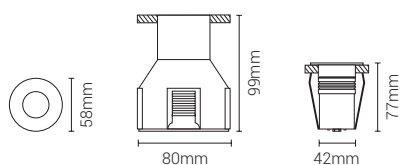

3096 IK08 IP67 COB		
Código	Fluxo/Pot. (aprox.)	€
3096.106.8TL	6W - 480 lm	53,45

3000K | 4000K

8 T

3005



3005 IK07 IP67 LED		
Código	Fluxo/Pot. (aprox.)	€
3005.103.8TL	3.6W - 390 lm	51,27

3000K | 4000K

8 T

Caixas incluídas.





3014

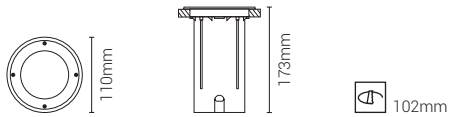

3014 | IK10 | IP67 | LED GU10

Código	Fluxo/Pot. (aprox.)	€
3014.100.8xX	GU10	33,66
3014.105.8xL	5W - 380 lm	39,27

2700K | 3000K | 4000K

8 F T

3026

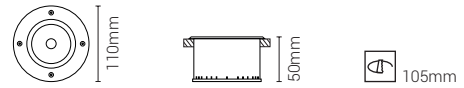

3026 | IK10 | IP67 | LED

Código	Fluxo/Pot. (aprox.)	€
3026.108.8TL	8W - 580 lm	45,82

3000K | 4000K

8 T

3001

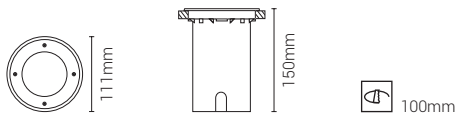

3001 | IK10 | IP67 | LED GU10

Código	Fluxo/Pot. (aprox.)	€
3001.100.8xX	GU10	38,91
3001.105.8xL	5W - 380 lm	45,09

2700K | 3000K | 4000K

8 F T

3003

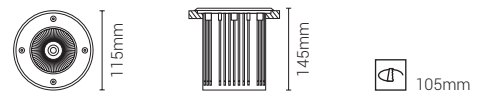

3003 | IK08 | IP67 | COB

Código	Fluxo/Pot. (aprox.)	€
3003.109.8TL	9W - 710 lm	87,64

3000K | 4000K

8 T





3004



3004 | IK08 | IP67 | COB

Código	Fluxo/Pot. (aprox.)	€
3004.104.8TL	3.6W - 278 lm	74,18

3000K | 4000K

8 T

3007

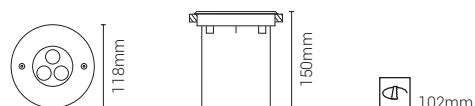

3007 | IK08 | IP67 | LED

Código	Fluxo/Pot. (aprox.)	€
3007.302.8TL	6W - 600 lm	90,91

3000K | 4000K

8 T

3018



3018 | IP67 | LED GX53

Código	Fluxo/Pot. (aprox.)	€
3018.100.8xX	GX53	37,80
3018.107.8xL	6.5W - 650 lm	48,36

3000K | 4000K

8 F T

3027

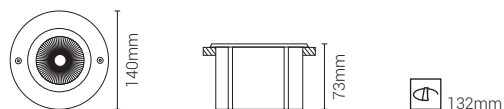

3027 | IK10 | IP67 | COB

Código	Fluxo/Pot. (aprox.)	€
3027.112.8TL	12W - 1030 lm	76,80

3000K | 4000K

8 T

Caixas incluídas.





3010

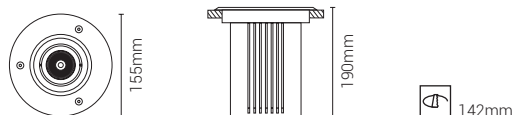

3010 | IK08 | IP67 | COB

Código	Fluxo/Pot. (aprox.)	€
3010.109.8TL	9W - 710 lm	122,55

3000K | 4000K



3008

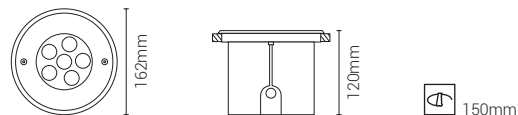

3008 | IK08 | IP67 | LED

Código	Fluxo/Pot. (aprox.)	€
3008.302.8TL	14W - 1200 lm	144,00

3000K | 4000K



3002

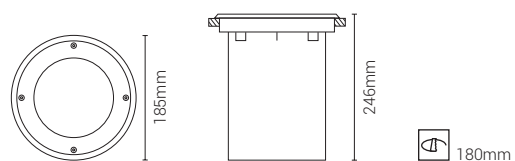

3002 | IK10 | IP67 | E27 | COB

Código	Fluxo/Pot. (aprox.)	€
3002.100.8TX	E27	85,91
3002.127.8TL	COB 27W - 2300 lm	150,05

3000K | 4000K



3016

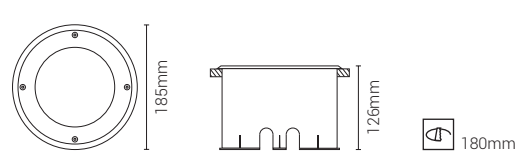

3016 | IK10 | IP67 | LED GU10 AR111 | G53 AR111

Código	Fluxo/Pot. (aprox.)	€
3016.100.8xX	GU10	82,09
3016.116.8xL	GU10 AR111 15W - 1120 lm	101,44
3016.110.8xL	G53 AR111 10W - 570 lm	124,09
3016.115.8xL	G53 AR111 15W - 830 lm	127,91

2700K | 3000K | 4000K





3022



3022 IK08 IP67 COB		
Código	Fluxo/Pot. (aprox.)	€
3022.122.8TL	22W - 1970 lm	252,00

3000K | 4000K

8 T

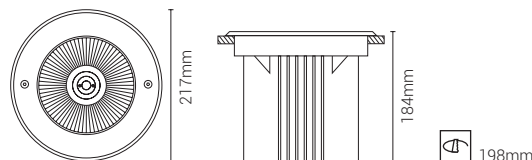

3023



3023 IK08 IP67 COB		
Código	Fluxo/Pot. (aprox.)	€
3023.113.8TL	12.8W - 1053 lm	195,27

3000K | 4000K

8 T

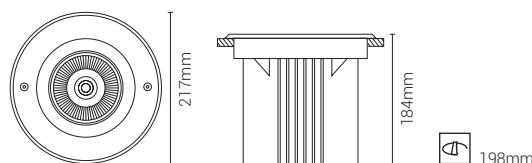

3024



3024 IK08 IP67 COB		
Código	Fluxo/Pot. (aprox.)	€
3024.122.8TL	22W - 1870 lm	253,82

3000K | 4000K

8 T

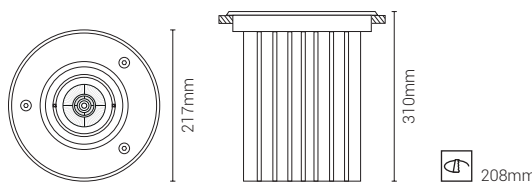

Caixas incluídas.

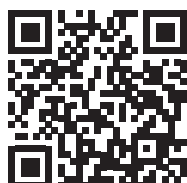



3042



3042 | IK10 | IP67 | E27 | COB

Código	Fluxo/Pot. (aprox.)	€
3042.100.8xX	E27	142,34
3042.137.8xL	COB 37W - 3820 lm	237,80

2700K | 3000K

8 F T

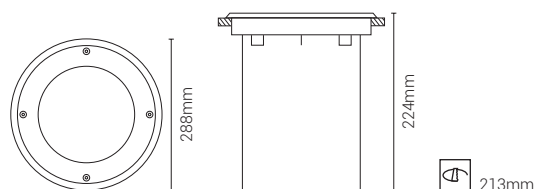

3021



3021 | IK10 | IP67 | E27

Código	Fluxo/Pot. (aprox.)	€
3021.100.8xX	E27	198,55

8 F T

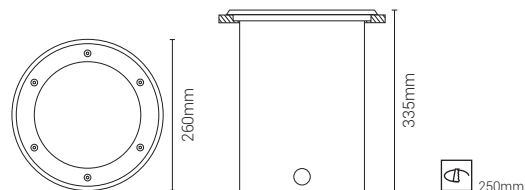

3025



3025 | IK08 | IP67 | COB

Código	Fluxo/Pot. (aprox.)	€
3025.130.8TL	30W - 2547 lm	318,18

3000K | 4000K

8 T

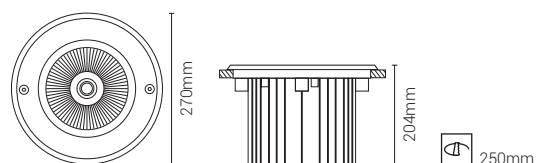



3054



3054 | IK08 | IP67 | LED

Código	Saídas de Luz	Fluxo/Pot. (aprox.)	€
3054.101.8TL	1	1.2W - 46 lm	123,64
3054.201.8TL	2	2.4W - 91 lm	123,64
3054.401.8TL	4	4.8W - 182 lm	123,64

3000K | 4000K

8 T



3055



3055 | IK10 | IP67 | LED GU10

Código	Saídas de Luz	Fluxo/Pot. (aprox.)	€
3055.100.8xX	2	GU10	41,91
3055.105.8xL	2	5W - 380 lm	48,09

2700K | 3000K | 4000K

8 F T

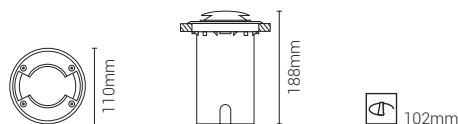

3095



3095 | IK10 | IP67 | LED

Código	Saídas de Luz	Fluxo/Pot. (aprox.)	€
3095.153.8TL	1	3W - 2 lm	54,55
3095.253.8TL	2	3W - 2 lm	54,55
3095.453.8TL	4	3W - 2 lm	54,55

3000K | 4000K

8 T

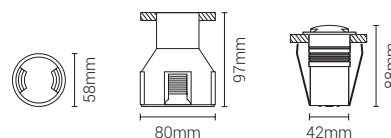

Caixas incluídas.





3057



3057 | IK08 | IP67 | LED

Código	Saídas de Luz	Fluxo/Pot. (aprox.)	€
3057.102.9TL	1	2.4W - 96 lm	87,27
3057.202.9TL	2	4.8W - 192 lm	102,18
3057.402.9TL	4	4.8W - 192 lm	94,55

3000K | 4000K

9 T



3059

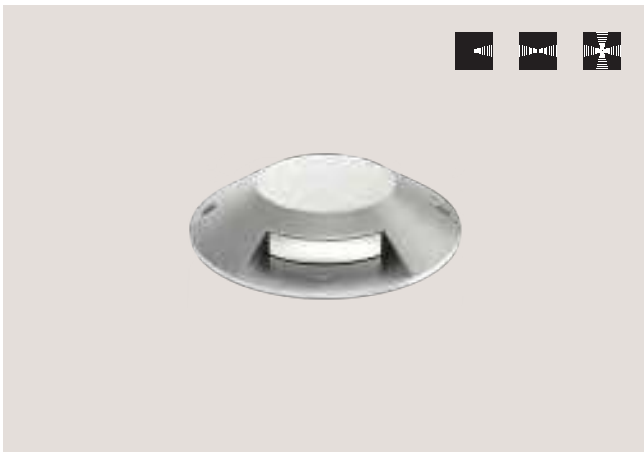

3059 | IK07 | IP67 | LED

Código	Saídas de Luz	Fluxo/Pot. (aprox.)	€
3059.102.8TL	1	2.4W - 96 lm	223,27
3059.202.8TL	2	4.8W - 192 lm	223,27
3059.402.8TL	4	4.8W - 192 lm	223,27

3000K | 4000K

8 T

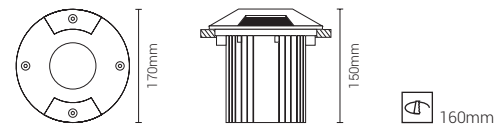



3092

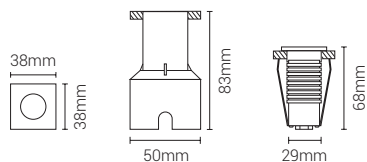

3092 | IK06 | IP67 | LED

Código	Fluxo/Pot. (aprox.)	€
3092.102.8FL	1.8W - 35 lm	45,82

3000K | 4000K

8 F

3094

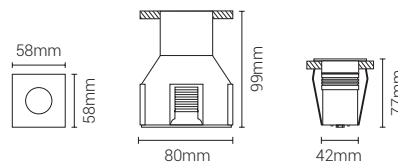

3094 | IK08 | IP67 | LED

Código	Fluxo/Pot. (aprox.)	€
3094.103.8TL	2.8W - 150 lm	39,99

3000K | 4000K

8 T

3097

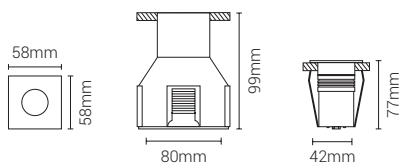

3097 | IK08 | IP67 | COB

Código	Fluxo/Pot. (aprox.)	€
3097.106.8TL	6W - 480 lm	54,55

3000K | 4000K

8 T

3006

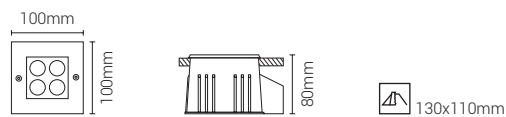
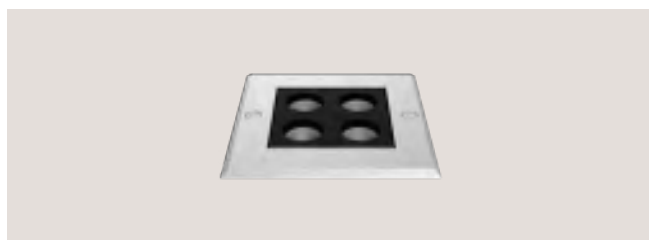

3006 | IK07 | IP67 | LED

Código	Fluxo/Pot. (aprox.)	€
3006.104.8TL	4.8W - 440 lm	80,73

3000K | 4000K

8 T

Caixas incluídas.





3011

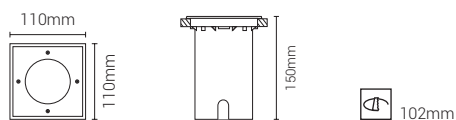

3011 | IK10 | IP67 | LED GU10

Código	Fluxo/Pot. (aprox.)	€
3011.100.8xX	GU10	40,82
3011.105.8xL	5W - 380 lm	47,00

2700K | 3000K | 4000K

8 F T

3015

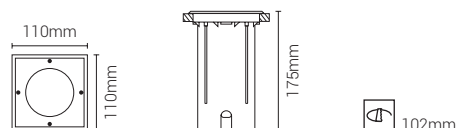

3015 | IK10 | IP67 | LED GU10

Código	Fluxo/Pot. (aprox.)	€
3015.100.8xX	GU10	35,29
3015.105.8xL	5W - 380 lm	41,47

2700K | 3000K | 4000K

8 F T

3019

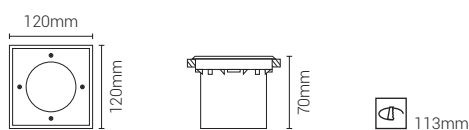

3019 | IP67 | LED GX53

Código	Fluxo/Pot. (aprox.)	€
3019.100.8xX	GX53	39,33
3019.106.8xL	6.5W - 650 lm	49,89

3000K | 4000K

8 F T

3012

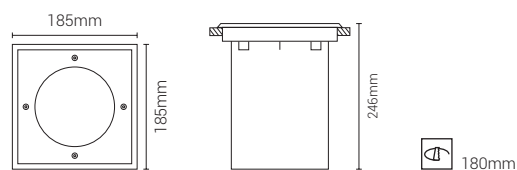

3012 | IK10 | IP67 | E27 | COB

Código	Fluxo/Pot. (aprox.)	€
3012.100.8xX	E27	95,45
3012.127.8xL	COB 27W - 2300 lm	159,60

3000K | 4000K

8 F T

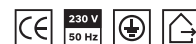



3017

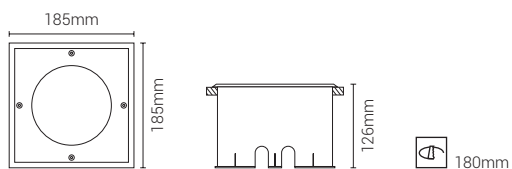

3017 | IK10 | IP67 | LED - GU10 | LED - G53 AR111

Código	Fluxo/Pot. (aprox.)	€
3017.100.8xX	GU10	86,67
3017.116.8xL	GU10 15W - 1120 lm	106,02
3017.110.8xL	G53 AR111 10W - 570 lm	129,82
3017.115.8xL	G53 AR111 15W - 830 lm	132,91

2700K | 3000K | 4000K

8 F T

3031

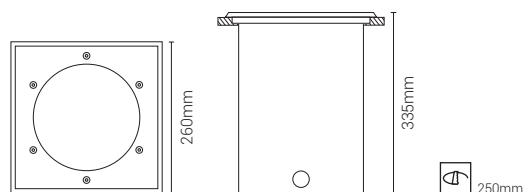

3031 | IK10 | IP67 | E27

Código	Fluxo/Pot. (aprox.)	€
3031.100.8xX	E27	208,64

8 F T

3052

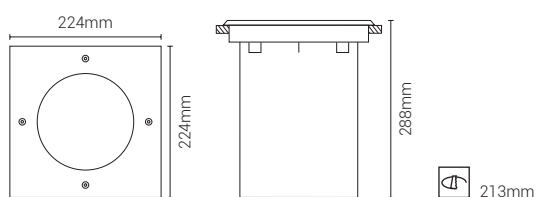

3052 | IK10 | IP67 | E27 | COB

Código	Fluxo/Pot. (aprox.)	€
3052.100.8xX	E27	153,80
3052.137.8xL	COB 37W - 3820 lm	249,25

3000K | 4000K

8 F T

Caixas incluídas.

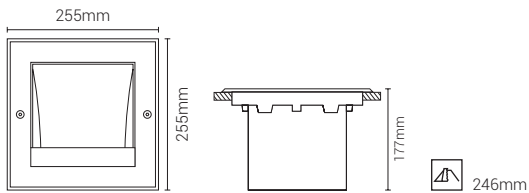
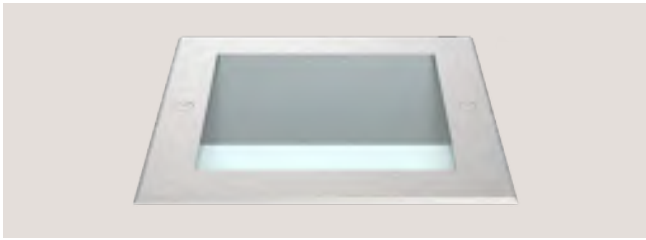

**3030****3030 | IK08 | IP67 | LED**

Código	Fluxo/Pot. (aprox.)	€
3030.145.8TL	45W - 3600 lm	330,18

3000K | 4000K

8 T

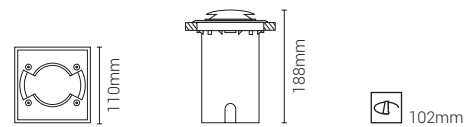
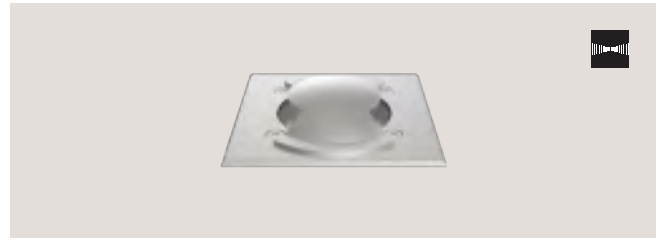
3056**3056 | IK10 | IP67 | LED GU10**

Código	Saídas de Luz	Fluxo/Pot. (aprox.)	€
3056.100.8xX	2	GU10	42,81
3056.105.8xL	2	5W - 380 lm	50,25

2700K | 3000K | 4000K

8 F T





3063



F



T

3063 IK08 IP67 LED		
Código	Fluxo/Pot. (aprox.)	€
3063.302.8xL	(3x) 6.5W - 400 lm	69,09

3000K | 4000K

8 F T

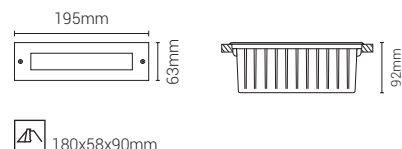

3064



F



T

3064 IK08 IP67 LED		
Código	Fluxo/Pot. (aprox.)	€
3064.602.8xL	(6x) 13W - 750 lm	109,09

3000K | 4000K

8 F T

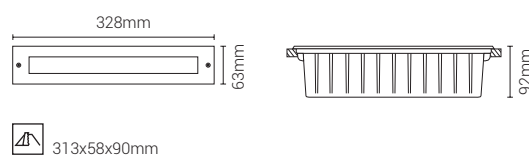

3065



F



T

3065 IK07 IP67 LED		
Código	Fluxo/Pot. (aprox.)	€
3065.106.8xL	7.2W - 575 lm	203,27
3065.115.8xL	18W - 1440 lm	296,00
3065.121.8xL	25W - 2000 lm	384,00
3065.127.8xL	32W - 2580 lm	480,00

3000K | 4000K

8 F T

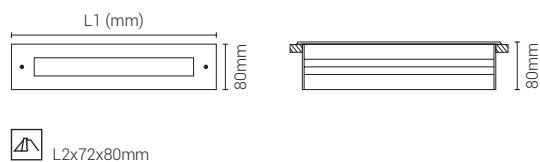

Caixas incluídas.







2042

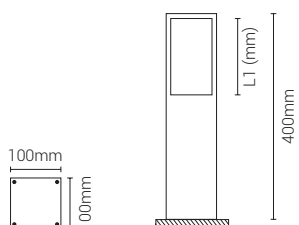

2043

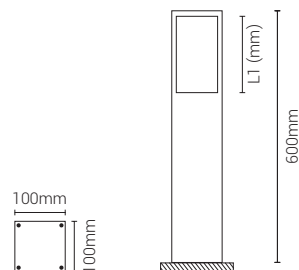

2042 IK08 IP54 E27 PL-L LED			
Código	L1 (mm)	Fluxo/Pot. (aprox.)	€
2042.100.xFX	140	E27	99,46
2042.100.8FX	140	E27	159,10
2042.110.xFL	140	E27 LED 10W - 825 lm	115,24
2042.110.8FL	140	E27 LED 10W - 825 lm	174,88
2042.116.xFL	270	PL-L LED 16W - 2100lm	140,84
2042.116.8FL	270	PL-L LED 16W - 2100lm	200,48

3000K | 4000K

1 2 7 8 9 F

2043 IK08 IP54 E27 PL-L LED			
Código	L1 (mm)	Fluxo/Pot. (aprox.)	€
2043.100.xFX	140	E27	106,21
2043.100.8FX	140	E27	177,28
2043.110.xFL	140	E27 LED 10W - 825 lm	121,99
2043.110.8FL	140	E27 LED 10W - 825 lm	193,06
2043.124.xFL	370	PL-L LED 24W - 3200lm	161,63
2043.124.8FL	370	PL-L LED 24W - 3200lm	225,83

3000K | 4000K

1 2 7 8 9 F





2044

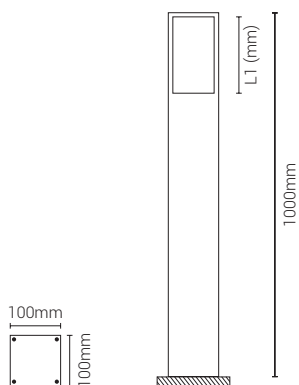

2045

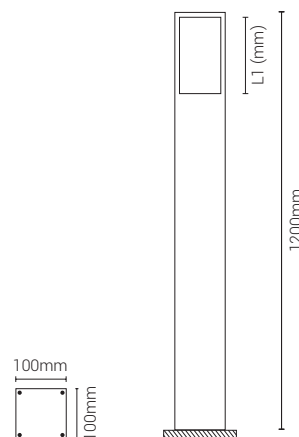
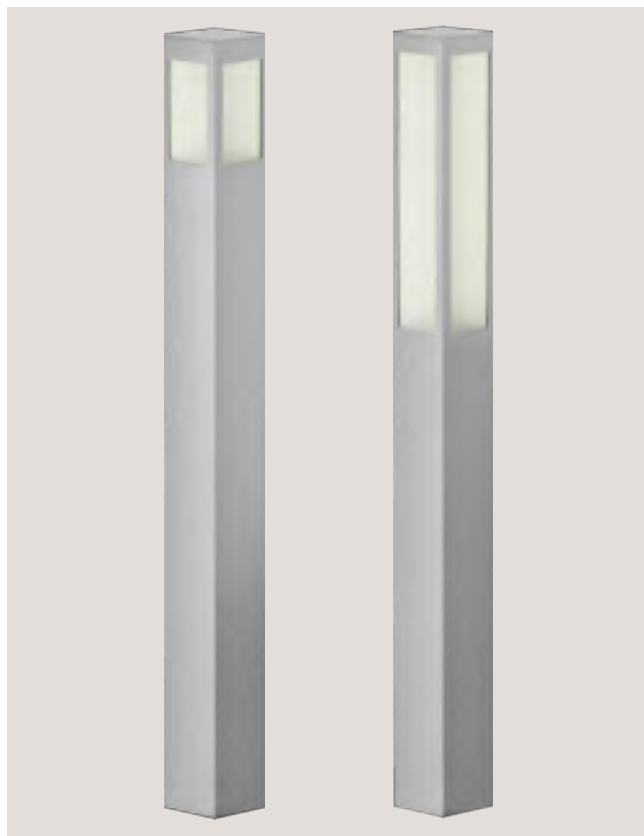

2044 | IK08 | IP54 | E27 | PL-L LED

Código	L1 (mm)	Fluxo/Pot. (aprox.)	€
2044.100.xFX	140	E27	119,80
2044.100.8FX	140	E27	248,23
2044.110.xFL	140	E27 LED 10W - 825 lm	135,58
2044.110.8FL	140	E27 LED 10W - 825 lm	264,01
2044.124.xFL	370	PL-L LED 24W - 3200lm	175,21
2044.124.8FL	370	PL-L LED 24W - 3200lm	303,65

3000K | 4000K

1 2 7 8 9 F

2045 | IK08 | IP54 | E27 | PL-L LED

Código	L1 (mm)	Fluxo/Pot. (aprox.)	€
2045.100.xFX	140	E27	134,86
2045.100.8FX	140	E27	312,61
2045.110.xFL	140	E27 LED 10W - 825 lm	142,71
2045.110.8FL	140	E27 LED 10W - 825 lm	310,01
2045.124.xFL	370	PL-L LED 24W - 3200lm	182,34
2045.124.8FL	370	PL-L LED 24W - 3200lm	348,36

3000K | 4000K

1 2 7 8 9 F

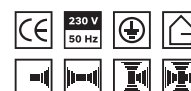

Preço para outras aberturas de luz a pedido



2049

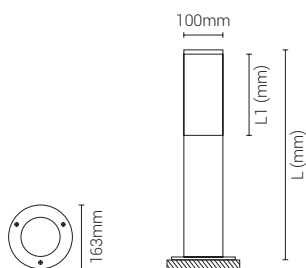
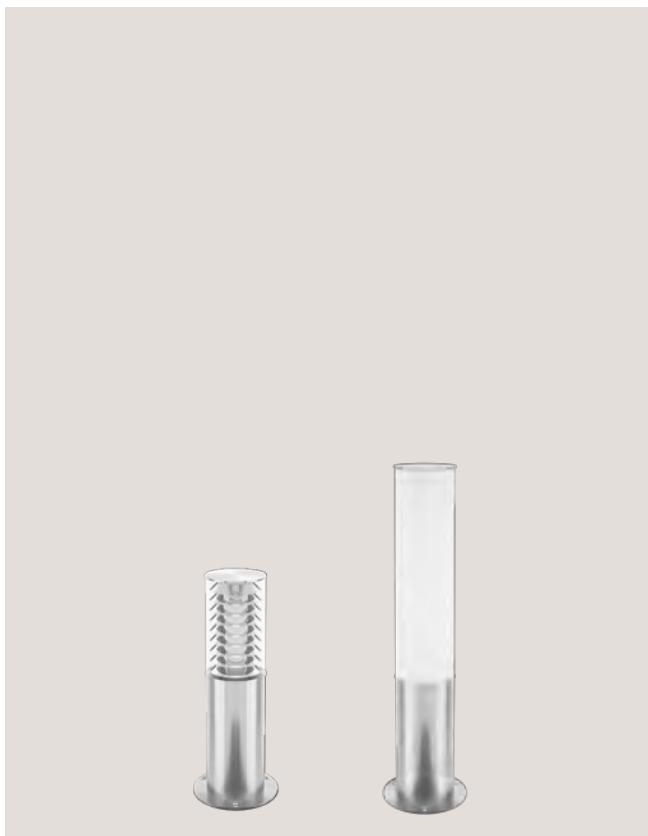

2050

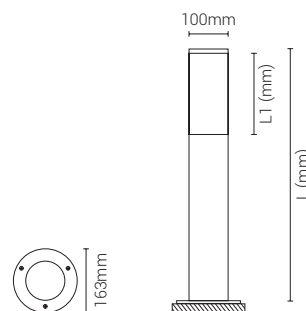

2049 | IK08 | IP65 | E27 | PL-L LED

Código	L (mm)	L1 (mm)	Fluxo/Pot. (aprox.)	€
2049.100.xTX	400	175	E27	171,01
2049.100.xOX	400	175	E27	161,11
2049.100.8TX	400	175	E27	196,13
2049.100.8OX	400	175	E27	187,32
2049.110.xTL	400	175	E27 10W - 825 lm	187,91
2049.110.xOL	400	175	E27 10W - 825 lm	178,01
2049.110.8TL	400	175	E27 10W - 825 lm	213,04
2049.110.8OL	400	175	E27 10W - 825 lm	204,23
2049.116.xTL	535	310	PL-L LED 16W - 2100lm	243,42
2049.116.xOL	535	310	PL-L LED 16W - 2100lm	229,11
2049.116.8TL	535	310	PL-L LED 16W - 2100lm	269,63
2049.116.8OL	535	310	PL-L LED 16W - 2100lm	255,32

3000K | 4000K

1 2 7 8 9 0 T

2050 | IK08 | IP65 | E27 | PL-L LED

Código	L (mm)	L1 (mm)	Fluxo/Pot. (aprox.)	€
2050.100.xTX	600	175	E27	200,32
2050.100.xOX	600	175	E27	191,51
2050.100.8TX	600	175	E27	209,31
2050.100.8OX	600	175	E27	200,49
2050.110.xTL	600	175	E27 10W - 825 lm	217,23
2050.110.xOL	600	175	E27 10W - 825 lm	208,41
2050.110.8TL	600	175	E27 10W - 825 lm	226,22
2050.110.8OL	600	175	E27 10W - 825 lm	217,40
2050.116.xTL	735	310	PL-L LED 16W - 2100lm	273,82
2050.116.xOL	735	310	PL-L LED 16W - 2100lm	259,51
2050.116.8TL	735	310	PL-L LED 16W - 2100lm	282,81
2050.116.8OL	735	310	PL-L LED 16W - 2100lm	268,50

3000K | 4000K

1 2 7 8 9 0 T

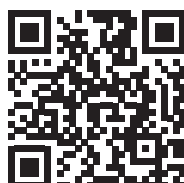



2051

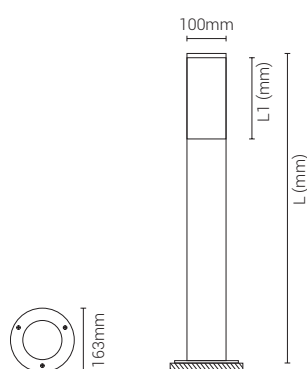

2052

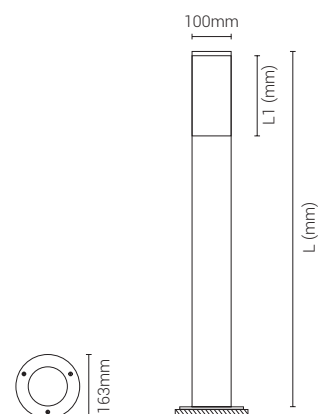

2051 | IK08 | IP65 | E27 | PL-L LED

Código	L (mm)	L1 (mm)	Fluxo/Pot. (aprox.)	€
2051.100.xTX	1000	175	E27	234,50
2051.100.xOX	1000	175	E27	225,69
2051.100.8TX	1000	175	E27	245,85
2051.100.8OX	1000	175	E27	237,03
2051.110.xTL	1000	175	E27 10W - 825 lm	251,41
2051.110.xOL	1000	175	E27 10W - 825 lm	242,60
2051.110.8TL	1000	175	E27 10W - 825 lm	262,76
2051.110.8OL	1000	175	E27 10W - 825 lm	253,94
2051.124.xTL	1235	410	PL-L LED 24W - 3200lm	310,95
2051.124.xOL	1235	410	PL-L LED 24W - 3200lm	296,64
2051.124.8TL	1235	410	PL-L LED 24W - 3200lm	322,30
2051.124.8OL	1235	410	PL-L LED 24W - 3200lm	307,98

3000K | 4000K

1 2 7 8 9 0 T

2052 | IK08 | IP65 | E27 | PL-L LED

Código	L (mm)	L1 (mm)	Fluxo/Pot. (aprox.)	€
2052.100.xTX	1200	175	E27	264,87
2052.100.xOX	1200	175	E27	256,00
2052.100.8TX	1200	175	E27	291,03
2052.100.8OX	1200	175	E27	282,21
2052.110.xTL	1200	175	E27 10W - 825 lm	281,78
2052.110.xOL	1200	175	E27 10W - 825 lm	272,91
2052.110.8TL	1200	175	E27 10W - 825 lm	307,93
2052.110.8OL	1200	175	E27 10W - 825 lm	299,12
2052.124.xTL	1435	410	PL-L LED 24W - 3200lm	341,32
2052.124.xOL	1435	410	PL-L LED 24W - 3200lm	327,01
2052.124.8TL	1435	410	PL-L LED 24W - 3200lm	367,47
2052.124.8OL	1435	410	PL-L LED 24W - 3200lm	353,16

3000K | 4000K

1 2 7 8 9 0 T





2053

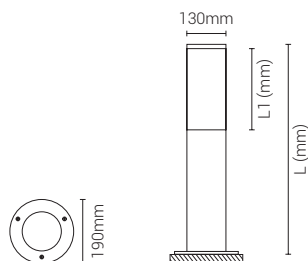
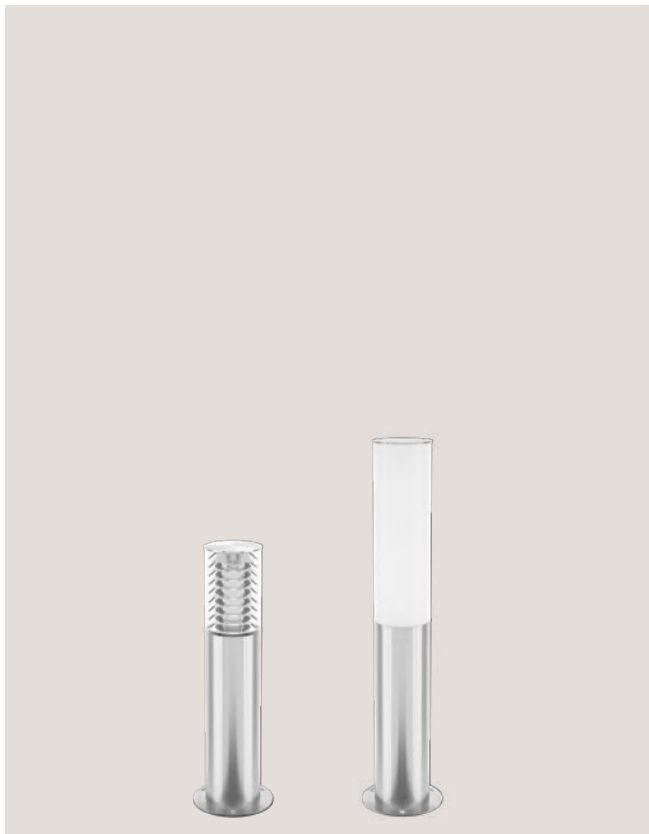

2054

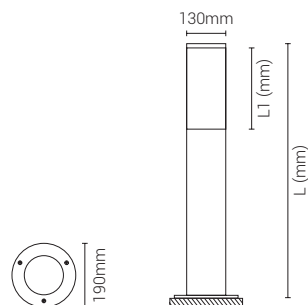

2053 IK08 IP65 E27 PL-L LED				
Código	L (mm)	L1 (mm)	Fluxo/Pot. (aprox.)	€
2053.100.xTX	600	175	E27	217,60
2053.100.xOX	600	175	E27	204,28
2053.100.8TX	600	175	E27	226,88
2053.100.8OX	600	175	E27	213,56
2053.110.xTL	600	175	E27 10W - 825 lm	234,51
2053.110.xOL	600	175	E27 10W - 825 lm	221,19
2053.110.8TL	600	175	E27 10W - 825 lm	243,79
2053.110.8OL	600	175	E27 10W - 825 lm	230,47
2053.124.xTL	835	410	PL-L LED 24W - 3200lm	300,04
2053.124.xOL	835	410	PL-L LED 24W - 3200lm	273,51
2053.124.8TL	835	410	PL-L LED 24W - 3200lm	309,32
2053.124.8OL	835	410	PL-L LED 24W - 3200lm	282,79

3000K | 4000K

1 2 7 8 9 0 T

2054 IK08 IP65 E27 PL-L LED				
Código	L (mm)	L1 (mm)	Fluxo/Pot. (aprox.)	€
2054.100.xTX	1000	175	E27	285,53
2054.100.xOX	1000	175	E27	272,20
2054.100.8TX	1000	175	E27	334,63
2054.100.8OX	1000	175	E27	321,31
2054.110.xTL	1000	175	E27 10W - 825 lm	302,44
2054.110.xOL	1000	175	E27 10W - 825 lm	289,11
2054.110.8TL	1000	175	E27 10W - 825 lm	351,54
2054.110.8OL	1000	175	E27 10W - 825 lm	338,22
2054.124.xTL	1235	410	PL-L LED 24W - 3200lm	367,97
2054.124.xOL	1235	410	PL-L LED 24W - 3200lm	341,44
2054.124.8TL	1235	410	PL-L LED 24W - 3200lm	417,07
2054.124.8OL	1235	410	PL-L LED 24W - 3200lm	390,54

3000K | 4000K

1 2 7 8 9 0 T





2055

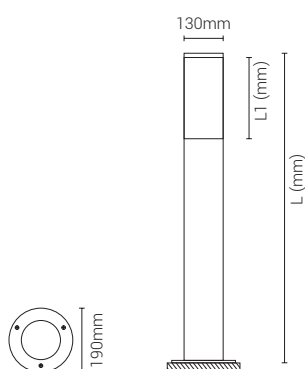

2056

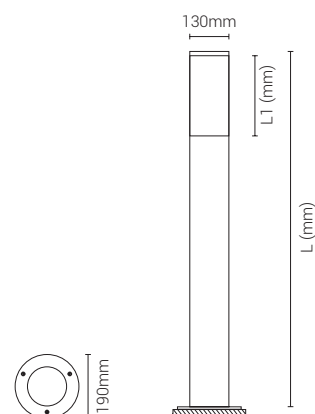
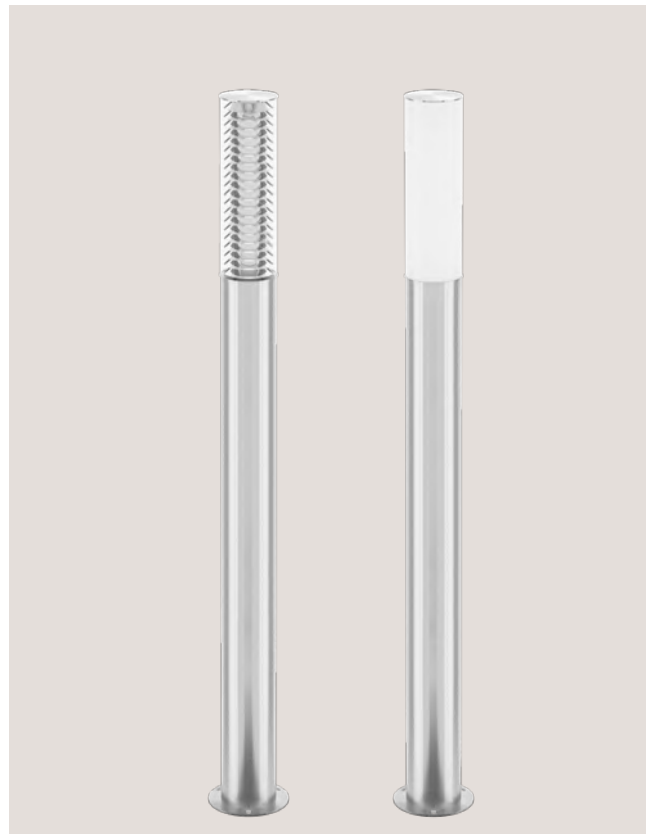

2055 | IK08 | IP65 | PL-L LED

Código	L (mm)	L1 (mm)	Fluxo/Pot. (aprox.)	€
2055.124.xTL	1435	410	PL-L LED 24W - 3200lm	474,09
2055.124.xOL	1435	410	PL-L LED 24W - 3200lm	447,56
2055.124.8TL	1435	410	PL-L LED 24W - 3200lm	505,86
2055.124.8OL	1435	410	PL-L LED 24W - 3200lm	479,33

3000K | 4000K

1 2 7 8 9 0 T

2056 | IK08 | IP65 | PL-L LED

Código	L (mm)	L1 (mm)	Fluxo/Pot. (aprox.)	€
2056.124.xTL	1860	410	PL-L LED 24W - 3200lm	513,98
2056.124.xOL	1860	410	PL-L LED 24W - 3200lm	487,45
2056.124.8TL	1860	410	PL-L LED 24W - 3200lm	592,64
2056.124.8OL	1860	410	PL-L LED 24W - 3200lm	566,11

3000K | 4000K

1 2 7 8 9 0 T

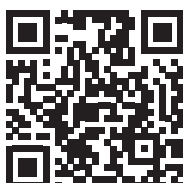



2546

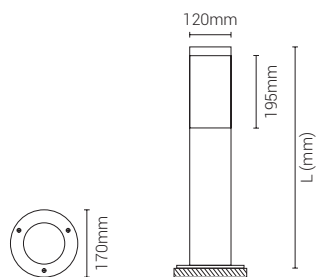

2547

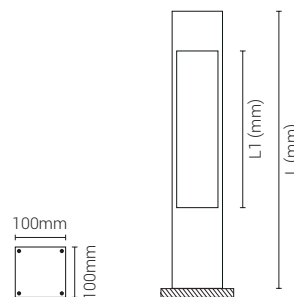

2546 | IK08 | IP65 | LED

Código	L (mm)	Fluxo/Pot. (aprox.)	€
2546.050.7TL	500	20W - 1400 lm	110,00
2546.100.7TL	1000	20W - 1400 lm	132,00

3000K | 4000K



2547 | IK08 | IP54 | COB

Código	L (mm)	L1 (mm)	Fluxo/Pot. (aprox.)	€
2547.070.xFL	700	300	10W - 1700 lm	177,11
2547.100.xFL	1000	600	10W - 1700 lm	215,19

3000K | 4000K







2501

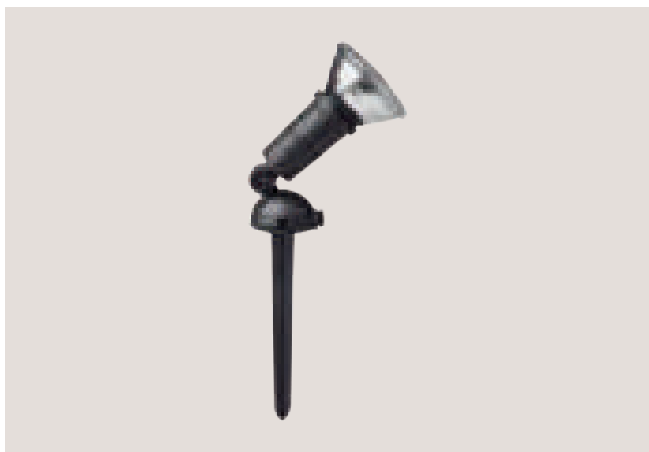

2501 IP55 E27		
Código	Fluxo/Pot. (aprox.)	€
2501.100.xXX	E27	15,24

1 2 9 10

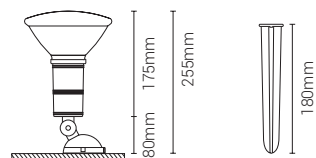

2502



2502 IP65 LED GU10		
Código	Fluxo/Pot. (aprox.)	€
2502.100.xTX	GU10	35,95
2502.105.xTL	5W - 380 lm	42,13

2700K | 3000K | 4000K

1 2 9 T

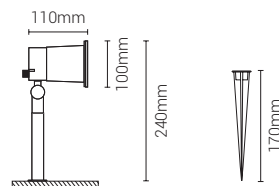

2503



2503 IK03 IP65 LED GU10		
Código	Fluxo/Pot. (aprox.)	€
2503.100.8TX	GU10	151,76
2503.105.8TL	5W - 380 lm	157,95

2700K | 3000K | 4000K

8 T

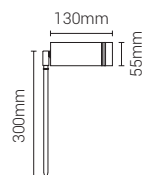



2504



2504 | IK06 | IP65 | COB

Código	Fluxo/Pot. (aprox.)	€
2504.107.7PL	7W - 650 lm	72,36

3000K | 4000K

7 P

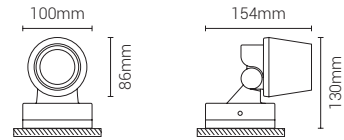

2505



2505 | IK06 | IP65 | COB

Código	Fluxo/Pot. (aprox.)	€
2505.118.7PL	15W - 1750 lm	124,36

3000K | 4000K

7 P

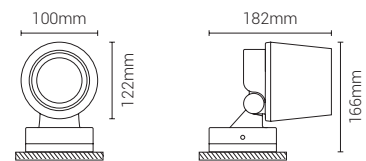

Acessórios



2500
6,91€
Espeto como opção





2506

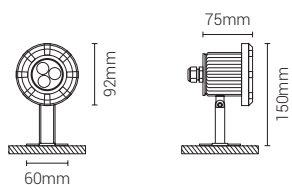

2507

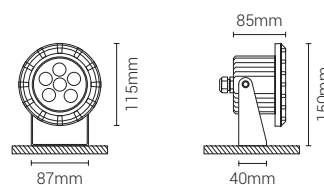

2506 IK08 IP65 LED		
Código	Fluxo/Pot. (aprox.)	€
2506.103.7TL	3,6W - 350 lm	68,00

3000K | 4000K



2507 IK06 IP65 LED		
Código	Fluxo/Pot. (aprox.)	€
2507.107.7TL	7,2W - 650 lm	88,00

3000K | 4000K





2508

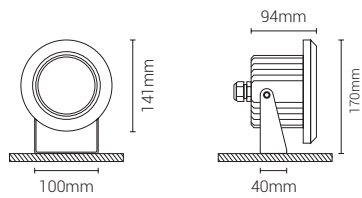

2509

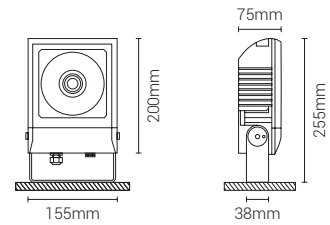

2508 | IK06 | IP65 | LED

Código	Fluxo/Pot. (aprox.)	€
2508.111.7TL	11W - 1040 lm	118,55

3000K | 4000K



2509 | IK06 | IP65 | LED

Código	Fluxo/Pot. (aprox.)	€
2509.122.7PL	22W - 2020 lm	155,27

3000K | 4000K





Acessórios

Caixas Alvenárias

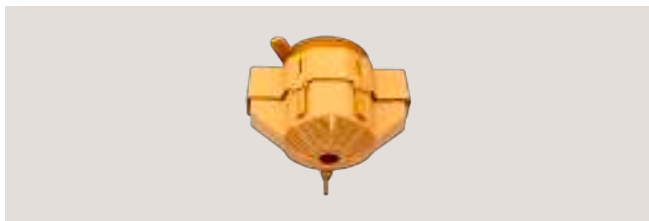

Caixas Alvenárias		
Código	Designação	€
9901.000.XXX	Caixa p/ projetores D=25mm a 100mm	6,75
9918.PLA.RED	Caixa p/ projetores D=80mm a 220mm - Redondo	14,95
9931.PLA.QUA	Caixa p/ projetores D=80mm a 220mm - Quadrado	14,95
9071.000.XXX	Caixa p/ projetores 1031, 1061, 1071, 1081, 6031, 6061, 6071, 6081	10,35
9918.000.XXX	Caixa p/ projetores 7018	19,90
9972.000.XXX	Caixa p/ projetores 7062	21,27
9973.000.XXX	Caixa p/ projetores 1007, 7063	20,71

Cabos de Alimentação



5084.xAx		
Código	Designação	€
5084.3A2	Cabo de Alimentação 3 Condutores 2 Metros	4,51
5084.3A3	Cabo de Alimentação 3 Condutores 3 Metros	5,81
5084.3A4	Cabo de Alimentação 3 Condutores 4 Metros	7,11
5084.3A5	Cabo de Alimentação 3 Condutores 5 Metros	8,41
5084.5A2	Cabo de Alimentação 5 Condutores 2 Metros	10,26
5084.5A3	Cabo de Alimentação 5 Condutores 3 Metros	14,43
5084.5A4	Cabo de Alimentação 5 Condutores 4 Metros	18,61
5084.5A5	Cabo de Alimentação 5 Condutores 5 Metros	22,78

Outras medidas sob consulta.

Sistema Repicagem

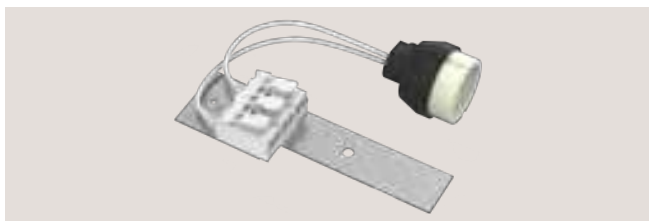

Sistema Repicagem		
Código	Designação	€
9903.000.XXX	Sistema Repicagem série 6000	1,73

Cabos de Suspensão



5084.COx		
Código	Designação	€
5084.CO2	Cabo de Suspensão 2 metros	5,69
5084.CO3	Cabo de Suspensão 3 metros	6,06
5084.CO4	Cabo de Suspensão 4 metros	6,43
5084.CO5	Cabo de Suspensão 5 metros	6,80

Transformadores LED



Transformadores LED				
Código	Designação	Nº projetores	Medidas (mm aprox.)	€
0101.103.XXX	LED 3W - 350 mA	2	55x27x22	7,72
0101.106.XXX	LED 6W - 350 mA	4	70x35x20	11,43
0101.115.XXX	LED 15W - 350 mA	11	123x45x20	13,29
0101.120.XXX	LED 20W - 350 mA	15	123x46x20	25,65
0102.103.XXX	LED 3W - 700 mA	1	55x27x22	9,89
0102.106.XXX	LED 6W - 700 mA	2	70x35x20	10,50
0102.115.XXX	LED 15W - 700 mA	5	123x45x20	13,50
0102.120.XXX	LED 20W - 700 mA	7	123x46x20	26,53

Esquema Elétrico

Touch/Dim

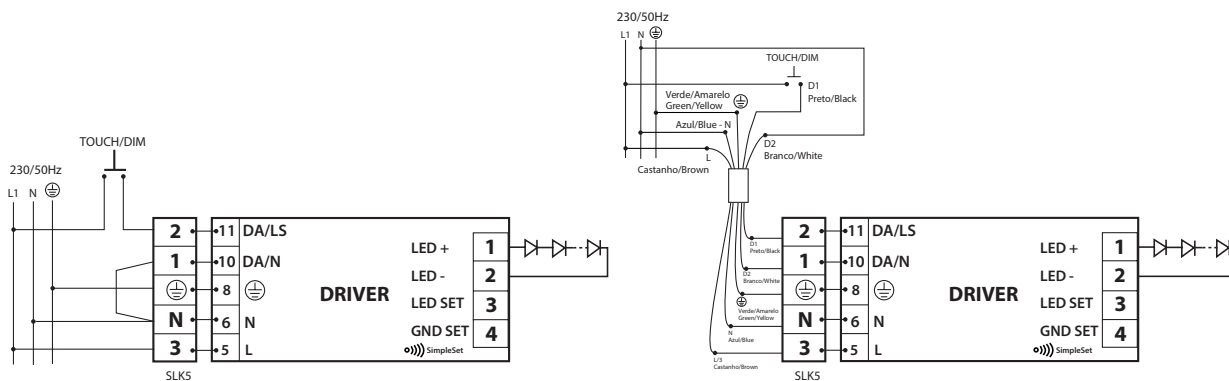

Dali

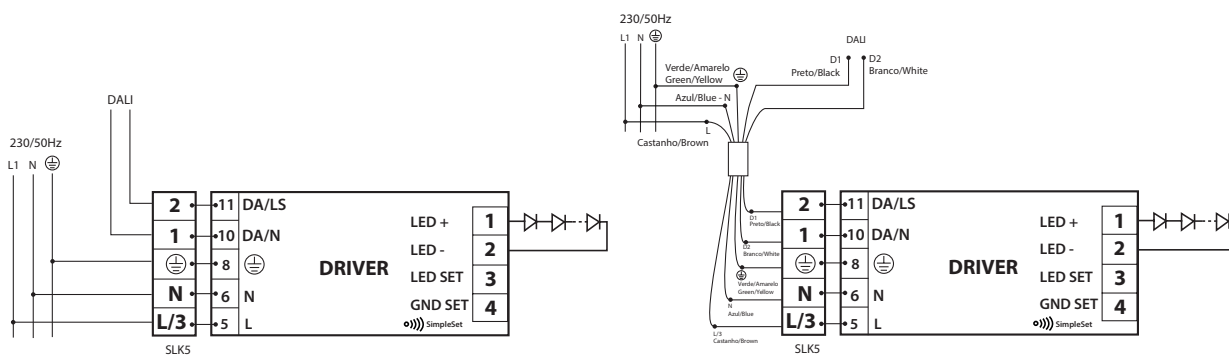

1-10V

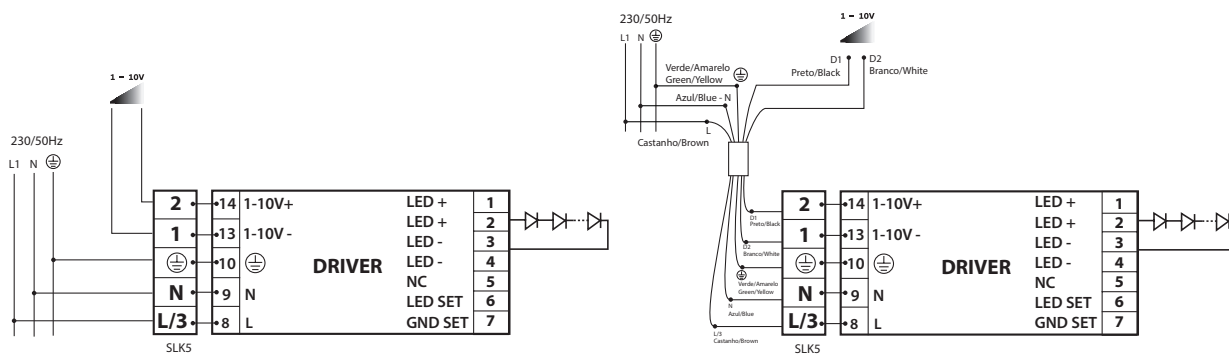

On/Off

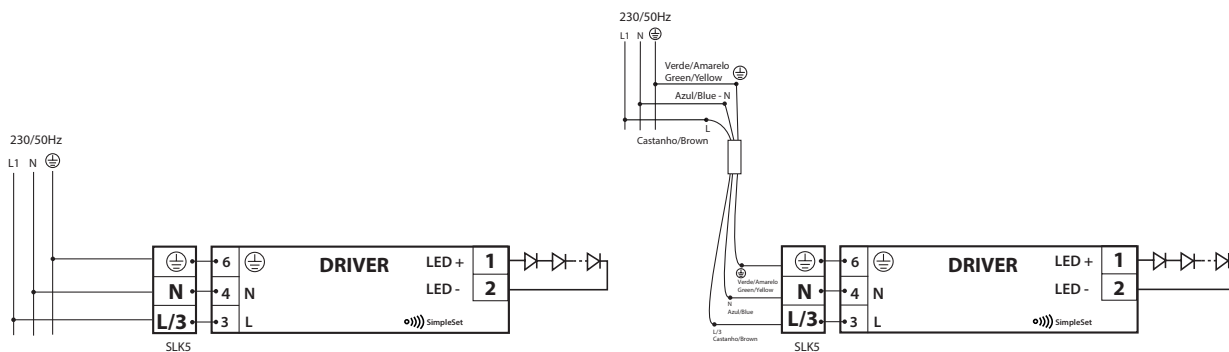



Índice Numérico

Código	Página
Série 1000	
1001	134
1001 V	134
1002	134
1002 V	134
1003	130
1004	137
1007.100	148
1007.200	148
1007.300	148
1007.400	148
1008.100	146
1008.200	146
1008.300	146
1008.400	146
1009	136
1010	156
1011	152
1011 V	152
1012	152
1012 V	152
1013	156
1014	157
1020	156
1021	153
1022	153
1025	153
1026	153
1027	137 183
1028	158 184
1031.100	150
1031.200	150
1032	150
1033	150
1037.100	149
1037.200	149
1037.300	149
1037.400	149
1038.100	147
1038.200	147
1038.300	147
1038.400	147
1039.100	145
1039.200	145
1039.300	145
1039.400	145
1041	135
1042	135
1051	135
1052	135
1061	154
1071	154
1076	133
1081.100	144
1081.200	144
1081.300	144
1081.400	144
1084	151
1086	154
1088	136
1089	138
1091	136
1094	139
1095	139
1096	139
1097	139
1098.100	161
1098.200	161
1098.300	161
1098.400	161
1199.100	173
1199.200	173
1199.300	173
1199.400	173
1501	133
1502	130
1503	133
1504	157
1505	130
1506	131

Código	Página
1507	131
1508	131
1509	131
1510	130
1511	157
1512	157
1513	156
1514	133
1515.100	142
1515.200	142
1515.300	142
1515.400	142
1515.500	143
1516.400	143
1516.900	143
1524.100	164
1524.200	164
1524.300	164
1524.400	164
1524.500	165
1525.400	165
1525.900	165
Série 2000	
2001	194
2002	194
2005.101	199
2005.102	199
2005.103	199
2009	194
2010	195
2011	194
2012	195
2013	195
2014	195
2015	196
2016	196
2017	197
2018	197
2019	193
2020	213
2028	204
2029	204
2030	207
2031	207
2032	207
2033	211
2034	211
2035	211
2036	210
2037	210
2038	210
2039	207
2040	179 212
2041	213
2042	230
2043	230
2044	231
2045	231
2049	232
2050	232
2051	233
2052	233
2053	234
2054	234
2055	235
2056	235
2057	185
2058	185
2059	185
2060	186
2061	186
2062	186
2063	206
2064	206
2065	206
2066	205
2067	205
2071	202
2072	203
2073	202

Código	Página
2074	198
2075	212
2076	212
2077	212
2080	187
2081	202
2082	203
2083	187
2085	203
2086	203
2087	204
2088	204
2090	202
2501	238
2502	238
2503	238
2504	239
2505	239
2506	240
2507	240
2508	241
2509	241
2516	196
2517	197
2522	198
2523	198
2524	198
2525	191
2526	193
2527	191
2528	193
2530	208
2531	208
2532	208
2533	208
2546	236
2547	236
2560	185
2561	187
2562	187
2566	213
2568	205
2569	205
Série 3000	
3001	217
3002	219
3003	217
3004	218
3005	216
3006	224
3007	218
3008	219
3010	219
3011	225
3012	225
3014	217
3015	225
3016	219
3017	226
3018	191 218
3019	193 225
3021	221
3022	220
3023	220
3024	220
3025	221
3026	217
3027	218
3030	227
3031	226
3042	221
3052	226
3054	222
3055	222
3056	227
3057	223
3059	223
3063	197 228
3064	197 228
3065	228

Código	Página
3091	190 216
3092	192 224
3093	190 216
3094	192 224
3095	191 222
3096	190 216
3097	192 224
Série 4000	
4001	180
4002	178
4004	179
4005	179
4006	178
4007	178
4008	178
4009	179
4011	62
4012	63
4013	63
4018	78
4018 LED	78
4020	55
4021	52
4022	53
4023	53
4024	54
4025	27
4026	24
4027	26
4031	16
4032	18
4033	19
4036	14
4041	32
4042	34
4043	35
4046	30
4051	40
4052	42
4053	43
4056	46
4057	46
4060	44
4061	45
4062	47
4064	74
4065	70
4066	75
4067	71
4068	74
4069	70
4070	75
4071	71
4077	176
4078	176
4079	176
4091	158 177
4092	132 177
4501	56
4512	58
4515	64
4516	65
4517	59
4520	50
4521	50
4522	60
4524	20
4525	20
4526	22
4527	61
4530	12
4531	12
4536	52
4540	28
4541	28
4546	54
4550	36
4551	36
4556	38
4560	45

Código	Página
4562	47
4564	73
4565	69
4566	44
4567	68
4568	73
4569	69
4571	68
4572	72
4573	72
Série 5000	
5001	81
5002	81
5004	90
5005	108
5006	81
5007	91
5008	111
5009	111
5010	87
5011	87
5015	88
5016	88
5024	98
5025	98
5026	99
5027	99
5030	126
5031	126
5032	126
5033	126
5044	127
5045	127
5046	127
5050	48
5051	48
5074	122
5075	123
5076	122
5077	123
5078	122
5079	123
5080	112
5081	112
5082	115
5083	115
5084.S	118
5084.E	118
5085	113
5086	114
5087	114
5088	113
5096	117
5097	116
5098	116
5099	117
5501	80
5502	80
5503	111
5504	92
5505	108
5506	109
5507	94
5508	108
5509	108
5510	86
5511	86
5512	89
5513	89
5514	92
5517	94
5520	97
5521	97
5524	100
5525	100
5526	101
5527	101
5528	100
5529	101
5530	90

Código	Página
5531	91
5532	110
5533	110
5534	110
5535	110
5536	96
5537	96
5541	91
5544	92
5547	94
5550	104
5551	104
5552	104
5570	124
5571	124
5572	124
5574	122
5575	123
5576	122
5577	123
5578	122
5579	123
5601	80
Série 6000	
6001	134
6001 V	134
6002	134
6002 V	134
6008.100	146
6008.200	146
6008.300	146
6008.400	146
6009	136
6010	156
6011	152
6011 V	152
6012	152
6012 V	152
6013	156
6014	157
6015	130
6016	137
6020	156
6021	153
6022	153
6023	137 183
6024	137 183
6025	153
6026	153
6027	137 183
6028	158 184
6029	151
6031.100	150
6031.200	150
6032	150
6033	150
6034	132
6036	136
6037.100	160
6037.200	160
6037.300	160
6037.400	160
6038.100	147
6038.200	147
6038.300	147
6038.400	147
6039.100	145
6039.200	145
6039.300	145
6039.400	145
6041	135
6042	135
6051	135
6052	135
6061	154
6071	154
6074	139
6075	139
6080.100	159
6080.200	159

Código	Página
6080.300	159
6080.400	159
6081.100	144
6081.200	144
6081.300	144
6081.400	144
6086	154
6088	136
6089	138
6091	168
6092	168
6093	170
6094	170
6097.100	167
6097.200	167
6097.300	167
6098.100	166
6098.200	166
6098.300	166
6107.100	148
6107.200	148
6107.300	148
6107.400	148
6137.100	149
6137.200	149
6137.300	149
6137.400	149
6196	139
6197	139
6198.100	161
6198.200	161
6198.300	161
6198.400	161
6280	112
6281	112
6282	115
6283	115
6285	

Esta tabela de preços inclui QR Codes, facilitando e expandindo assim o acesso a diversas características sobre o produto que pretende consultar.

Para isso siga os passos seguintes:

1. Aceda à sua *Google Play* ou *App Store*.



2. Escreva na barra de pesquisa "QR Code".

3. Selecione uma das aplicações e clique em "Instalar".

4. Assim que terminar a instalação, clique em "Abrir".

5. Direcione a câmara do seu telemóvel para o QR Code referente ao produto que pretende mais informação.

As imagens apresentadas são meramente ilustrativas. As medidas dos desenhos técnicos podem oscilar ± 3 milímetros.

Os valores de potência e de fluxo luminoso descritos são sempre os valores indicados pelo fornecedor da fonte luminosa padrão.

As informações contidas nesta tabela referem-se à data de impressão, não são vinculativas e devem ser usadas apenas para fins informativos.

Reservamos o direito de fazer alterações aos nossos produtos, a qualquer momento. Esta tabela anula e substitui anteriores edições e pode ser alterada sem aviso prévio.

tromilux

Rotunda do Parque Tecnológico, 164

4410-137 S. Félix da Marinha

V.N.Gaia, Portugal

geral@tromilux.com

info@tromilux.com

+351 227 334 040

+351 227 347 524

+351 227 532 167

 tromilux.com

 blog.tromilux

 /tromilux

 @tromilux

 /company/tromilux

 /tromilux_official/

