



Unica

Catalog 2023



Unica Studio

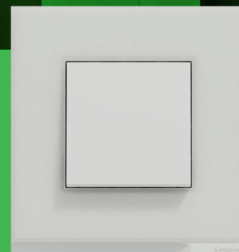

Unica Pure



Unica Pro

se.com/unica



General content

Presentation	4
Unica Inserts	48
Unica Inserts with Fixing Frame	70
Unica Inserts with Fixing Frame and claws	82
Unica Complete offer: Inserts with Fixing Frame and Cover Frame	88
Unica Installation: Fixing Frame and Box	92
Unica Cover Frames	98
Unica Wiser	108
Unica KNX	116
Unica Antibacterial offer	120
Unica System+	134
Unica Technical Information	140
Unica Index	162

Deliver the exceptional, every day

Wiring devices may not be as top-of-mind as other elements of interior décor, but they have a significant impact on comfort and convenience in living and working spaces. To fulfill that potential, Unica products are designed to be:

Everyday beautiful, adding style to interiors with elegant design.

Everyday simple, enabling quick and easy mounting through clever product design.

Everyday your way, providing great flexibility of application and use through modularity and wireless control.

Quality that lasts

Manufactured in Schneider Electric's Puente la Reina smart factory in Spain, a center of excellence and expertise for wiring devices, Unica products meet the highest quality standards. They deliver the high reliability, durability, and aesthetics that are signature for the brand.





Sustainable through the lifecycle



At the design stage, the devices are made easily dismountable to facilitate recycling.



At the manufacturing stage, more than 50% of the raw material used for our devices comes from recycled sources and 100% of the material is internally reused to generate zero waste.



At the packaging stage, we're taking steps to optimize product packaging sizes and materials to avoid waste.



Bearing the Green Premium ecolabel, Unica products exceed the sustainability standards of the industry.

EVERYDAY BEAUTIFUL

Wiring devices that complement any lifestyle

With user-friendly designs and a broad assortment of functions, Unica products help make everyday home life more comfortable and convenient.

Crafted with the latest aesthetic trends in mind – with an array of sophisticated materials including metal, slate, and glass – Unica products are made to win hearts and turn heads.

For clients interested in smart home technology, Unica devices connectivity-ready. They're compatible with Wiser, our smart, sustainable home technology, and can be controlled with KNX automation devices.



Workspaces that work

Creating a fully functional workspace requires a bit of imagination and creatively designed products. Unica - together with Unica System+ and OptiLine 45 - is ready for the challenge.

Whether your customer is working in a small studio or a massive office building, with our workspace-dedicated portfolio you can create spaces that are fully functional, from floor to ceiling.

Unica, Unica System+, and OptiLine 45 bring you the flexibility and ingenuity to elevate offices from work-ready to future-ready.

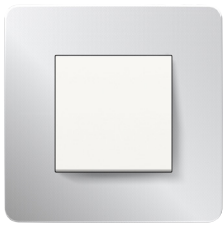

Wiring devices

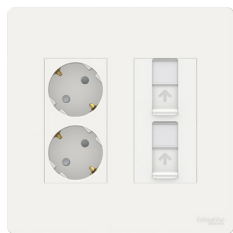

Horizontal and vertical workstations

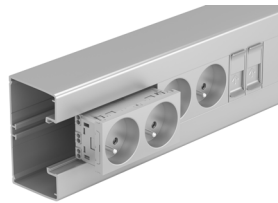

Trunking

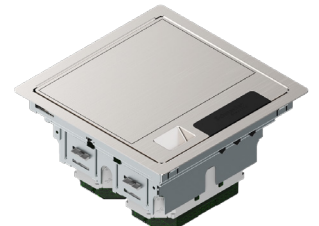

Floor sockets and boxes



Stand-alone desk units



Modular desk units



Poles and posts

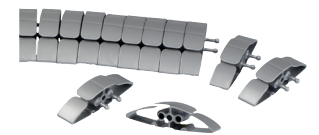

Cable management



EVERYDAY BEAUTIFUL

Unica Studio

Add character to interiors with signature rounded frames.



Enjoy timeless, universal design

The Unica Studio range gives you a selection of frames to easily match different types of interiors, from minimalist to traditional. Made from high-performance thermoplastic, they're robust and long lasting.

The Unica Studio range comes in two versions. Single-volume frames are available in solid colors (white, beige, aluminum, and anthracite).

The double-skin version has frames composed of a colored or metal layer over a white, beige, or anthracite base (see Unica Studio Color and Unica Studio Metal).

Single-volume frames

The white and beige frames have a mirror-polished surface for a nice glossy finish and are a perfect fit for lighter interiors with brighter wall colors.

The anthracite and aluminum finishings work for darker interiors or as bold color accents. The anthracite frames have a soft-touch perception, while the aluminum ones add a bit of shine.

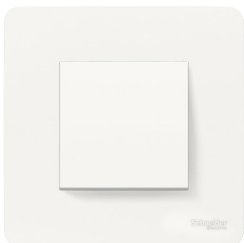

Unica Studio
White

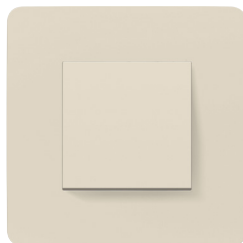

Unica Studio
Beige



Unica Studio
Anthracite

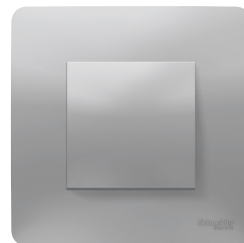

Unica Studio
Aluminium

EVERYDAY BEAUTIFUL

Unica Studio Color

Invigorate any room with a splash of color.

With nine colors available – from soft and light, to bold and lively – the Unica Studio Color range offers a hue to complement any décor or style. Add to that a modern shape and smooth, curved surface, and you get perfect switches for energetic interiors.

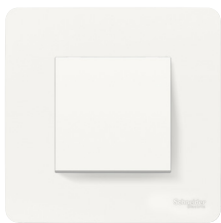

Unica Studio Color
White

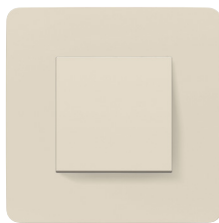

Unica Studio Color
Beige

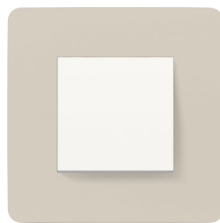

Unica Studio Color
Light grey

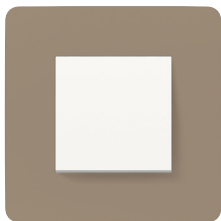

Unica Studio Color
Taupe

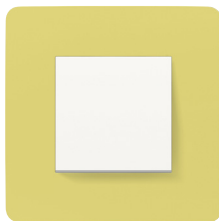

Unica Studio Color
Light green

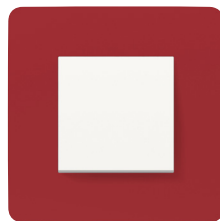

Unica Studio Color
Red

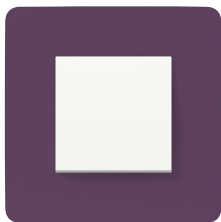

Unica Studio Color
Plum

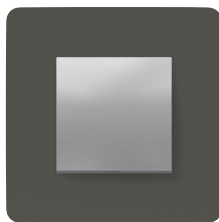

Unica Studio Color
Dark grey

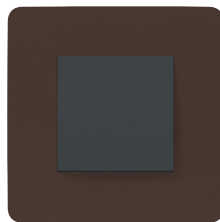

Unica Studio Color
Chocolate

Unica Studio Color double-skin frames have metallic particles added to the two layers of paint to add depth to the colors and create a more dynamic appearance.

EVERYDAY BEAUTIFUL

Unica Studio Outline

Add a dash of character.

At first glance, Unica Studio Outline frames play it safe, with neutral white frames and switches. A closer look reveals a flirtation of color. Ten outline colors, from vibrant yellow to moderate grey and taupe, help elevate interior designs while keeping them well balanced.



Unica Studio Outline
White

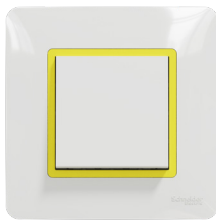

Unica Studio Outline
Yellow



Unica Studio Outline
Red



Unica Studio Outline
Plum



Unica Studio Outline
Chocolate



Unica Studio
Outline
Light grey



Unica Studio Outline
Grey



Unica Studio Outline
Aluminium



Unica Studio Outline
Beige



Unica Studio Outline
Anthracite

EVERYDAY BEAUTIFUL

Unica Studio Metal

Give home interiors a modern edge.

The Unica Studio Metal range features five ultra-modern metal finishes that combine quality and robustness with an elegant design.

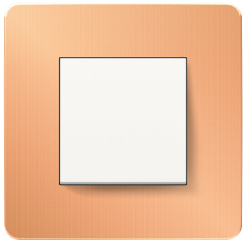

Unica Studio Metal
Copper

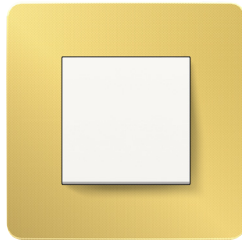

Unica Studio Metal
Gold

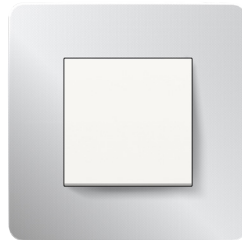

Unica Studio Metal
White aluminium

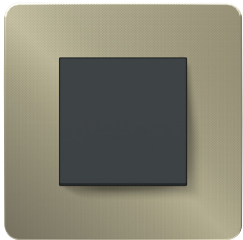

Unica Studio Metal
Bronze

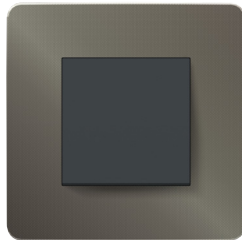

Unica Studio Metal
Dark aluminium

The frames are made of sheet metal with an anodized finishing to create a bright smooth surface. An additional high-resistance treatment helps ensure a lasting look by minimizing the impact of aging and environmental conditions.

EVERYDAY BEAUTIFUL

Unica Pure

When it comes to elegance and sophistication, there's no match for Unica Pure.

With a selection of faceplates manufactured from exquisite materials – wood, slate, glass, rubber, metal, Unica Pure offers an array of finishes for premium interiors.

The sleek, clean frame design highlights a faceplate that rests on a sculpted ledge like a piece of art. The supporting surface is white or anthracite, matching the tone of the faceplate.

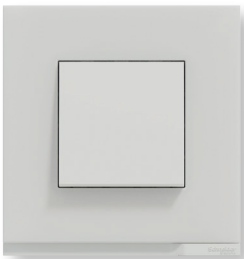

Unica Pure
Translucid white



Unica Pure
Glass frosted black



Unica Pure
Glass frosted white

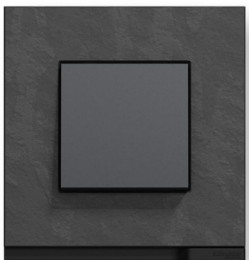

Unica Pure
Slate

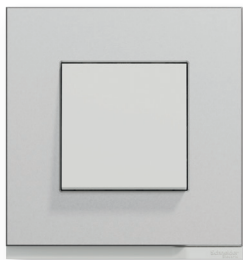

Unica Pure
Aluminium

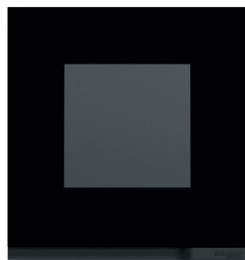

Unica Pure
Rubber



Unica Pure
Nordic wood



Unica Pure
Oak wood

EVERYDAY BEAUTIFUL

Unica Pro

Achieve the perfect balance.

The Unica Pro range provides the perfect balance of style and functionality. Its signature design, with a ring surrounding the frame, makes the frames stand out from the wall and adds a smooth, light perception to them.

The inclined top and bottom edges of the frame prevent the accumulation of dust and make it difficult for non-professionals to remove the switch from the wall, helping to improve safety in the workplace.

Available in white, aluminum, and anthracite, Unica Pro frames satisfy all essential style needs.



Unica Pro
White



Unica Pro
Aluminium



Unica Pro
Anthracite



Antibacterial

The Unica Pro range also includes a white antibacterial finish for those mindful of hygiene and safety.

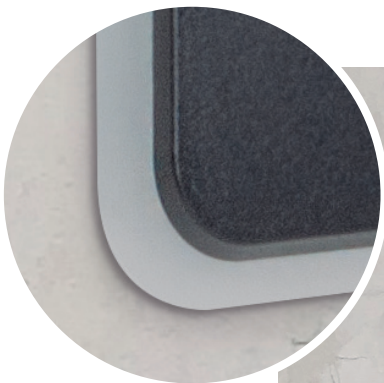





Antibacterial for greater hygiene and safety

For areas of homes and offices where hygiene is a concern – like a baby’s room, the kitchen, or the common spaces – the Unica range provides devices with antibacterial properties.

To enable these properties, the raw plastic material has been enriched with silver ions. All external surfaces of devices are made from antibacterial material that’s fully compliant with the latest international standard, ISO 22196:2011*.

87%

of tested bacteria gone after 8 hours*

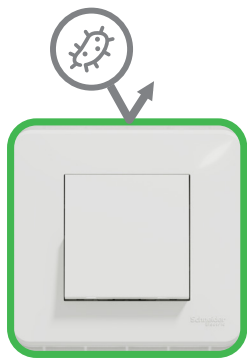

Silver ion technology ✓

Silver ions act as a long-term barrier against bacteria, stopping their growth and spread.



22196:2011

*Testing done by an external laboratory. As per ISO 22196:2011 requirement, the microorganisms tested were Escherichia coli and Staphylococcus aureus.

Unique in the market, the antibacterial range includes a wide variety of functions needed in an office, from switches and sockets, to workstations and connected devices. What’s more, you don’t have to compromise on aesthetics for greater safety. The range features the same elegant design as the regular white Unica devices.

Other functions also available in the antibacterial finishing:



Antibacterial

All products have the antibacterial logo visible.



Switch



Universal dimmer

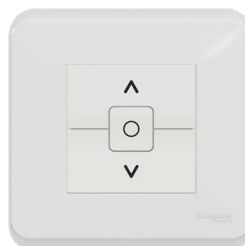

Shutter control

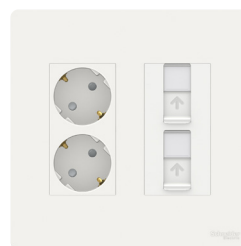

Flush mounting workstation



Side earth socket

Convenient ways to personalize homes

The new Unica range includes all the wiring devices you need to enhance the style, comfort, and safety of your customers' homes. From lighting control to entertainment system connections and smart home functions, Unica is ready to meet your clients' current and future needs.

Lighting control

Automatic light control with motion sensors improves safety and energy efficiency.

Rotary and pushbutton dimmers, compatible with both conventional and LED lighting, help easily adjust the ambiance.

Connectivity-ready switches, dimmers, and motion sensors can be easily integrated with the Wisier smart home system. A connected wireless switch can be used with Wisier to control lights and shutters from anywhere.

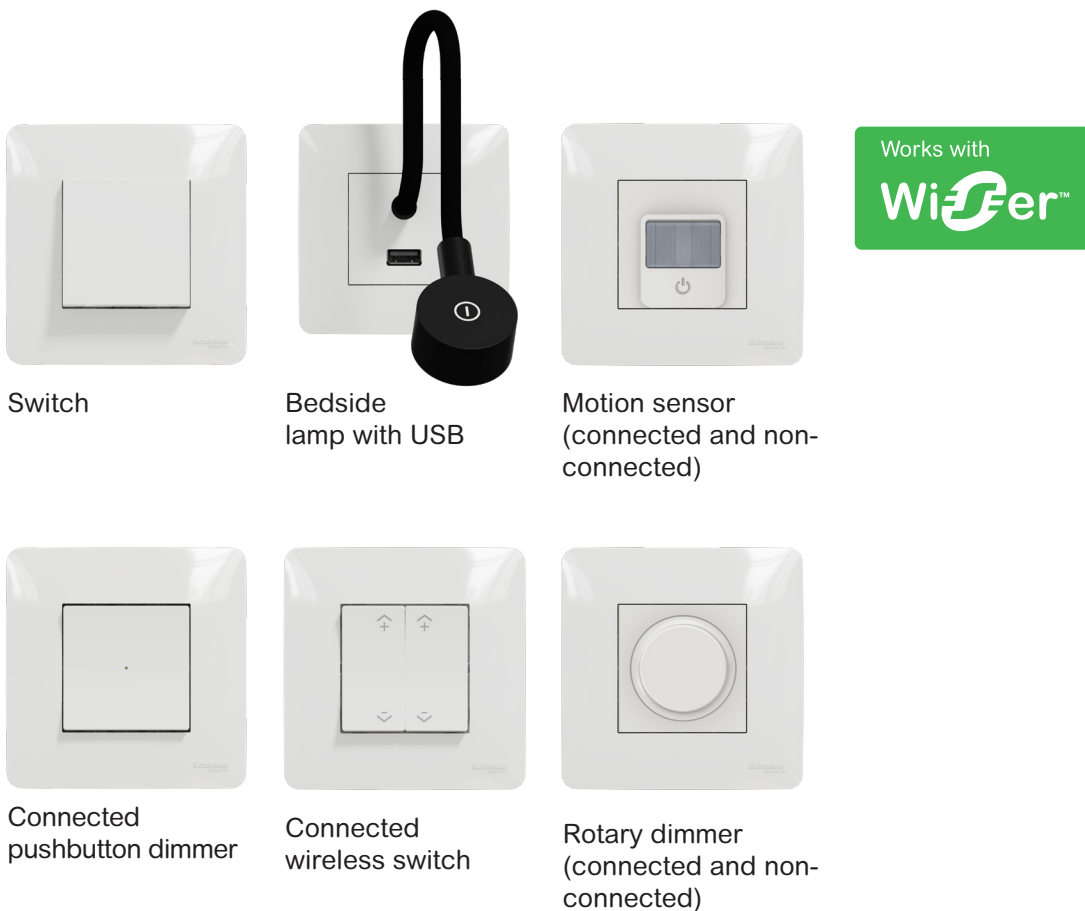

EVERYDAY YOUR WAY

Shutter control

Manual-at-a-push control or fully automatic via a time controller increases convenience.

Shutters can also protect home interiors from excessive sunlight and help discourage unwanted interest from strangers.

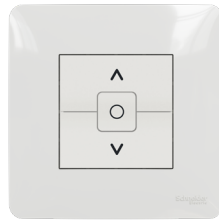

Shutter control

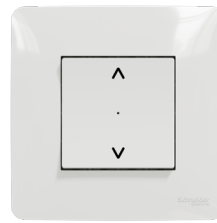

Connected shutter control

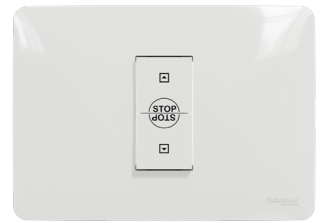

One-module shutter control

Temperature control

Unica thermostats can set a temperature and maintain it at a comfortable level as the outside temperature fluctuates, while also helping to reduce energy costs.



Thermostat



A worldwide range

To cater to different standards worldwide and diverse homeowner needs, Unica provides a broad selection of socket outlets.

All socket outlets have integrated child protection. The self-sealing shutters sit behind the electrode holes and close when the plug is removed, reducing the risk of a child inserting something into the holes.

Socket outlets for diverse needs and standards

Unica features standard socket outlets with lid and surface socket outlets that provide high aesthetics and prevent dust allocation inside the outlet. For extra safety, socket outlets with surge protection are available. The IP44 devices can be used outdoors (see the "Robust and weather resilient" section). The range features socket outlet versions available in almost all of the local standards.



Side earth outlet



Side earth socket with lid



Surface pin earth socket



Socket with surge protection

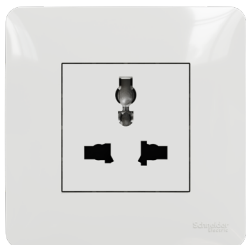

Multistandard socket

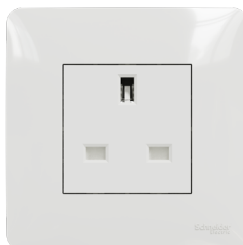

British socket

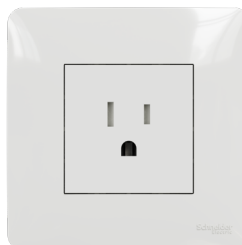

American socket

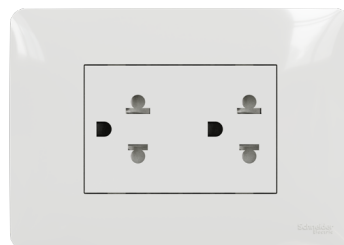

Euroamerican socket 3 modules



Connected socket outlets

These outlets enable energy use monitoring for reducing costs.



Connected socket

Socket outlets with USB

Sockets with an added USB-C port provide maximized flexibility and use of space.



Surface pin earth socket with USB



Side earth socket with USB

Technology that connects

With an array of devices facilitating connectivity, Unica helps ensure your customers can use digital technologies in every corner of their house, without having to worry about low battery levels or network reach.

USB chargers

USB chargers include a quick charging option up to 18 W (3 A), with type A and type C ports that can charge a battery up to 75 percent in as little as 30 minutes.



USB quick charger type A+C



USB charger type A



Side earth socket with USB type C



Surface pin earth socket with USB type C



1-module USB charger type A

Connectivity everywhere

The Wi-Fi repeater makes the internet available throughout the house. The range also includes R/TV sockets, RJ45 inserts, and central plates as well as HDMI sockets to neatly connect HDTV and AV components.



Wi-Fi repeater

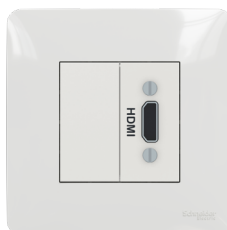

HDMI outlet



R-TV/SAT outlet



RJ45 data socket

EVERYDAY YOUR WAY

Robust and weather resilient

With Unica, you can provide convenient power access and connectivity even outdoors.

Outdoor devices

From IP44 switches and sockets to IP55 frames and compatibility with Mureva boxes, the range has devices that can be installed on balcony, a terrace, or a garden.



IP44 switch



IP44 socket outlet

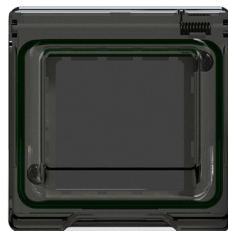

IP55 Mureva
Box with Unica
function



IP55 cover frame



Make homes smart and sustainable with Wiser and Unica

By choosing connected Unica devices and integrating them into the Wiser smart home system, you can offer your customers enhanced comfort, energy savings, and greater safety.

Wiser allows homeowners to conveniently control lighting, shutters, heating, and more, both locally and remotely, through the Wiser by SE app, voice assistants, or the Unica wireless switch.



Wiser is compatible with Amazon Alexa™, Google Assistant™, and Apple's Siri®.

Moments

Wiser helps personalize a home by creating scenarios that combine several settings. For example, switching off all the lights and closing all the shutters for a Sleep Moment. A pre-set moment can be activated with just one tap in the Wiser by SE app or a voice command.

Automations

Moments can activate automatically at a scheduled time or when predefined conditions are detected. For example, lights can be switched off in a room when no presence is detected for 10 minutes.

Notifications

Wiser keeps homeowners aware of what's going on at home, even when they're away; the system sends notifications when issues are detected, such as water leakages or open windows or doors.



Safety and security



Gateway IP Camera Sensors

Lights, shutters, and appliances

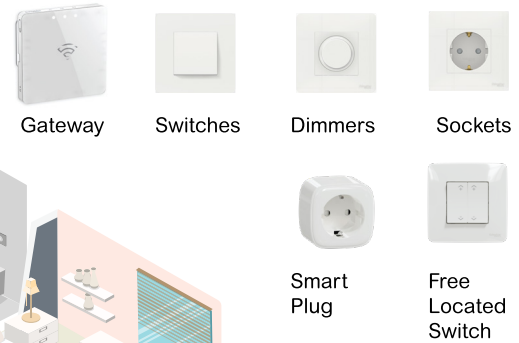

Gateway Switches Dimmers Sockets Smart Plug Free Located Switch



Voice control device



Wiser by SE app



Free Located Switch

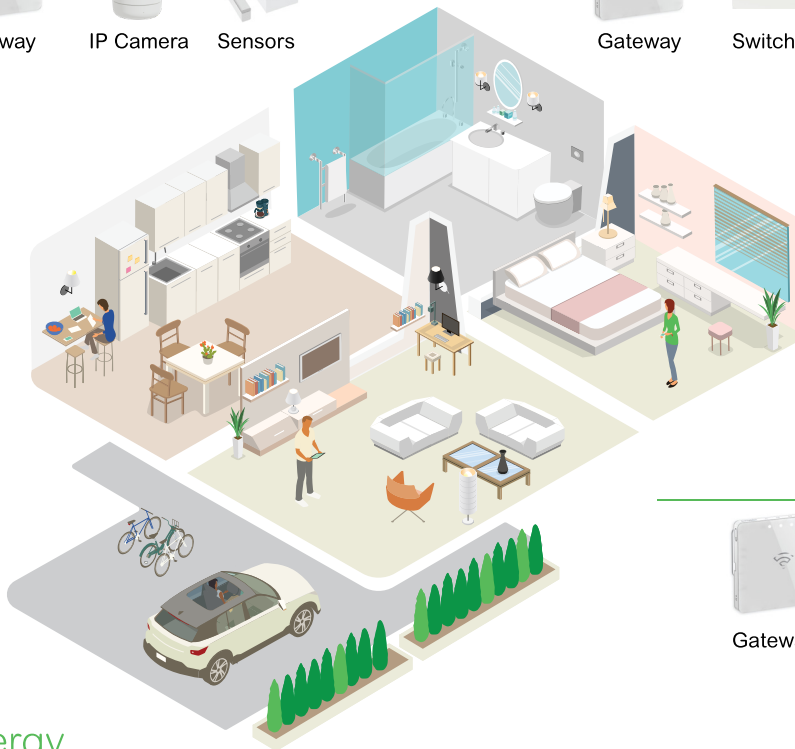

Temperature



Gateway Radiator Thermostat IR Converter

Energy



Gateway Sockets Smart Plug PowerTag

Introduce your customers the benefits of Wiser living

Wiser gives homeowners a convenient way of managing home settings and adjusting them to their preferences. The system also helps spot and cut energy waste and protect homes from potential intruders, faults, or simple forgetfulness.



Greater comfort

Welcome moment

“My home ‘Welcomes’ me as soon as I open the door. Lights on, shutters up, and my favorite music on.”

Voice control

“When my hands are full, a voice assistant turning on the lights for me is a blessing.”

Cinema moment

“One tap and the perfect mood is set: dimmed lights, closed shutters, and a cozy temperature.”



Enhanced safety

Presence simulation

“When I’m away, Wiser simulates my presence at home with lights on and shutters open at pre-set times.”

Remote control

“Did I switch off the iron this morning? No worries, I can just check the Wiser app.”

Peace of mind

“I feel safer knowing Wiser will notify me about a water leakage so I can turn all nearby sockets off.”

Energy savings

Appliance control

“After I leave home, I can easily turn off non-essential electrical appliances with one click not to waste energy.”

Automations

“Kids forget about everything! Fortunately, Wiser turns off the lights and A/C when it detects no presence in the room or a window is open.”

Protection from external conditions

“I use the ‘Summer’ moment to automatically close the shutters during the sunny hours to optimize energy use on cooling.”





Workspaces tailored to any need

The Unica range provides the full scope of functions needed in a modern office. Socket outlets, network connectivity, multimedia outlets, and more. What your client needs, Unica delivers.



Single, double, and triple socket outlets

A selection of different outlet configurations lets you flexibly adapt to customer demands. Choose from socket outlets with screw and screwless mounting and double socket outlets with an IPT connection. All are simple to install. Color options are available.



Surface-mounted socket outlets

For areas with no dust allowed, surface-mounted sockets are a perfect choice. With an enhanced design, the outlets have a sleeker look for improved workspace aesthetics.

All Unica functions are compatible with Unica System+ devices, including workstations, floor boxes, desk units, poles and posts, and cable management solutions. Function modules can also be directly clipped into OptiLine 45 trunking for a seamless and highly aesthetic look.

EVERYDAY YOUR WAY

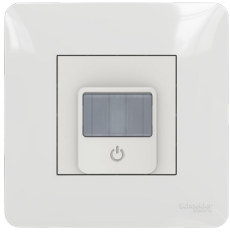

Motion sensor



Rotary dimmer

Light control functions

Rotary and pushbutton LED dimmers enable your customers to adjust the brightness of lights in areas like meeting rooms.

Motion sensors installed in areas like corridors or toilets help ensure the lights are on only when needed.

For more energy savings, a programmable timer can be used to switch off office devices, such as printers, during non-working hours.

Light control functions

From devices dedicated to USB charging to regular sockets with in-built USB slots, the Unica range provides powerful flexibility.

A quick charger with USB A and C can charge a battery up to 75 percent in as little as 30 minutes. Two different slots mean customers can charge diverse types of devices. The compact design and dual-charging options help maximize the use of space.

Another space-saving option is a one-module USB charger that can be used in workstations, for example.

A regular socket outlet with a USB-C port pulls double duty, powering electrical equipment and charging USB devices simultaneously.



HDMI outlet

Multimedia outlets

Unica provides a complete set of multimedia outlets to cover any functionality needed in a meeting room. The devices are quick and easy to install and can be seamlessly integrated into the environment.

EVERYDAY YOUR WAY

Network connectivity

The full Unica network connectivity offer works with any Schneider Electric S-One connector and is also compatible with Keystone and SYSTIMAX connectors. Available in different sizes and two versions, inclined and flat, the modules can fit any application. Narrow modules are available in 45x45 mm size and standard modules in 45x90 mm size perfect for vertical workstations or poles and posts.

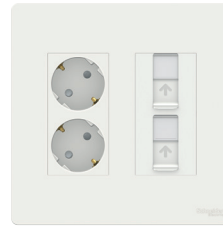

Flush mounting workstation



With a broad selection of modules, you can easily find a solution for a specific application.

Switches and socket outlets for outdoor and special areas

Unica devices are also available with IP44-rated protection. They have the same stylish appearance as regular switches and sockets but are more resistant to dust, water, etc.

IP55-rated frames are perfect for bathroom installations, while Unica devices combined with Mureva Boxes can be used for example in parking lots.





Maximized functionality, minimized space

When space is at a premium and you have multiple functions to fit, Unica System+ workstations come to the rescue.

Available in multiple sizes, in vertical or horizontal formats, for flush or surface mounting, these workstations help you deliver flexibility and convenience for office occupants.

Three color options – white (also available in antibacterial finish), aluminum, and anthracite – perfectly match Unica frames and help you create a uniform interior aesthetic. Unica System+ workstations are compatible with all function inserts offered by the Unica range.



Antibacterial

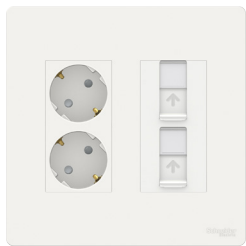

Flush mounting workstation
White



Flush mounting workstation
Aluminium

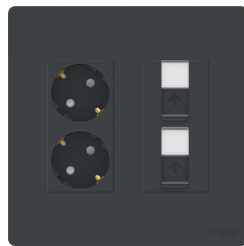

Flush mounting workstation
Anthracite

Unica System+ workstations are also available in a white antibacterial finish (find out more in the “Make the office a safer space” section).

	Vertical	Horizontal
Surface		
Flush		

EVERYDAY SIMPLE

Ingenious design

Unica fixing frames as well as modular switches and sockets are designed to make installation smoother than ever.

Easy installation

More compact inserts with extra space for wiring and easy-to-access release buttons are just two examples of the clever features that help you save time on mounting.

Easy clipping

The size of Unica inserts allows for direct clipping in the OptiLine 45 trunking. This major simplification means one insert type can now be used for both homes and commercial buildings.

“

One of the most important features we instilled in Unica is ingenuity so the electrician could install more devices faster through the simplicity of design. ”

Frédéric Beuvry,
Vice President Industrial Design & Ergonomics
at Schneider Electric



Install faster and smarter

Speed up your work with the ingenious features of Unica wiring devices.

Fixing frames

Flexible installation
Thanks to symmetric fixing frame sides.

Secure fixing
Finer tolerance between the fixing frame and the insert. Less dangling, as the insert sits securely in the fixing frame.

Robust design
The Unica fixing frame is bigger and more rigid due to the smaller 40 x 40 mm insert window. This provides extra strength to the frame to help prevent distortion during fastening the clips.

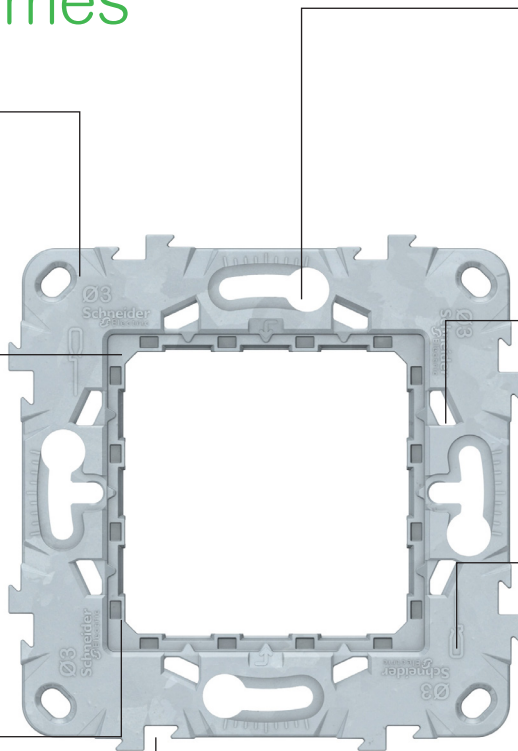

Perfect alignment
Unica's interlocking system helps avoid misalignment and slipping when installing two or more products in a multi-gang frame.

Easy adjustment
The screw slots allow rotation of the fixing frame in either direction, so the frame can be correctly mounted even if the installation box is misaligned. These slots are a perfect fit for flush-mounted box standard screws, so fixing is now even easier and more secure.

Stronger connection
Finer tolerances between the fixing frame and the cover create a stronger connection for more reliable installation.

Intuitive mounting
Slots for the screwdriver on the front and back of the fixing frame enable removing the insert without leaving a mark on the product. They also help avoid injuries from placing the screwdriver in the wrong position. Inserts can be easily removed from the front and back.

Safe handling
The claws are protected with a plastic cover to prevent harm during installation.

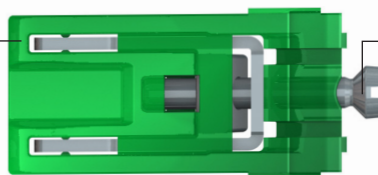

Reliable fixing
The claw length has been increased for better fixation in the box. When you hear a click sound, you know the claws are perfectly placed in the fixing frame.



Multiple versions

Fixing frames are available in plastic and zamak and with or without claws included. Available also for 1 to 7 module installations, and also for Double British Standard boxes.

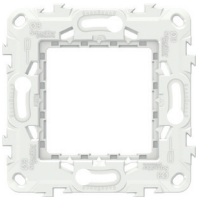

Plastic fixing frame
2 modules

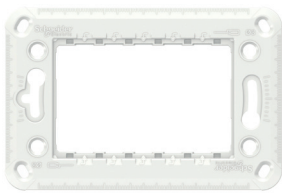

Plastic fixing frame
3 modules

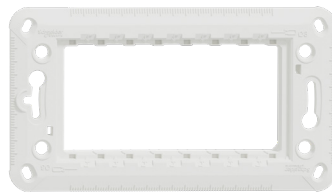

Plastic fixing frame
4 modules

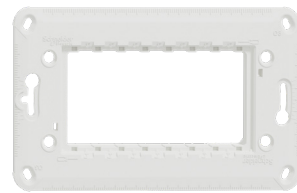

Plastic fixing frame
for Double British
Box

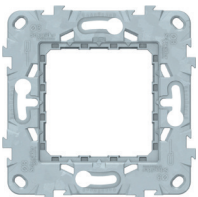

Zamak fixing frame
2 modules

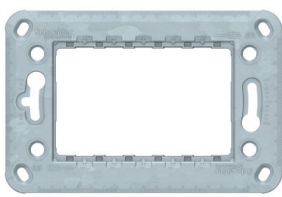

Zamak fixing frame
3 modules

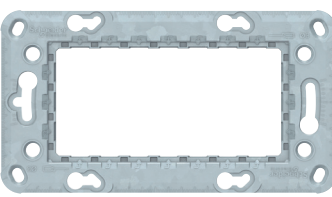

Zamak fixing frame
4 modules

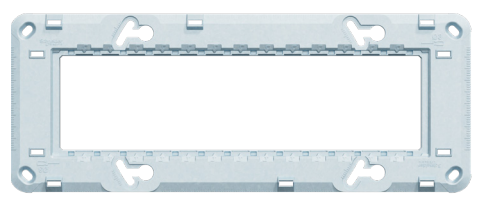

Zamak fixing frame
7 modules

Switch to smart design

Extra space

A low mounting depth of 21 mm provides more space for wiring.

Easy removal

Inserts can be removed from the front and back thanks to the clearly visible notches.

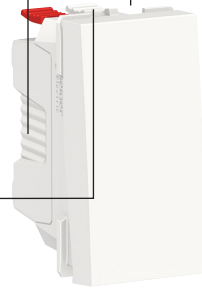

Secure clipping

The insert is more secure in the fixing frame due to the improved design of the clipping system.

Clear on/off status

The large rocker clearly indicates the status of the switch in the 'on' and 'off' positions. When switched off, the rocker angle is wider for increased separation of the contacts. This helps avoid electrical arc, makes the switch more secure, and improves its electrical performance.

Quick wiring

Prominent quick release buttons are easily accessible, so securing and releasing wires is quick and easy.

Simple connection

A wiring diagram is printed on the rear of the switch and pushbutton base to make connection options clearly visible.



Effortless wiring

Conical cable entries make it easier to feed the connection wires into the terminal blocks. Even thicker wires can be connected in less time thanks to the larger openings.



Easy indicator conversion

Add an indicator lamp to any switch, easily. Simply remove the standard rocker and add the accessory lamp and the rocker with a light window.

Convenient testing from the front

Checkpoints at the front allow convenient functions testing and measuring. Plus, there's no need to disassemble the switch – the rocker can be easily removed to access the checkpoints.



Special functions

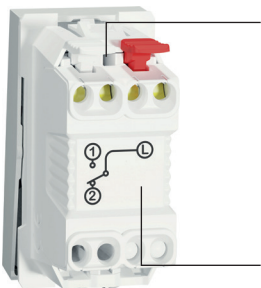

One-way switches and pushbuttons

For one-way switches and pushbuttons, the phase and neutral cable entries are on the top. This allows for simpler and faster wiring, without having to turn the insert to wire the other cable.

Slim insert

All white switch inserts come with a smaller housing which offers more space for fast and easy wiring.



Intermediate switch

Different colors indicating the two circuits make it easy to distinguish between them for simpler installation.

Upgradable pushbutton

All switch inserts with aluminum or anthracite rockers can be upgraded to a pushbutton thanks to a larger housing and a pushbutton spring.

EVERYDAY SIMPLE

Sockets with screw terminals

Extra space

A shallow mounting depth of 21 mm provides extra space for wiring.

Unclipped center plate

The center plate is unclipped, enabling easy removal of wiring.

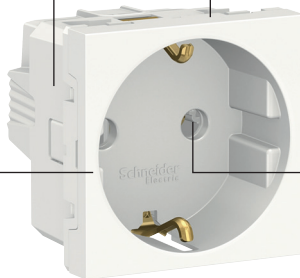

Easy removal

Inserts can be removed from the front and back thanks to the clearly visible notches. The center plate can also be removed easily.

Shock protection

Integrated shutters protect against accidental contact and the ingress of foreign objects.

Large cable entries

Entries allow for wiring rigid and flexible cables of 2.5 mm² and 4 mm².

Fast wiring

With the cable entries beside each other, you can cut all wires to the same length. The screws are unfixed, so you don't have to unscrew them before you start to wire the cables.

Improved protection

Cable entries are clearly separated to make wiring more intuitive and help avoid short-circuit risk when flexible wires are used.



Sockets with screwless terminals

Extra space

A low mounting depth of 21 mm provides extra space for wiring.



Easy removal

Inserts can be removed from the front and back thanks to the clearly visible notches. The center plate is also easy to remove.

Shock protection

Integrated shutters protect against accidental contact and the ingress of foreign objects.

Effortless wiring

Conical cable entries make it easier to feed the connection wires into the terminal blocks. Thanks to larger openings, even thicker wires can be easily connected.

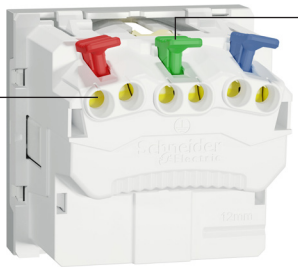

Quick wiring

Screwless socket outlet terminals and color-coded quick-release buttons make securing and releasing wires quick and easy, without removing the center plate.

Special socket outlets



Socket outlet with lid which can be opened to 180°



Double socket outlet

The new Unica range includes socket outlets for a variety of applications, including single, double, and multi-gang outlets. They offer screw and screwless options, with extra room and wider openings for quicker, simpler wiring.

Versatile workstations

With Unica System+ workstations, available as both flush- and surface-mounted, in vertical or horizontal orientation, in several sizes and finishes, you will easily deliver the right solutions for any workspace.

Flush-mounted box

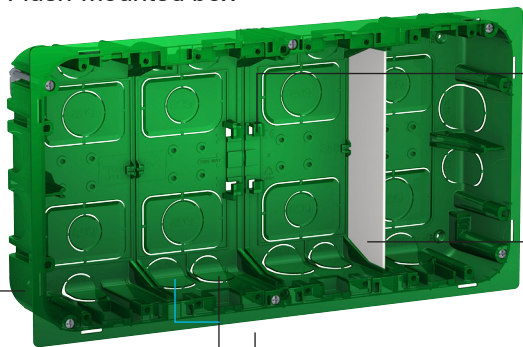

Holes for 25 mm Ø and 20 mm Ø tubes.

Easier data cable installation
Box depth of 50 mm for easier installation of Cat6 and 6 A data cables.

Broad flat frame
Enabling perfect installation, even when the walls are uneven. The broad frame also stands proud of slightly larger holes to avoid "falling".

Surface-mounted box

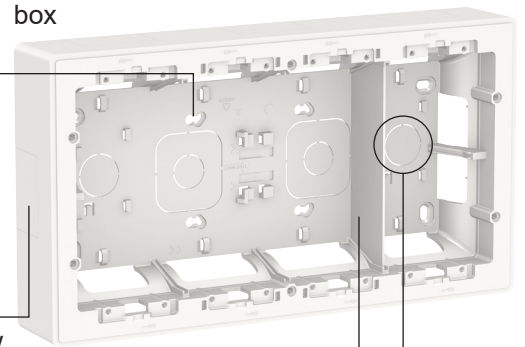

Easy adjustment
The mounting holes allow vertical and horizontal movement to balance the boxes for perfect alignment every time.

Flexible installation
Several entrances allow mounting without drilling.

Added security
Slide-in dividers keep power and data cables separated for extra safety.

Flush-mounted box compatibility
Workstations can be placed in a flush-mounted installation box instead of bringing the cables in via the mini-trunking. The box features entry holes for the cables.

Faster installs
The boxes come with pre-mounted and unscrewed screws to speed up installation.

Easy fixing
The fixing frames can be clipped directly to workstations, without tools.

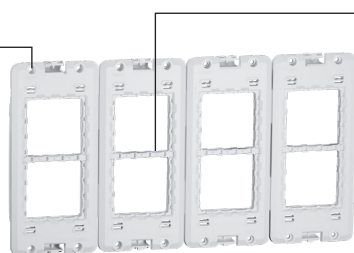

Fixing frame

Flexible clipping
Small bars allow single inserts to be clipped in and removed with greater flexibility. The bars allow any Unica insert to be fitted into the boxes.

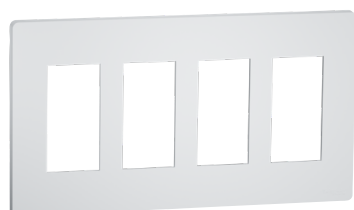

Design frame

No adaptors needed
The removable bar on the fixing frame allows secure fixing of single functions without an adaptor. You can also clip in one- or two-module inclined RJ45 connectors to the workstation.

Mini-trunking compatible
Unica System+ products are compatible with Schneider Electric mini-trunking.

DIN-rail ready
The use of an adaptor allows mounting of DIN-rail products such as Acti9.

Connect multiple boxes
A small adaptor allows connecting of several boxes.

Special functions for commercial applications

Unica System+ and OptiLine 45 trunking accept all Unica inserts. For faster installation, double- and triple-socket outlets and RJ45 inserts with two or four connectors are available. Even DIN rail products such as Acti9 can be fitted in with an adaptor.

Double socket outlet

Screw IPT terminal

Double socket outlets feature insulated piercing terminals. You don't have to insulate the wires with a tool – just insert them, close the levers, and insulation is done automatically. Disassembling is also easy, and the inserts can be reused.

Flexible cable sizes

Inserts accept 1.5 mm² and 2.5 mm² rigid and flexible cables.

Screws on the back

There's no need to remove the center plate to screw – the center plate is simply clipped in.

Easy installation

The big levers can be opened up to 90° for easy wiring and removing cables.

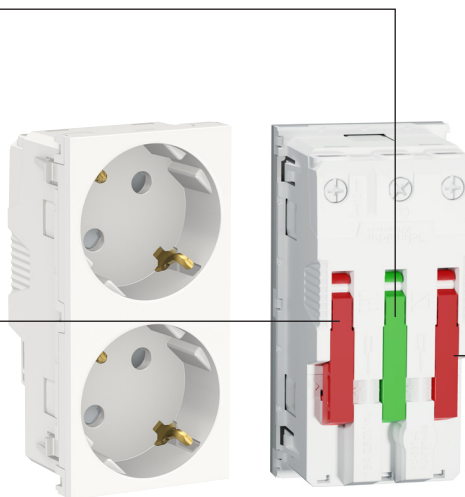

RJ45

Time-saving installation

Unica offers several designs of RJ45 center plates. The double and quadruple versions speed up installation as you only need one device and less space for up to four connectors.

Label holders

A convenient solution to help you identify the connected devices.

Protective shutters

They prevent the ingress of dust and other objects when the port is not in use.

Installation flexibility

The center plates can be used with any S-One Schneider Electric connector.



Clever solutions for flexible fixing

Multifix flush mounting boxes

The perfect way to fit Unica in plasterboard walls.

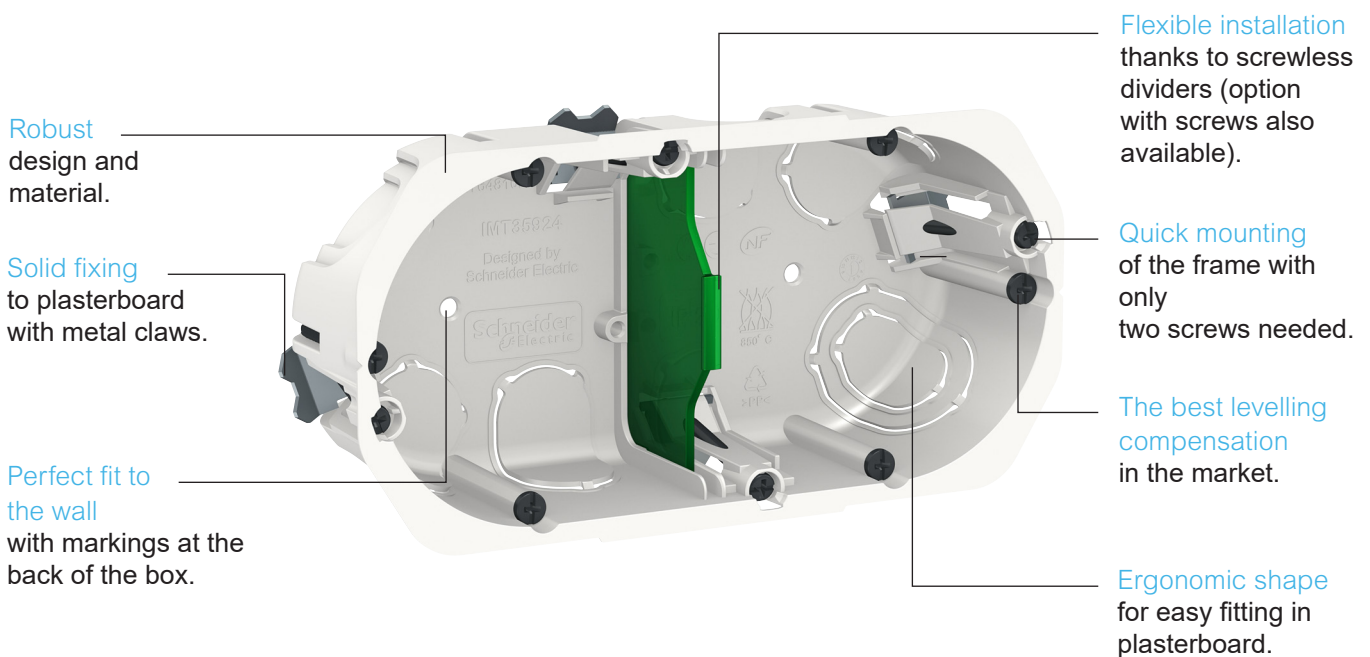

Multi-gang fixing frame

Adaptable to diverse needs.

The fixing frame can be used both for gang installations and, thanks to the movable dividers, for full window installations. In the latter case, the dividers are moved to the sides to cover wired parts for greater safety.



EVERYDAY SIMPLE



Standard gang installation



Full window installation

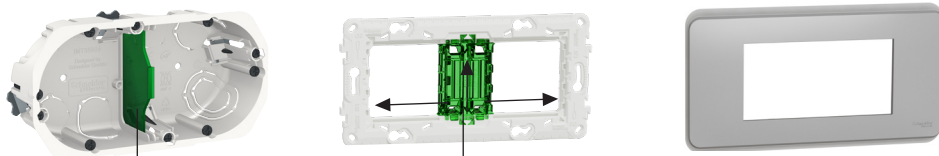

Remove the divider by hand to get a full window.

The dividers can be easily removed from the front or the back and clipped on the sides to keep inserts and wires completely covered for greater safety.



Backward compatibility

Because Unica has long been a popular choice for homes and buildings throughout Europe, it was a priority to make all of the new additions to the range backward compatible to easily integrate with legacy installations where necessary.

How the backward compatibility works

The new Unica inserts are more compact than the old Unica inserts*, so the fixing frame window in the new Unica is smaller. The back part of the new Unica insert is also smaller, but the old and new rockers have the same outer dimension (45x45 mm).

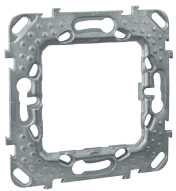

The old Unica fixing frame (44x44 mm)

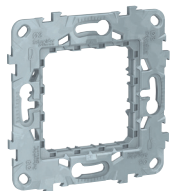

The new Unica fixing frame (40x40 mm)



The new Unica insert (40x40 mm) and the rocker (45x45 mm)

You can fit new Unica inserts in the old Unica fixing frames with the adaptor.

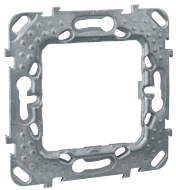

The old Unica fixing frame (44x44 mm)



The adaptor



The New Unica insert (40x40 mm). The rocker is still 45x45 mm.

The old and new Unica frames are 100% compatible with inserts, fixing frames, and rockers from both the old and the new range.

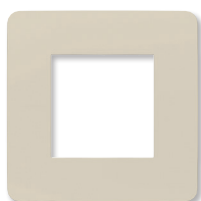
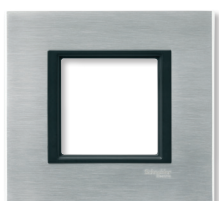

*The old insert cannot be placed in the new fixing frame.

Unica

Inserts

Content

Switches	50
Specialized controls	54
Comfort devices	56
Sockets	58
USB Chargers	62
Data / Phone / TV	63
Other functions	67
Dedicated trunking applications	69

10 AX - 250 V AC switches

	One-way	One-way with indication lamp and symbol	Two-way	Two-way with indication lamp and symbol	Two-way with neutral terminal	Intermediate	Double one-way	Double two-way	IP44
2 modules									
<input type="checkbox"/> white	NU320118	-	NU320318 ⁽¹⁾ NU320318F ⁽²⁾ NU320318P ⁽³⁾	-	NU320318S	NU320518	NU321118	NU321318 NU321318F	NU528218
<input type="checkbox"/> aluminium	NU320130	-	NU320330	-	NU320330S	NU320530	NU321130	NU321330	NU528230
<input type="checkbox"/> beige	NU320144	-	NU320344	-	-	NU320544	NU321144	NU321344	NU528244
<input type="checkbox"/> anthracite	NU320154	-	NU320354	-	NU320354S	NU320554	NU321154	NU321354	NU528254
1 module									
<input type="checkbox"/> white	NU310118	NU310118SMUR	NU310318 NU310318F	NU310318SDND	NU310318S	NU310518	-	-	-
<input type="checkbox"/> aluminium	NU310130	-	NU310330	-	NU310330S	NU310530	-	-	-
<input type="checkbox"/> beige	NU310144	-	NU310344	-	-	NU310544	-	-	-
<input type="checkbox"/> anthracite	NU310154	-	NU310354	-	NU310354S	NU310554	-	-	-

Characteristics

- Connection: screwless terminals
- Cables: 1 to 2.5 mm² rigid/flexible

Lighttable with NU9825A, NU9823AM and NU9825AZ LED lamps and rockers with visor











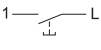
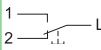
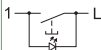

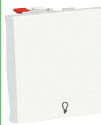

- (1) flow-pack
(2) no individual, flow-pack
(3) pack of 100 in a box

	One-way	Two-way	Intermediate
2 modules			
		-	-
<input type="checkbox"/> white	NU320118SC	-	-
<input type="checkbox"/> aluminium	-	-	-
<input type="checkbox"/> beige	NU320144SC	-	-
<input type="checkbox"/> anthracite	-	-	-
1 module			
<input type="checkbox"/> white	NU310118SC	NU310318SC	NU310518SC
<input type="checkbox"/> beige	NU310144SC	NU310344SC	-

Characteristics

- Connection: screw terminals
- Cables: 1 to 2.5 mm² rigid/flexible
- Lighttable with NU9825A, NU9823AM and NU9825AZ LED lamps and rockers with visor

10 A - 250 V AC push-buttons



	NO			NO/NC		NO with location lamp		
	without symbol	with bell symbol	with light symbol	without symbol	with label holder	without symbol	with bell symbol	with light symbol
								
2 modules								
								
<input type="checkbox"/> white	NU320618 ⁽¹⁾ NU320618F ⁽²⁾	NU320618C	NU320618L	NU323618	NU324620	NU320618N ⁽¹⁾ NU320618FN ⁽²⁾	NU320618CN	NU320618LN
<input type="checkbox"/> aluminium	NU320630	NU320630C	NU320630L	NU323630	NU324630	NU320630N	NU320630CN	NU320630LN
<input type="checkbox"/> beige	NU320644	-	-	-	-	NU320644N	NU320644CN	-
<input type="checkbox"/> anthracite	NU320654	NU320654C	NU320654L	NU323654	NU324654	NU320654N	NU320654CN	NU320654LN
1 module								
								
<input type="checkbox"/> white	NU310618 ⁽¹⁾ NU310618F ⁽²⁾	NU310618C	NU310618L	NU313618	-	NU310618N	NU310618CN	-
<input type="checkbox"/> aluminium	NU310630	NU310630C	NU310630L	NU313630	-	NU310630N	-	-
<input type="checkbox"/> beige	NU310644	-	-	-	-	NU310644N	NU310644CN	-
<input type="checkbox"/> anthracite	NU310654	NU310654C	NU310654L	NU313654	-	NU310654N	-	-

Characteristics

- Connection: screwless terminals
- Cables: 1 to 2.5 mm² rigid/flexible
- Lightable with NU9825A, NU9823AM and NU9825AZ LED lamps and rockers with visor

(1) flow-pack

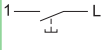
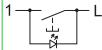
(2) no individual, flow-pack

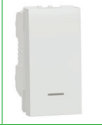
	NO	NO with location lamp
	without symbol	without symbol
		
1 module		
		
<input type="checkbox"/> white	NU310618SC	NU310618NSC
<input type="checkbox"/> aluminium	-	-
<input type="checkbox"/> beige	-	NU310644NSC
<input type="checkbox"/> anthracite	-	-
Characteristics		
<ul style="list-style-type: none"> • Connection: screw terminals • Cables: 1 to 2.5 mm² rigid/flexible • Lightable with NU9825A, NU9823AM and NU9825AZ LED lamps and rockers with visor 		



16 AX - 250 V AC switches

	One-way	One-way with indication lamp	Two-way	2 poles	2 poles with indication lamp	3 poles
2 modules						
□ white	NU326118	NU326118N	NU326318	NU326218	NU326218S	NU328118
■ aluminium	-	-	NU326330	NU326230	NU326230S	-
■ beige	NU326144	-	-	-	-	-
■ anthracite	-	-	NU326354	NU326254	NU326254S	-
1 module						
□ white	NU316118	NU316118S	NU316318	NU316218	NU316218S	-
■ aluminium	NU316130	-	NU316330	-	-	-
■ beige	NU316144	NU316144S	NU316344	-	NU316244S	-
■ anthracite	NU316154	-	NU316354	-	-	-
Characteristics						
<ul style="list-style-type: none"> • Connection: screw terminals • Cables: 1 to 2.5 mm² rigid/flexible • Lighttable with NU9825A, NU9823AM and NU9825AZ LED lamps and rockers with visor 		<ul style="list-style-type: none"> • Connection: screw terminals • Cables: 1 to 4 mm² rigid/f 		<ul style="list-style-type: none"> • Connection: screw terminals • Cables: 1 to 2.5 mm² rigid/flexible • Lighttable with NU9825A, NU9823AM and NU9825AZ LED lamps and rockers with visor 		

High rating switches

	20 A 2 poles	30 A 2 poles with indication lamp
2 modules		
□ white	NU322518	NU323218S
■ aluminium	-	NU323230S
■ beige	-	NU323244S
■ anthracite	-	NU323254S
Characteristics		
<ul style="list-style-type: none"> • Connection: screw terminals • Cables: up to 4 mm² rigid/flexible 		<ul style="list-style-type: none"> • Connection: screw terminals • Cables: up to 6 mm² rigid/flexible

Accessories - Lamps

LED lamps	12-24 V DC	250 V AC	
	White	Red	White
			
	NU9823AM	NU9825A	NU9825AZ

Characteristics

Consumption	0.15 mA	1,5 mA	0,05 mA
-------------	---------	--------	---------

Spring to transform a switch to push-button

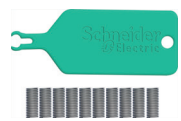





S520299

Characteristics

- 10 units delivered with a positioning aid tool

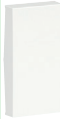
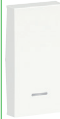
Accessories - Rockers

Rockers	without symbol	with visor	for Unica MGU●●●●●●
2 modules			
			
<input type="checkbox"/> white	NU920018	NU920018N	NU920018U
<input type="checkbox"/> aluminium	NU920030	NU920030N	NU920030U
<input type="checkbox"/> beige	NU920044	NU920044N	NU920044U
<input type="checkbox"/> anthracite	NU920054	NU920054N	NU920054U
1 module			
			
<input type="checkbox"/> white	NU910018	NU910018N	NU910018U
<input type="checkbox"/> aluminium	NU910030	NU910030N	NU910030U
<input type="checkbox"/> beige	NU910044	NU910044N	NU910044U
<input type="checkbox"/> anthracite	NU910054	NU910054N	NU910054U

Inserts

Specialized controls

Fan controls

	Two-way 10 A	Two-way - On/Off - 10 A
2 modules		
<input type="checkbox"/> white	NU320320VMC	NU321418
<input type="checkbox"/> aluminium	NU320330VMC	NU321430
<input type="checkbox"/> anthracite	NU320354VMC	NU321454

Shutter controls

	Push-button 10 A	Switch	2 poles Push-button	Switch
1 modules				
<input type="checkbox"/> white	NU310718SC	NU310818SC	NU312718SC	NU310918SC
<input type="checkbox"/> aluminium	NU310730SC	NU310830SC	-	-
<input type="checkbox"/> beige	NU310744SC	NU310844SC	NU312744SC	NU310944SC
<input type="checkbox"/> anthracite	NU310754SC	NU310854SC	-	-
Characteristics				
<ul style="list-style-type: none"> • Connection: screw terminals • Cables: 1 to 2.5 mm² rigid/flexible 				

	Push-button 6 A	10 A	Switch 6 A
2 modules			
<input type="checkbox"/> white	NU320718	NU323718	NU320818
<input type="checkbox"/> aluminium	NU320730	NU323730	NU320830
<input type="checkbox"/> beige	NU320744	-	NU320844
<input type="checkbox"/> anthracite	NU320754	NU323754	NU320854
Characteristics			
<ul style="list-style-type: none"> • Connection: screwless terminals • Cables: 1 to 2.5 mm² rigid/flexible 			

Cord push-buttons

	NO/NC - 10 A
2 modules	
<input type="checkbox"/> white	NU322620
<input type="checkbox"/> aluminium	NU322630
<input type="checkbox"/> beige	NU322644
<input type="checkbox"/> anthracite	NU322654
Characteristics	
<ul style="list-style-type: none"> • Connection: screwless terminals • Cables: 1 to 2.5 mm² rigid/flexible 	

Key switches

	Push-button - 16 A	Switch - 16 A
2 modules		
<input type="checkbox"/> white	NU373118	NU370118
<input type="checkbox"/> aluminium	NU373130	-
<input type="checkbox"/> anthracite	NU373154	-
Characteristics		
<ul style="list-style-type: none"> • 3 positions 		

Card push-buttons

NO/NC - 10 A	
2 modules	
	
<input type="checkbox"/> white	NU328318
<input type="checkbox"/> aluminium	NU328330
<input type="checkbox"/> beige	NU328344
<input type="checkbox"/> anthracite	NU328354





Emergency stop

Key switch - 10 A		Mushroom - 10 A	
2 modules			
			
<input type="checkbox"/> yellow	ALB45032	<input type="checkbox"/> yellow	ALB45033



Inserts

Comfort devices

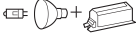
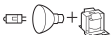
Dimmers

	Universal	Compensation module LED
2 modules		
		
<input type="checkbox"/> white	NU351418	
<input type="checkbox"/> aluminium	NU351430	
<input type="checkbox"/> anthracite	NU351454	
Load compensation module		
		CCT90501
Maximum loads		
LED lamp 230 V		RC: 5...100 VA RL: 5...20 VA
incandescent lamp 230 V		5...200 W
halogen lamp 230 V		5...150 W
LV halogen lamps 12 V	electronic transformer 	5...150 VA
	wound transformer 	5...150 VA
Characteristics		
<ul style="list-style-type: none"> Remote control by unlimited number of auxiliary push-button Automatic load detection Wire configuration without neutral Screw terminals connection Memory function Automatic overload protection, overheating protection, short-circuit protection 		<ul style="list-style-type: none"> Rated voltage: 230 VAC Frequency range: 50 - 60 Hz Power loss: 2 W max. Installation: junction box, in the luminaire or in the sub-distribution panel, wired between neutral and dimmed phase.

Thermostats





	Room - 8 A	Floor - 10 A
2 modules		
		
<input type="checkbox"/> white	NU350118	NU350318
<input type="checkbox"/> aluminium	NU350130	NU350330
<input type="checkbox"/> beige	NU350144	NU350344
<input type="checkbox"/> anthracite	NU350154	NU350354
Characteristics		
	<ul style="list-style-type: none"> For heating or air-conditioning Settings range: + 5 to + 30 °C Blue and red LED's for conditioning or heating indication 	<ul style="list-style-type: none"> For floor heating Settings range: + 5 to + 45 °C Green LED for voltage supply indication Red LED for heating indication Delivered with a 4 m temperature sensor

Unica

Inserts

Comfort devices

Motion sensors

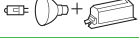
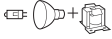
		10 A
2 modules		
		
<input type="checkbox"/> white		NU352518
<input type="checkbox"/> aluminium		NU352530
<input type="checkbox"/> anthracite		NU352554
Maximum loads		
LED lamp 230 V		200 W
incandescent lamp 230 V		2200 W
halogen lamp 230 V		2000 W
motor (single-phase) 230 V		1000 VA
LV halogen lamps 12 V	electronic transformer 	1050 VA
	wound transformer 	500 VA
Characteristics		
<ul style="list-style-type: none"> • Screw terminals connection • Wire configuration with neutral • Detection angle: 160 ° • Movement detection area: 8 m frontal, 8 m lateral • Remote control by unlimited number of auxiliary push-button • Automatic load detection • Built-in on/off push-button switch • Time delay range: 1...30 min • Master/slave option; two sensors can be connected together to cover larger area 		







Timers



		Countdown timer relay - 10 A
2 modules		
		
<input type="checkbox"/> white		NU353518
<input type="checkbox"/> aluminium		NU353530
<input type="checkbox"/> anthracite		NU353554
Characteristics		
<ul style="list-style-type: none"> • Time delay range: 5 min to 8 h • Integrated status LED • 3-wires (neutral required) 		

Electronic card switch

		8 A
		
<input type="checkbox"/> white		NU354018
<input type="checkbox"/> aluminium		NU354030
<input type="checkbox"/> anthracite		NU354054
Characteristics		
<ul style="list-style-type: none"> • 8 A • Timed 10 seconds 		

Side Earth sockets

90°	With shutters screwless	With shutters screw	Without shutters screw	With lid & shutters screw	IP44 frame with shutters	IP44 with shutters	Single socket+USB		
2 modules									
									
□ white	NU305718	NU303718	NU303618	NU303718TA	NU003718	NU508218	NU301718		
■ aluminium	NU305730	NU303730	-	NU303730TA	-	NU508230	NU301730		
■ beige	NU305744	NU303744	NU303644	NU303744TA	NU003744	NU508244	NU301744		
■ anthracite	NU305754	NU303754	-	NU303754TA	-	NU508254	NU301754		
■ orange	-	NU303761	-	-	-	-	-		
■ red	NU305703	NU303703	-	-	-	-	-		
■ green	-	NU303706	-	-	-	-	-		
Characteristics									
<ul style="list-style-type: none"> ● 2P+E - 16 A - 250 V 						<ul style="list-style-type: none"> ● Screwless terminals ● 2P+E - 16 A - 250 V ● Shuttered 		<ul style="list-style-type: none"> ● 2P+E - 16 A - 250 V ● Screwless terminals ● Output power USB: 5 V 	

45°	Standard		With lamp
	Screwless	Screw *	Screw *
4 modules			
			
□ white	NU306618	NU306718A NU306718 ⁽¹⁾	NU306718AS NU306718S
■ aluminium	NU306630	NU306730A	NU306730AS
■ anthracite	NU306654	NU306754A	NU306754AS
■ red	NU306603	NU306703A NU306703 ⁽¹⁾	NU306703AS NU306703S ⁽¹⁾
■ green	-	-	NU306706AS
■ orange	-	-	NU306761AS
Characteristics			
<ul style="list-style-type: none"> ● 2P+E - 16 A - 250 V ● * for Screw devices - Screw-IPT terminals (except ⁽¹⁾): screw terminals in one side) ● With shutters 			

45°	Standard
6 modules	
	
□ white	NU307618
■ aluminium	NU307630
■ anthracite	-
■ red	NU307603
Characteristics	
<ul style="list-style-type: none"> ● 2P+E - 16 A - 250 V ● With shutters 	

Double Socket	
	
□ white	NU206718
■ aluminium	NU206730
■ beige	NU206744
■ anthracite	NU206754
Characteristics	
<ul style="list-style-type: none"> ● Screw terminals ● 2P+E - 16 A - 250 V 	

Pin Earth sockets

90°	Standard screwless	Standard screw	Surface screwless	Tamperproof screw	Sockets with surge protection	Single socket+USB
2 modules						
□ white	NU305918 NU305918E ⁽¹⁾ NU305918P ⁽²⁾	NU303918 NU303918E ⁽¹⁾	NU305218 NU305218E ⁽¹⁾ NU305218P ⁽²⁾	NU305118	NU305918EP	NU301518 NU301518E ⁽¹⁾
■ aluminium	NU305930 NU305930E ⁽¹⁾	NU303930 NU303930E ⁽¹⁾	NU305230 NU305230E ⁽¹⁾	-	NU305930EP	NU301530 NU301530E ⁽¹⁾
■ beige	NU305944E ⁽¹⁾	NU303944E ⁽¹⁾	NU305244E ⁽¹⁾	-	-	-
■ anthracite	NU305954 NU305954E ⁽¹⁾	NU303954 NU303954E ⁽¹⁾	NU305254 NU305254E ⁽¹⁾	-	NU305954EP	NU301554 NU301554E ⁽¹⁾
■ red	NU305903	NU303903E ⁽¹⁾	NU305203	NU305103	-	-
■ green	NU305906	-	NU305206	-	-	-
■ orange	NU305961	-	-	-	-	-
Characteristics						
<ul style="list-style-type: none"> • 2P+E - 16 A - 250 V • With shutters 					<ul style="list-style-type: none"> • 2P+E - 16 A - 250 V • Screwless terminals • Output power USB: 5 V 	



(1) For Czech Republic, Slovakia and Spain

(2) Pack of 100



45°	Standard			With lamp	Tamperproof		Tamperproof with lamp
	2 modules	4 modules	6 modules	4 modules	4 modules	6 modules	4 modules
□ white	NU304918	NU306918	NU307918	NU306918S NU306918SE ⁽¹⁾	-	-	-
■ aluminium	NU304930	NU306930	NU307930	NU306930S	-	-	-
■ anthracite	NU304954	NU306954	NU307954	NU306954S	-	-	-
■ red	NU304903	NU306903	NU307903	NU306903S NU306903SE	NU306103	NU307103	NU306103S
■ green	NU304906	NU306906	NU307906	-	-	-	-
Characteristics							
<ul style="list-style-type: none"> • 2P+E - 16 A - 250 V • Screwless terminals • With shutters 							

(1) For Czech Republic, Slovakia and Spain





Pin Earth double sockets

	Double with cover frame	Double socket
		
□ white	NU406918	NU206518
■ aluminium	NU406930	NU206530
■ beige	-	NU206544
■ anthracite	NU406954	NU206554
Characteristics		
	<ul style="list-style-type: none"> • 2P - 16 A - 250 V • Screw terminals • With shutters • Installation in 1 gang box 	<ul style="list-style-type: none"> • 2P - 16 A - 250 V • Screw terminals • Installation in 1 gang box



European sockets

	Simple	16 A	10 A	Double
		2 modules	1 modules	
				
□ white		NU303318	NU303118	NU206318
■ aluminium		NU303330	NU303130	-
■ beige		NU303344	NU303144	NU206344
■ anthracite		NU303354	NU303154	-
Characteristics				
		<ul style="list-style-type: none"> • 2P - 250 V • Screw terminals 		<ul style="list-style-type: none"> • 2P - 16 A - 250 V • Screw terminals • Installation in 1 gang box
*A residual current circuit protection with a sensitivity of 30 mA must be installed for this product.				

Euroamerican sockets

	1 module	Shutterd	2 modules	Shutterd
		1 module		3 modules
				
□ white	NU302018	NU302118	NU304118	NU306818
■ aluminium	-	NU302130	NU304130	-
■ beige	NU302044	NU302144	-	-
■ anthracite	-	NU302154	NU304154	-
Characteristics				
	<ul style="list-style-type: none"> • 16 A - 250 V AC for cylindrical pins • 15 A - 125 V AC for flat pins • Screw terminals 			
*A residual current circuit protection with a sensitivity of 30 mA must be installed for this product.				

American sockets

15 A	Single	Double
	2 modules	3 module
		
□ white	NU302818	NU306018
■ aluminium	NU302830	NU306030
■ anthracite	NU302854	NU306054
Characteristics		
	<ul style="list-style-type: none"> • 2P+E - 15 A • Screw terminals • Shuttered 	





Italian sockets

16 A	
1 module	
	
□ white	NU302318
■ aluminium	NU302330
■ beige	NU302344
■ anthracite	NU302354
Characteristics	
	<ul style="list-style-type: none"> • 2P+E - 16 A • Screw terminals • Shuttered



British sockets

13A	
2 modules	
	
□ white	NU304518
■ aluminium	NU304530
■ beige	NU304544
■ anthracite	NU304554
Characteristics	
	<ul style="list-style-type: none"> • 2P+E - 13 A • Screw terminals • Shuttered

Danish sockets

90°	Single	Double	Single EDB	Double EDB
	2 modules	4 modules	2 modules	4 modules
				
□ white	NU308818	NU309818	NU308918	NU309918
■ aluminium	NU308830	NU309830	NU308930	NU309930
Characteristics				
<ul style="list-style-type: none"> • 2P+E - 16 A - 250 V • EDB (Elektronisk Data Behanding) for electronic data processing 				

Multistandard sockets

	2 modules	3 modules
		
□ white	NU308418	NU308518
■ aluminium	NU308430	-
■ anthracite	NU308454	-
Characteristics		
<ul style="list-style-type: none"> • Screw terminals • Shuttered 		
*A residual current circuit protection with a sensitivity of 30 mA must be installed for this product.		



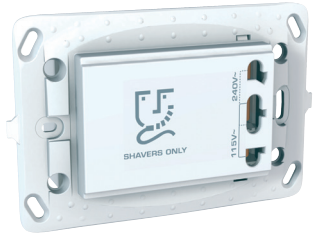

Israel sockets

	2 modules
	
□ white	NU304718
■ aluminium	NU304730
■ beige	NU304744
■ anthracite	NU304754
■ red	NU304703
Characteristics	
<ul style="list-style-type: none"> • 2P+E - 16 A • Screw terminals • Shuttered 	



Shaver sockets

20 VA	
	
□ white	MGU5.064.18
■ aluminium	MGU5.064.30
Characteristics	
<ul style="list-style-type: none"> • 3 modules • Input: 240 V • Output: 115/240 V 	

Accessories

Jumper for Side and Pin Earth sockets-outlets	Jumper for Danish sockets-outlets	Tamperproof accessory	Red LED lamp
			
NU9091	NU9092	ALB45290	NU9830
Characteristics			
<ul style="list-style-type: none"> • Set of 10 jumpers for multiple Side and Pin Earth screwless sockets-outlets 	<ul style="list-style-type: none"> • Set of 10 jumpers for multiple Danish screwless sockets-outlets 		<ul style="list-style-type: none"> • Plug & play

Centres plates for Side Earth Sockets

2 modules	
	
□ white	NU903718
■ aluminium	NU903730
■ beige	NU903744
■ anthracite	NU903754
For Unica MGU●●●●●●	
2 modules	
□ white	NU903718U
■ aluminium	NU903730U
■ beige	NU903744U
■ anthracite	NU903754U

Inserts

USB Chargers

USB chargers

	Chargers type A	Chargers type A+C				Charger type C		
2 modules								
white	NU341818	NU301818	NU301918	NU501318	NU501418	NU301518 NU301518E	NU301718	
aluminium	NU341830	NU301830	NU301930	NU501330	NU501430	NU301530 NU301530E	NU301730	
beige	NU341844	-	NU301944	NU501344	NU501444	-	NU301744	
anthracite	NU341854	NU301854	NU301954	NU501354	NU501454	NU301554 NU301554E	NU301754	
1 module								
white	NU342818	NU301618	-	-	-	-	-	
aluminium	NU342830	NU301630	-	-	-	-	-	
beige	NU342844	NU301644	-	-	-	-	-	
anthracite	NU342854	NU301654	-	-	-	-	-	
Characteristics								
	<ul style="list-style-type: none"> • NU3418●● Output power: 5 V DC - max 2.1 A • NU3428●● Output power: 5 V DC - 1 A 	<ul style="list-style-type: none"> • NU3018●● output power: 5 V DC - max 2.4 A • NU3016●● • Output power: 12 W 5V DC - 2.4 Max each port 	<ul style="list-style-type: none"> • Output power: 18W 5V DC - 2.4 Max each port 	<ul style="list-style-type: none"> • Output power: Type C 45W + Type A 7.5W 	<ul style="list-style-type: none"> • Output power: 65W 	<ul style="list-style-type: none"> • 2P+E - 16 A - 250 V • Screw terminals • Output power USB: 5 V • Output power: 10.5 W 		

Inserts

Data / Phone / TV

RJ45 data sockets

	Cat. 5e UTP straight	Cat. 5e STP straight	Cat. 6 UTP straight	Cat. 6 STP straight	inclined	Cat. 6 FTP straight	Cat. 6A UTP straight	Cat. 6A FTP straight
2 modules								
□ white	NU341118	NU341318	NU341518	NU341718	NU340718	NU341918 NU341918P ⁽¹⁾	-	NU344918
■ aluminium	NU341130	NU341330	NU341530	NU341730	NU340730	NU341930	-	NU344930
■ beige	NU341144	NU341344	NU341544	-	-	-	-	NU344944
■ anthracite	NU341154	-	NU341554	NU341754	NU340754	NU341954	-	NU344954
□ white	NU342018	-	-	NU342618	-	-	-	-
■ aluminium	NU342030	-	-	NU342630	-	-	-	-
■ anthracite	NU342054	-	-	NU342654	-	-	-	-
1 module								
□ white	NU341018	NU341218	NU341418	NU341618	NU340618	NU344718	-	NU344818
■ aluminium	NU341030	NU341230	NU341430	NU341630	NU340630	NU344730	-	NU344830
■ beige	NU341044	NU341244	NU341444	NU341644	-	-	-	NU344844
■ anthracite	NU341054	-	NU341454	NU341654	NU340654	NU344754	-	NU344854
4 modules								
□ white	NU347818	-	NU348218	-	-	-	NU348418	-
□ white	NU347918	-	NU348318	-	-	-	NU348518	

Characteristics

- Connector Actassi S-One
- Straight : with shutter and label space
- Inclined : with label space

(1) pack of 100

Inserts

Data / Phone / TV

RJ45 centre plates

	For S-One RJ45 connector		For Keystone/Systimax RJ45 connector	
	straight	inclined	straight	inclined
2 modules				
□ white	NU941118	NU940718	NU946118	NU946418
■ aluminium	NU941130	NU940730	NU946130	NU946430
■ beige	NU941144	-	NU946144	-
■ anthracite	NU941154	NU940754	NU946154	NU946454
□ white	NU942218*	NU942418*	-	-
■ aluminium	NU942230*	NU942430*	-	-
■ anthracite	NU942254*	NU942454*	-	-
□ white	NU942018	-	-	-
■ aluminium	NU942030	-	-	-
■ anthracite	NU942054	-	-	-
1 module				
□ white	NU941018	NU940618	NU946018	-
■ aluminium	NU941030	NU940630	NU946030	-
■ beige	NU941044	-	NU946044	-
■ anthracite	NU941054	NU940654	NU946054	-
4 modules				
□ white	NU947818	-	NU946218	-
■ aluminium	NU947830	-	NU946230	-
■ anthracite	NU947854	-	NU946254	-
□ white	NU947918	-	NU946318	-
■ aluminium	NU947930	-	NU946330	-
■ anthracite	NU947954	-	NU946354	-

Characteristics

- Straight: with shutter and label space
- Inclined: with label space
- Type: SLIM, except * DPM
- * Type: DPM

Optical fibre centre plates

	SC/SC APC Simplex	SC/SC APC duplex
	2 modules	
□ white	NU943918	NU943818
■ aluminium	NU943930	NU943830
■ anthracite	NU943954	NU943854





Characteristics

- Support to receive any SC simplex and duplex adapters
- Support to receive Actassy optical fibre adapters:
 - SC Duplex multi mode adapters: ref. n° VDIB6031001 and VDIB6031002
 - SC Duplex single mode adapters: ref. n° VDIB6032001 and VDIB6032002
 - SC APC Duplex single mode adapter: ref. n° VDIB6082001
 - SC APC Simplex single mode adapter: ref. n° VDIB6072001.





Inserts

Data / Phone / TV

Telephone sockets

	RJ12 connector	French standard phone jack	British telephone socket
2 modules			
			
<input type="checkbox"/> white	NU349718	NU349618	-
<input type="checkbox"/> aluminium	NU349730	NU349630	-
<input type="checkbox"/> beige	NU349744	-	-
<input type="checkbox"/> anthracite	NU349754	NU349654	-
1 module			
			
<input type="checkbox"/> white	NU349118	-	NU349918
<input type="checkbox"/> aluminium	NU349130	-	NU349930
<input type="checkbox"/> beige	NU349144	-	NU349944
<input type="checkbox"/> anthracite	NU349154	-	NU349954







Multimedia sockets

	VGA	Mini Jack	HDMI	RCA	Data Sockets
1 module					
					
<input type="checkbox"/> white	NU343218	NU343318	NU343018	NU343118	NU342918
<input type="checkbox"/> aluminium	NU343230	NU343330	NU343030	NU343130	NU342930
<input type="checkbox"/> beige	-	-	NU343044	-	-
<input type="checkbox"/> anthracite	NU343254	NU343354	NU343054	NU343154	NU342954
Characteristics					<ul style="list-style-type: none"> • USB 2.0

Inserts



Data / Phone / TV

TV sockets

	TV		TV/FM			R-TV/SAT			FM/TV/SAT
	male, individual	female, individual	individual	intermediate	terminal	individual	intermediate	terminal	individual (1 cable)
2 modules									
									
<input type="checkbox"/> white	NU346218	-	NU345118	NU345318	NU345218	NU345418	NU345618	NU345518	NU345018
<input type="checkbox"/> aluminium	NU346230	-	NU345130	NU345330	NU345230	NU345430	NU345630	NU345530	NU345030
<input type="checkbox"/> beige	NU346244	-	NU345144	-	-	NU345444	-	-	NU345044
<input type="checkbox"/> anthracite	NU346254	-	NU345154	NU345354	NU345254	NU345454	NU345654	NU345554	NU345054
1 module									
									
<input type="checkbox"/> white	NU346118	NU346818	-			-			-
<input type="checkbox"/> aluminium	NU346130	NU346830	-			-			-
<input type="checkbox"/> beige	-	NU346844							
<input type="checkbox"/> anthracite	NU346154	NU346854	-			-			-

	M-S	
2 modules		
		
<input type="checkbox"/> white	NU545718	
<input type="checkbox"/> aluminium	NU545730	
<input type="checkbox"/> anthracite	NU545754	

TV centre plates





	TV/FM	R-TV/SAT
2 modules		
		
<input type="checkbox"/> white	NU944018	NU944118
<input type="checkbox"/> aluminium	NU944030	NU944130
<input type="checkbox"/> beige	NU944044	-
<input type="checkbox"/> anthracite	NU944054	NU944154

Unica





Inserts

Other functions

Sound inserts

Loudspeakers connectors		Loudspeakers (for Bluetooth)	In-wall Bluetooth receiver	Volume control
	2 modules	1 module		
				
				
<input type="checkbox"/> white	NU348618	NU348718	NU360118	NU360218
<input type="checkbox"/> aluminium	NU348630	NU348730	NU360130	NU360230
<input type="checkbox"/> beige	NU348644	NU348744	-	NU360244
<input type="checkbox"/> anthracite	NU348654	NU348754	NU360154	NU360254
		NU3488		
Characteristics				
		<ul style="list-style-type: none"> 2 loudspeakers delivered with 2 cables (5 m, Φ 0.5 mm², red and white) Impedance: 8 Ω 	<ul style="list-style-type: none"> Audio receiver - 2 modules - voltage: 15-16 V DC Power supply - voltage: 93-265 V AC - frequency: 47-63 Hz 	
			Delivered with: <ul style="list-style-type: none"> audio receiver device power supply 	



Light signaling

Signaling light	
12-24 V DC	230 V AC
2 modules	
	
NU3773	NU3772
1 module	
	
NU3774	NU3775
<ul style="list-style-type: none"> Delivered with green and red papers to include under the centre plate. 	

Emergency light

Emergency light	
2 modules	
	
NU3776	
Characteristics	
<ul style="list-style-type: none"> 45 lux / 25 cm Integrated battery 230 V AC 	

Sound signaling

		Buzzer	Electronic doorbell
		2 modules	
			
<input type="checkbox"/> white	NU378518	NU378618	
<input type="checkbox"/> aluminium	NU378530	NU378630	
<input type="checkbox"/> beige	NU378544	NU378644	
<input type="checkbox"/> anthracite	NU378554	NU378654	
Characteristics			
		<ul style="list-style-type: none"> 230 V AC, 50/60 Hz Acoustic level: adjustable from 76 to 80 dB/1 m 	<ul style="list-style-type: none"> Acoustic level: 70 dB/1m 5 melodies Maximum connected in parallel to the output: <ul style="list-style-type: none"> - 10 without lamp - or 3 with lamp

Inserts

Other functions

WiFi repeater

WiFi repeater	
2 modules	
	
<input type="checkbox"/> white	NU360518
Characteristics	
<ul style="list-style-type: none"> Repeats the WiFi signal received from the Internet box to extend its receiving coverage in housing Time programming to define ranges for signal on and signal off Signal coverage: 15 m (indoor) Data speed: max 300 Mbps Communication standard: WiFi 802.11 b/g/n 2.4 GHz 100-240 V AC - 50/60 Hz Pairing mode: WPS (pairing method also featured on most routers) and through HTML pages 	

Bed side lamp

Lamp+USB charger type A	
	
<input type="checkbox"/> white	NU360318
<input type="checkbox"/> aluminium	NU360330
<input type="checkbox"/> beige	NU360344
<input type="checkbox"/> anthracite	NU360354
Characteristics	
<ul style="list-style-type: none"> Lamp 2 W USB 5 V DC - max 2.1 A 	

Cable Outlets

16 A	
2 modules	
	
<input type="checkbox"/> white	NU386218
<input type="checkbox"/> aluminium	NU386230
<input type="checkbox"/> beige	NU386244
<input type="checkbox"/> anthracite	NU386254
Characteristics	
<ul style="list-style-type: none"> cable diameter: from 6 to 12 mm 	

Protection









16 A	Fuse holder	Residual current device switch
1 module		
		
<input type="checkbox"/> white	NU363118	NU361218
<input type="checkbox"/> aluminium	NU363130	-
<input type="checkbox"/> anthracite	NU363154	-

Blind covers

Blind covers			
	2 modules	1 module	1/2 module (2 x)
			
<input type="checkbox"/> white	NU986618	NU986518	NU986418
<input type="checkbox"/> aluminium	NU986630	NU986530	NU986430
<input type="checkbox"/> beige	NU986644	NU986544	NU986444
<input type="checkbox"/> anthracite	NU986654	NU986554	NU986454

Dedicated trunking applications

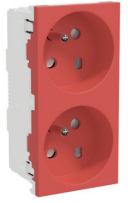
Sockets

	90°	45°			Surface	Tamperproof		
	2 modules	2 modules	4 modules	6 modules	2 modules	2 modules	4 modules	6 modules
								
<input type="checkbox"/> white	NU305920T	NU304918T	NU306918T	NU307918T	NU305218T	-	-	-
<input checked="" type="checkbox"/> red	NU305903T	NU304903T	NU306903T	NU307903T	NU305203T	NU305103T	NU306103T	NU307103T
Characteristics								
<ul style="list-style-type: none"> • 2P+E - 16 A - 250 V • With shutters • Screwless terminals (except NU305103T) 								

RJ45 centre plates

For S-One RJ45 connector straight	
2 modules	
	
<input type="checkbox"/> white	NU941118T
Characteristics	
<ul style="list-style-type: none"> • With shutter and label space 	

Unica Inserts with Fixing Frame

Content

Switches	72
Specialized controls	74
Comfort devices	75
Sockets	77
USB chargers	78
Data / Phone / TV	79
Other functions	81

Inserts with fixing frame

Switches

10 AX - 250 V AC switches

	Standard			With location lamp			IP44
	one-way	two-way	intermediate	one-way	two-way	intermediate	
2 modules							
□ white	NU520118	NU520318	NU520518	NU520118N	NU520318N	NU520518N	NU528218
■ aluminium	NU520130	NU520330	NU520530	NU520130N	NU520330N	NU520530N	NU528230
■ beige	NU520144	NU520344	NU520544	NU520144N	NU520344N	NU520544N	NU528244
■ anthracite	NU520154	NU520354	NU520554	NU520154N	NU520354N	NU520554N	NU528254
2 x 1 module							
□ white	NU521118	NU521318	NU521518	NU521118N	NU521318N	-	-
■ aluminium	NU521130	NU521330	NU521530	NU521130N	NU521330N	-	-
■ beige	NU521144	NU521344	NU521544	NU521144N	NU521344N	-	-
■ anthracite	NU521154	NU521354	NU521554	NU521154N	NU521354N	-	-
Characteristics							
<ul style="list-style-type: none"> • Connection: screwless terminals • Cables: 1 to 2.5 mm² rigid/flexible 						<ul style="list-style-type: none"> • Screwless terminals • Cables: 1 to 2.5 mm² rigid/flexible 	

10 AX - 250 V AC switches

	Control unit
2 modules	
□ white	NU521718
■ aluminium	NU521730
■ beige	NU521744
■ anthracite	NU521754

10 A - 250 V AC push-buttons

	NO	NO with location lamp
2 modules		
□ white	NU520618	NU520618N
■ aluminium	NU520630	NU520630N
■ beige	NU520644	NU520644N
■ anthracite	NU520654	NU520654N
Characteristics		
<ul style="list-style-type: none"> • Connection: screwless terminals • Cables: 1 to 2.5 mm² rigid/flexible • Lightable with NU9825A, NU9823AM and NU9825AZ LED lamps and rockers with visor 		

Inserts with fixing frame

Switches

16 AX - 250 V AC switches

	Standard 2 poles	With indication lamp 2 poles

2 modules

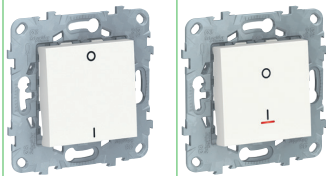

□ white	NU526218	NU526218S
■ aluminium	NU526230	NU526230S
■ beige	NU526244	NU526244S
■ anthracite	NU526254	NU526254S

Characteristics

- Connection: screw terminals
- Cables: 1 to 2,5 mm² rigid/flexible
- Lightable with NU9825A, NU9823AM and NU9825AZ LED lamps and rockers with visor

Accessories - Lamps

LED lamps	12-24 V DC white	250 V AC red	white
	NU9823AM	NU9825A	NU9825AZ

Characteristics

Consumption	0,15 mA	1,5 mA	0,05 mA
-------------	---------	--------	---------

Spring to transform a switch to push-button



S520299

Characteristics

- 10 units delivered with a positioning aid tool

Accessories - Rockers

Rockers	without symbol	with visor	for Unica with MGUx.xxx.xx references
---------	----------------	------------	--

2 modules



□ white	NU920018	NU920018N	NU920018U
■ aluminium	NU920030	NU920030N	NU920030U
■ beige	NU920044	NU920044N	NU920044U
■ anthracite	NU920054	NU920054N	NU920054U

1 module



□ white	NU910018	NU910018N	NU910018U
■ aluminium	NU910030	NU910030N	NU910030U
■ beige	NU910044	NU910044N	NU910044U
■ anthracite	NU910054	NU910054N	NU910054U

Inserts with fixing frame

Specialized controls

Shutters control

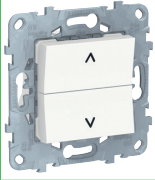
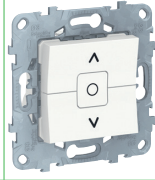
	Push-button - 6 A	Switch - 6 A
2 modules		
		
<input type="checkbox"/> white	NU520718	NU520818
<input type="checkbox"/> aluminium	NU520730	NU520830
<input type="checkbox"/> beige	NU520744	NU520844
<input type="checkbox"/> anthracite	NU520754	NU520854

Cord push-buttons

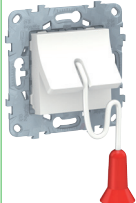
	10 A NO/NC
2 modules	
	
<input type="checkbox"/> white	NU522618
<input type="checkbox"/> beige	NU522644







Card push-buttons

	10 A NO/NC
2 modules	
	
<input type="checkbox"/> white	NU528318
<input type="checkbox"/> aluminium	NU528330
<input type="checkbox"/> beige	NU528344
<input type="checkbox"/> anthracite	NU528354



Inserts with fixing frame

Comfort devices

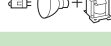
Dimmers

Universal		Compensation module LED
2 modules		
		
<input type="checkbox"/> white	NU551418	
<input type="checkbox"/> aluminium	NU551430	
<input type="checkbox"/> beige	NU551444	
<input type="checkbox"/> anthracite	NU551454	
Load compensation module		CCT90501
Maximum loads		
LED lamp 230 V 	RC: 5...100 VA RL: 5...20 VA	
incandescent lamp 230 V 	5...200 W	
halogen lamp 230 V 	5...150 W	
LV electronic halogen transformer lamps 12 V 	5...150 VA	
wound transformer lamps 12 V 	5...150 VA	
Characteristics		
<ul style="list-style-type: none"> Remote control by unlimited number of auxiliary push-button Automatic load detection Wire configuration without neutral Screw terminal connection Memory function Automatic overload protection, overheating protection, short-circuit protection 		<ul style="list-style-type: none"> Rated voltage: 230 VAC Frequency range: 50 - 60 Hz Power loss: 2 W max Installation: junction box, in the luminaire or in the sub-distribution panel, wired between neutral and dimmed phase.

Thermostats

	Room - 8 A	Floor - 10 A
2 modules		
		
<input type="checkbox"/> white	NU550118	NU550318
<input type="checkbox"/> aluminium	NU550130	NU550330
<input type="checkbox"/> beige	NU550144	NU550344
<input type="checkbox"/> anthracite	NU550154	NU550354
Characteristics		
	<ul style="list-style-type: none"> For heating and air-conditioning Settings range: + 5 to + 30 °C Blue and red LED's for conditioning or heating indication 	<ul style="list-style-type: none"> For floor heating Settings range: + 5 to + 45 °C Green LED for voltage supply indication Red LED for heating indication Delivered with a 4 m temperature sensor

Inserts with fixing frame

Comfort devices

Motion sensors

With push-button

2 modules



<input type="checkbox"/> white	NU552518
<input type="checkbox"/> aluminium	NU552530
<input type="checkbox"/> beige	NU552544
<input type="checkbox"/> anthracite	NU552554

Maximum loads

LED lamp 230 V		200 W
incandescent lamp 230 V		2200 W
halogen lamp 230 V		2000 W
motor (single-phase) 230 V		1000 VA
LV electronic halogen transformer		1050 VA
LV wound transformer		500 VA

Characteristics

- Rated current: 10 A
- Screw terminal connection
- Wire configuration without neutral
- Movement detection area: 8 m frontal, 8 m lateral
- Remote control by unlimited number of auxiliary push-button
- Automatic load detection
- Time delay range: 1...30 min
- Master/slave option; connecting two sensors together for covering larger area

Timers

Countdown timer relay - 10 A

2 modules

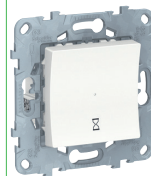

<input type="checkbox"/> white	NU553518
<input type="checkbox"/> aluminium	NU553530
<input type="checkbox"/> beige	NU553544
<input type="checkbox"/> anthracite	NU553554

Characteristics

- Time delay range: 5 min to 8 h
- Integrated status LED
- 3-wires (neutral required)

Unica

Inserts with fixing frame

Sockets

Side Earth sockets

	With shutters			Without shutters	
	screwless terminal	screw terminal	with lid	screwless terminal	screw terminal
2 modules					
white	NU505718	NU503718	NU503718TA	NU505618	NU503618
aluminium	NU505730	NU503730	NU503730TA	NU505630	NU503630
beige	NU505744	NU503744	NU503744TA	NU505644	NU503644
anthracite	NU505754	NU503754	NU503754TA	NU505654	NU503654
red	-	NU503703	-	-	-
Characteristics					
<ul style="list-style-type: none"> 2P+E - 16 A - 250 V 					

90°	IP44 frame	With USB charger
2 modules		
white	NU508218	NU501718
aluminium	NU508230	-
beige	NU508244	-
anthracite	NU508254	-
Characteristics		
<ul style="list-style-type: none"> 2P+E - 16 A - 250 V Screwless terminals Shuttered 		<ul style="list-style-type: none"> Screwless terminals Cables: 1 to 2.5 mm² rigid/flexible

Centres plates for Side Earth Sockets	
2 modules	
white	NU903718
aluminium	NU903730
beige	NU903744
anthracite	NU903754
For Unica MGU.....	
2 modules	
white	NU903718U
aluminium	NU903730U
beige	NU903744U
anthracite	NU903754U

Shaver sockets

20 VA	
white	MGU5.064.18
aluminium	MGU5.064.30
Characteristics	
<ul style="list-style-type: none"> 3 modules Input: 240 V Output: 115/240 V 	

	With cover frame	
	simple	double
white	NU203718	NU206718
aluminium	-	NU206730
beige	-	NU206744
anthracite	-	NU206754
Characteristics		
<ul style="list-style-type: none"> Screw terminal Installation in 1 gang box 		

European sockets

Simple	16 A	2 x 10 A
2 modules		
white	NU503318	NU503118
aluminium	NU503330	NU503130
beige	NU503344	NU503144
anthracite	NU503354	NU503154
Characteristics		
<ul style="list-style-type: none"> 2P - 250 V Screw terminal 		
Double with cover frame		
white	NU206318	
beige	NU206344	
Characteristics		
<ul style="list-style-type: none"> 2P - 16 A - 250 V Screw terminal Installation in 1 gang box 		

Inserts with fixing frame

USB chargers

USB chargers

	Charger type A	Charger type A+C		Charger type C		
2 modules						
white	NU541818	NU501818	NU501918	NU501318	NU501418	NU501718
aluminium	NU541830	NU501830	NU501930	NU501330	NU501430	-
beige	NU541844	NU501844	NU501944	NU501344	NU501444	-
anthracite	NU541854	NU501854	NU501954	NU501354	NU501454	-
Characteristics						
	<ul style="list-style-type: none"> • USB 2.0 • Output power: <ul style="list-style-type: none"> - NU5418●●: 5 V DC - 1.1 A + 2 A 	<ul style="list-style-type: none"> • Output power: <ul style="list-style-type: none"> - NU5018●●: 5 V DC - 1.2 A + 2.4 A 	<ul style="list-style-type: none"> • Output power: 18 W • 5V DC - 2.4 Max each port 	<ul style="list-style-type: none"> • Output power: <ul style="list-style-type: none"> Type C 45W + Type A 7.5W 	<ul style="list-style-type: none"> • Output power: 65 W 	<ul style="list-style-type: none"> • Socket outlet: 2P+E - 16 A - 250 V • Output power USB: 5V • Screwless terminals

Inserts with fixing frame

Data / Phone / TV

RJ45 data sockets

RJ45	Cat. 5e UTP zamak fixing frame	Cat. 6 UTP zamak fixing frame
------	-----------------------------------	----------------------------------

2 modules



<input type="checkbox"/> white	NU541118	NU541518
<input type="checkbox"/> aluminium	NU541130	NU541530
<input type="checkbox"/> beige	NU541144	NU541544
<input type="checkbox"/> anthracite	NU541154	NU541554

2 x1 module

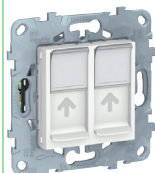

<input type="checkbox"/> white	NU542018	NU542418
<input type="checkbox"/> aluminium	NU542030	NU542430
<input type="checkbox"/> beige	NU542044	NU542444
<input type="checkbox"/> anthracite	NU542054	NU542454

Characteristics

- Connector Actassi S-One
- With shutter and label space

RJ45 Centre plates

	For Keystone/Systimax RJ45 connector straight
--	--

2 modules

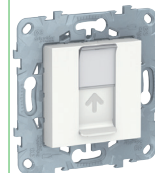

<input type="checkbox"/> white	NU546118
<input type="checkbox"/> aluminium	NU546130
<input type="checkbox"/> beige	NU546144
<input type="checkbox"/> anthracite	NU546154

Characteristics

- With shutter and label space

Telephone sockets

RJ11

2 modules

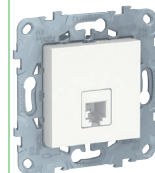

<input type="checkbox"/> white	NU549218
<input type="checkbox"/> aluminium	NU549230
<input type="checkbox"/> beige	NU549244
<input type="checkbox"/> anthracite	NU549254

Multimedia sockets

	HDMI	VGA + mini Jack	RCA	Data socket
--	------	--------------------	-----	-------------

2 x 1 module

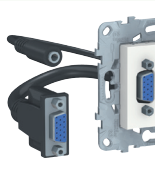

<input type="checkbox"/> white	NU543018	NU593218	NU543118	NU542718
<input type="checkbox"/> aluminium	NU543030	NU593230	NU543130	NU542730
<input type="checkbox"/> beige	NU543044	NU593244	NU543144	NU542744
<input type="checkbox"/> anthracite	NU543054	NU593254	NU543154	NU542754



Characteristics

<ul style="list-style-type: none"> • Connector prewired 	<ul style="list-style-type: none"> • Connector prewired • HD15 female • 3,5 mm connector 	<ul style="list-style-type: none"> • Video & audio • 3 connectors 	<ul style="list-style-type: none"> • Data transfer • Screws terminals
--	---	---	---



Inserts with fixing frame

Data / Phone / TV

TV sockets

	TV male			R-TV/SAT		
	individual	intermediate	terminal	individual	intermediate	terminal
2 modules						
						
<input type="checkbox"/> white	NU546218	NU546318	NU546418	NU545418	NU545618	NU545518
<input type="checkbox"/> aluminium	NU546230	NU546330	NU546430	NU545430	NU545630	NU545530
<input type="checkbox"/> beige	NU546244	NU546344	NU546444	NU545444	NU545644	NU545544
<input type="checkbox"/> anthracite	NU546254	NU546354	NU546454	NU545454	NU545654	NU545554

TV centre plates

	TV/FM	R-TV/SAT
2 modules		
		
<input type="checkbox"/> white	NU944018	NU944118
<input type="checkbox"/> aluminium	NU944030	NU944130
<input type="checkbox"/> beige	NU944044	-
<input type="checkbox"/> anthracite	NU944054	NU944154

Data and TV sockets

	Simple	RJ45 + TV
2 x 1 module		
		
<input type="checkbox"/> white	NU547018	
<input type="checkbox"/> aluminium	NU547030	
<input type="checkbox"/> anthracite	NU547054	
Characteristics		
<ul style="list-style-type: none"> • RJ45 cat. 6 UTP • TV male individual 		

Inserts with fixing frame

Other functions

Sound inserts

	Simple
	2 modules



<input type="checkbox"/> white	NU548618
<input type="checkbox"/> aluminium	NU548630
<input type="checkbox"/> beige	NU548644
<input type="checkbox"/> anthracite	NU548654

Light signalling

	Lamp and bell push-button
	2 modules

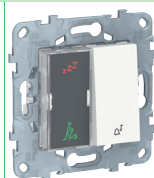

<input type="checkbox"/> white	NU577718
<input type="checkbox"/> aluminium	NU577730
<input type="checkbox"/> beige	NU577744
<input type="checkbox"/> anthracite	NU577754

Sound signalling

	Electronic programmable
	2 modules



<input type="checkbox"/> white	NU578618
<input type="checkbox"/> aluminium	NU578630
<input type="checkbox"/> beige	NU578644
<input type="checkbox"/> anthracite	NU578654

Characteristics

- 230 V AC, 50/60 Hz
- Acoustic level: 70 dB/1m
- 5 melodies
- Maximum connected in parallel to the output:
 - 10 without lamp
 - or 3 with lamp

Cable Outlets

	2 modules
--	------------------

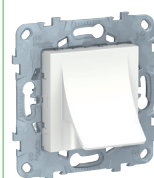

<input type="checkbox"/> white	NU586218
<input type="checkbox"/> aluminium	NU586230
<input type="checkbox"/> beige	NU586244
<input type="checkbox"/> anthracite	NU586254

Characteristics

- cable outer diameter: 12 mm

Blind covers

	2 modules
--	------------------

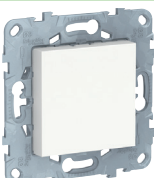

<input type="checkbox"/> white	NU586618
<input type="checkbox"/> aluminium	NU586630
<input type="checkbox"/> beige	NU586644
<input type="checkbox"/> anthracite	NU586654

Unica Inserts with Fixing Frame & Claws

Content

Switches	84
Sockets	86
Data / Phone / TV	87

Inserts with fixing frame and claws

Switches

10 AX - 250 V AC switches

	Standard			With location lamp	
	one-way	two-way	intermediate	one-way	two-way
2 modules					
<input type="checkbox"/> white	NU520118Z	NU520318Z	NU520518Z	NU520118NZ	NU520318NZ
<input type="checkbox"/> beige	NU520144Z	NU520344Z	-	-	-
2 x 1 module					
<input type="checkbox"/> white	NU521118Z			NU521118NZ	
<input type="checkbox"/> beige	NU521144Z			-	
Characteristics					
<ul style="list-style-type: none"> • Connection: screwless terminals • Cables: 1 to 2,5 mm² rigid/flexible • Lightable with NU9825A, NU9823AM and NU9825AZ LED lamps and rockers with visor 					



10 AX - 250 V AC push-buttons

	NO
2 modules	
<input type="checkbox"/> white	NU520618Z
<input type="checkbox"/> beige	NU520644Z
Characteristics	
<ul style="list-style-type: none"> • Connection: screwless terminals • Cables: 1 to 2,5 mm² rigid/flexible • Lightable with NU9825A, NU9823AM and NU9825AZ LED lamps and rockers with visor 	

Inserts with fixing frame and claws

Switches

Accessories - Lamps

LED lamps	12-24 V DC	250 V AC	
	white	red	white
			
	NU9823AM	NU9825A	NU9825AZ

Characteristics

Consumption	0.15 mA	1,5 mA	0,05 mA
-------------	---------	--------	---------

Spring to transform a switch to push-button

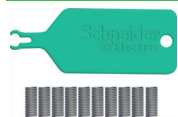







S520299

Characteristics

- 10 units delivered with a positioning aid tool

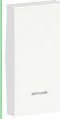

Accessories - Rockers

Rockers	without symbol	with visor	for Unica with MGUx.xxx.xx references
2 modules			
			
<input type="checkbox"/> white	NU920018	NU920018N	NU920018U
<input type="checkbox"/> aluminium	NU920030	NU920030N	NU920030U
<input type="checkbox"/> beige	NU920044	NU920044N	NU920044U
<input type="checkbox"/> anthracite	NU920054	NU920054N	NU920054U
1 module			
			
<input type="checkbox"/> white	NU910018	NU910018N	NU910018U
<input type="checkbox"/> aluminium	NU910030	NU910030N	NU910030U
<input type="checkbox"/> beige	NU910044	NU910044N	NU910044U
<input type="checkbox"/> anthracite	NU910054	NU910054N	NU910054U

Inserts with fixing frame and claws

Sockets

Side Earth sockets

	With Shutter Screw terminal	Without Shutter Screw terminal
2 modules		
		
<input type="checkbox"/> white	NU503718Z	NU503618Z
<input type="checkbox"/> beige	-	NU503644Z
Characteristics		
<ul style="list-style-type: none"> • 2P+E - 16 A - 250 V 		

Centres plates for Side Earth Sockets

2 modules	
	
<input type="checkbox"/> white	NU903718
<input type="checkbox"/> aluminium	NU903730
<input type="checkbox"/> beige	NU903744
<input type="checkbox"/> anthracite	NU903754

For Unica MGU●●●●●●

2 modules	
	
<input type="checkbox"/> white	NU903718U
<input type="checkbox"/> aluminium	NU903730U
<input type="checkbox"/> beige	NU903744U
<input type="checkbox"/> anthracite	NU903754U

Inserts with fixing frame and claws

Data / Phone / TV

RJ 45 data sockets

RJ45	Cat. 5e UTP zamak fixing frame
2 modules	



<input type="checkbox"/> white	NU541118Z
<input type="checkbox"/> beige	NU541144Z

Characteristics

- Connector Actassi S-One
- With shutter and label space

TV sockets

	TV male individual
2 modules	

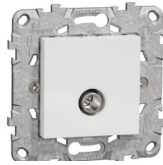

<input type="checkbox"/> white	NU546218Z
<input type="checkbox"/> beige	NU546244Z

Unica

Complete offer:

Inserts

with

Fixing Frame &

Cover Frame

Content

Switches 90

Sockets 91

Inserts with fixing frame and cover frame

Switches

10 AX - 250 V AC switches

	One-way	Two-way	Double one-way
with studio frame			
white	NU220118D	NU220318D	NU221118D
aluminium	NU220130D	NU220330D	NU221130D
beige	NU220144D	NU220344D	NU221144D
anthracite	NU220154D	NU220354D	NU221154D
Characteristics			
<ul style="list-style-type: none"> • Connection: screwless terminals • Cables: 1 to 2.5 mm² rigid/flexible • Lightable with NU9825A, NU9823AM and NU9825AZ LED lamps and rockers with visor 			

10 AX - 250 V AC push-buttons

	NO
2 modules	
white	NU220618D
beige	NU220644D
Characteristics	
<ul style="list-style-type: none"> • Connection: screwless terminals • Cables: 1 to 2.5 mm² rigid/flexible • Lightable with NU9825A, NU9823AM and NU9825AZ LED lamps and rockers with visor 	

Accessories - Lamps

LED lamps	12-24 V DC	250 V AC	
	White	Red	White
	NU9823AM	NU9825A	NU9825AZ
Characteristics			
Consumption	0.15 mA	1,5 mA	0,05 mA

Spring to transform a switch to push-button

S520299
Characteristics
<ul style="list-style-type: none"> • 10 units delivered with a positioning aid tool



Accessories - Rockers

Rockers	without symbol	with visor	for Unica MGU●●●●●●
2 modules			
white	NU920018	NU920018N	NU920018U
aluminium	NU920030	NU920030N	NU920030U
beige	NU920044	NU920044N	NU920044U
anthracite	NU920054	NU920054N	NU920054U
1 module			
white	NU910018	NU910018N	NU910018U
aluminium	NU910030	NU910030N	NU910030U
beige	NU910044	NU910044N	NU910044U
anthracite	NU910054	NU910054N	NU910054U

Inserts with fixing frame and cover frame

Sockets

Side Earth sockets

90°	IP44 frame with SO screws	With studio frame	With shutter and outer plate
2 modules			
			
<input type="checkbox"/> white	NU003718	NU203618D	NU203718
<input type="checkbox"/> aluminium	-	NU203630D	
<input type="checkbox"/> beige	NU003744	NU203644D	
<input type="checkbox"/> anthracite	-	NU203654D	
Characteristics			
<ul style="list-style-type: none"> • 2P+E - 16 A - 250 V 			

Unica

Installation:

Fixing Frame & Box

Content

Fixing frames	94
Boxes	96

Fixing frame and Box

Fixing frames

Fixing frames for CE60 boxes

1 gang or 2 modules			
Zamak	Plastic	Zamak with paint protector	Plastic with paint protector
NU7002	NU7002P	NU7002C	NU7002PC NU7002PCP ⁽¹⁾
⁽¹⁾ pack of 100 units			
Zamak with claws	Plastic with claws		
NU7002G	NU7002PG		
2 gangs or 4 modules	3 gangs or 6/8 modules	4 gangs or 10 modules	
Plastic with paint protector	Zamak with paint protector	Zamak with paint protector	
NU7004PC	NU7006C	NU7008C	

Fixing frames for rectangular boxes

3 modules		4 modules		7 modules
Zamak	Plastic	Zamak	Plastic	zamak
NU7103	NU7103P	NU7104	NU7104P	NU7107
Characteristics				
<ul style="list-style-type: none"> Delivered with paint protection 				

Fixing frames for British boxes



4 modules
NU7404

Unica

Fixing frame and Box

Fixing frames

Accessories

Claws	Paint protector	Adaptor
		
NU7892	NU7802	U0.582
Characteristics		
<ul style="list-style-type: none"> • For zamak fixing frames • With green plastic protection 	<ul style="list-style-type: none"> • For 2 modules 	<ul style="list-style-type: none"> • For MGU7.●●● fixing frames









Support for vertical installations	
2 modules	
	
<input type="checkbox"/> white	NU9580
Characteristics	
<ul style="list-style-type: none"> • to install inserts in vertical trunking in right position 	

Unica





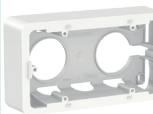

Fixing frame and Box

Boxes

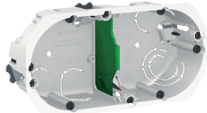
Surface boxes

	1 gang	2 gangs	3 gangs	3 modules	4 modules
For Unica Studio cover frames					
					
□ white	NU800218	NU800418	NU800618	NU810318	NU810418
■ beige	NU800244	NU800444	NU800644	-	-
For Unica Pro cover frames					
					
□ white	NU840218	NU840418	NU840618		
■ aluminium	NU840230	NU840430	NU840630		
■ anthracite	NU840254	NU840454	NU840654		

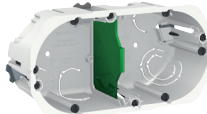
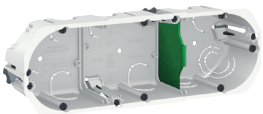
Multifix flush mounting boxes

1 gang	2 gangs	3 gangs	4 gangs
40 mm depth			
			
IMT35914 ⁽¹⁾ IMT35914P ⁽²⁾	IMT35924	IMT35934	IMT35944
50 mm depth			
			
IMT35915	IMT35925	IMT35935	IMT35945

(1) pack of 50 units.
(2) pack of 300 units.

Flush mounting boxes

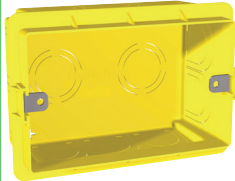
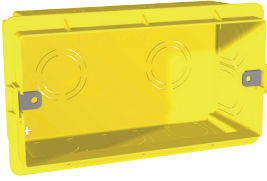
1 module	3 modules	4 modules
		
MGU8.601	MGU8.603	MGU8.604

Accessories

Divider	
	
IMT35994	IMT35995
Characteristics	
● for 40 mm depth boxes	● for 50 mm depth boxes



Unica

Cover Frames















Content

Standard cover frames	100
Special cover frames	106

Cover frames

Standard cover frames

Unica Studio

		white	aluminium	beige	anthracite
					
1 gang (2 mod.)		NU200218	NU200230	NU200244	NU200254
2 gangs (2 x 2 mod.)		NU200418	NU200430	NU200444	NU200454
3 gangs (4 x 2 mod.)		NU200618	NU200630	NU200644	NU200654
4 gangs (4 x 2 mod.)		NU200818	NU200830	NU200844	NU200854
5 gangs (4 x 2 mod.)		NU201018	NU201030	NU201044	NU201054
1 module		NU210118	NU210130	NU210144	NU210154
2 modules		NU210218	NU210230	NU210244	NU210254
3 modules		NU210318	NU210330	NU210344	NU210354
4 modules		NU210418	NU210430	NU210444	NU210454
7 modules		NU210718	NU210730	NU210744	NU210754

Unica

Cover frames

Standard cover frames

Unica Studio Color









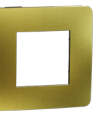

Front colour		light green		red	plum		chocolate		
Back colour		white	beige	white	white	beige	white	black	beige
1 gang (2 mod.)		NU280211	NU280212	NU280213	NU280214	NU280215	NU280216	NU280217	NU280219
2 gangs (2 x 2 mod.)		NU280411	NU280412	NU280413	NU280414	NU280415	NU280416	NU280417	NU280419
3 gangs (4 x 2 mod.)		NU280611	NU280612	NU280613	NU280614	NU280615	NU280616	NU280617	NU280619
4 gangs (4 x 2 mod.)		NU280811	NU280812	NU280813	NU280814	NU280815	NU280816	NU280817	NU280819
3 modules		NU270311	NU270312	NU270313	NU270314	NU270315	NU270316	NU270317	-
4 modules		NU270411	NU270412	NU270413	NU270414	NU270415	NU270416	NU270417	-
7 modules		NU270711	NU270712	NU270713	NU270714	NU270715	NU270716	NU270717	-
Front colour		white	dark grey		light grey	taupe			beige
Back colour		white	white	black	white	white	beige	black	beige
1 gang (2 mod.)		NU280218	NU280221	NU280222	NU280224	NU280226	NU280227	NU280228	NU280244
2 gangs (2 x 2 mod.)		NU280418	NU280421	NU280422	NU280424	NU280426	NU280427	NU280428	NU280444
3 gangs (4 x 2 mod.)		NU280618	NU280621	NU280622	NU280624	NU280626	NU280627	NU280628	NU280644
4 gangs (4 x 2 mod.)		NU280818	NU280821	NU280822	NU280824	NU280826	NU280827	NU280828	NU280844
3 modules		NU270318	NU270321	NU270322	NU270324	NU270326	NU270327	NU270328	NU270344
4 modules		NU270418	NU270421	NU270422	NU270424	NU270426	NU270427	NU270428	NU270444
7 modules		NU270718	NU270721	NU270722	NU270724	NU270726	NU270727	NU270728	-

Cover frames

Standard cover frames

Unica Studio Metal

Front colour	bronze			dark aluminium	white aluminium		copper	
Back colour	white	beige	black	black	white	black	white	black
								
1 gang (2 mod.)	 NU280250⁽¹⁾ NU280250M⁽²⁾	NU280251⁽¹⁾ NU280251M⁽²⁾	NU280252⁽¹⁾ NU280252M⁽²⁾	NU280253⁽¹⁾ NU280253M⁽²⁾	NU280255⁽¹⁾ NU280255M⁽²⁾	NU280256⁽¹⁾ NU280256M⁽²⁾	NU280257⁽¹⁾ NU280257M⁽²⁾	NU280258⁽¹⁾ NU280258M⁽²⁾
2 gangs (2 x 2 mod.)	 NU280450⁽¹⁾ NU280450M⁽²⁾	NU280451⁽¹⁾ NU280451M⁽²⁾	NU280452⁽¹⁾ NU280452M⁽²⁾	NU280453⁽¹⁾ NU280453M⁽²⁾	NU280455⁽¹⁾ NU280455M⁽²⁾	NU280456⁽¹⁾ NU280456M⁽²⁾	NU280457⁽¹⁾ NU280457M⁽²⁾	NU280458⁽¹⁾ NU280458M⁽²⁾
3 gangs (4 x 2 mod.)	 NU280650⁽¹⁾ NU280650M⁽²⁾	NU280651⁽¹⁾ NU280651M⁽²⁾	NU280652⁽¹⁾ NU280652M⁽²⁾	NU280653⁽¹⁾ NU280653M⁽²⁾	NU280655⁽¹⁾ NU280655M⁽²⁾	NU280656⁽¹⁾ NU280656M⁽²⁾	NU280657⁽¹⁾ NU280657M⁽²⁾	NU280658⁽¹⁾ NU280658M⁽²⁾
4 gangs (4 x 2 mod.)	 NU280850⁽¹⁾ NU280850M⁽²⁾	NU280851⁽¹⁾ NU280851M⁽²⁾	NU280852⁽¹⁾ NU280852M⁽²⁾	NU280853⁽¹⁾ NU280853M⁽²⁾	NU280855⁽¹⁾ NU280855M⁽²⁾	NU280856⁽¹⁾ NU280856M⁽²⁾	NU280857⁽¹⁾ NU280857M⁽²⁾	NU280858⁽¹⁾ NU280858M⁽²⁾
4 modules for double gang box			NU281452⁽¹⁾	NU281453⁽¹⁾	NU281455⁽¹⁾	NU281456⁽¹⁾		
3 modules		NU270350M⁽²⁾	NU270352M⁽²⁾	NU270353M⁽²⁾	NU270355M⁽²⁾	NU270356M⁽²⁾	NU270357M⁽²⁾	NU270358M⁽²⁾
4 modules		NU270450M⁽²⁾	NU270452M⁽²⁾	NU270453M⁽²⁾	NU270455M⁽²⁾	NU270456M⁽²⁾	NU270457M⁽²⁾	NU270458M⁽²⁾
7 modules		NU270750M⁽²⁾	NU270752M⁽²⁾	NU270753M⁽²⁾	NU270755M⁽²⁾	NU270756M⁽²⁾	NU270757M⁽²⁾	NU270758M⁽²⁾

Front colour	gold		
Back colour	white	beige	black
			
1 gang (2 mod.)	 NU280259⁽¹⁾ NU280259M⁽²⁾	NU280260⁽¹⁾ NU280260M⁽²⁾	NU280262⁽¹⁾ NU280262M⁽²⁾
2 gangs (2 x 2 mod.)	 NU280459⁽¹⁾ NU280459M⁽²⁾	NU280460⁽¹⁾ NU280460M⁽²⁾	NU280462⁽¹⁾ NU280462M⁽²⁾
3 gangs (4 x 2 mod.)	 NU280659⁽¹⁾ NU280659M⁽²⁾	NU280660⁽¹⁾ NU280660M⁽²⁾	NU280662⁽¹⁾ NU280662M⁽²⁾
4 gangs (4 x 2 mod.)	 NU280859⁽¹⁾ NU280859M⁽²⁾	NU280860⁽¹⁾ NU280860M⁽²⁾	NU280862⁽¹⁾ NU280862M⁽²⁾
3 modules		NU270359M⁽²⁾	NU270362M⁽²⁾
4 modules		NU270459M⁽²⁾	NU270462M⁽²⁾
7 modules		NU270759M⁽²⁾	NU270762M⁽²⁾













(1) Sand finish
(2) Mill finish



Unica

Cover frames

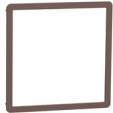
Standard cover frames

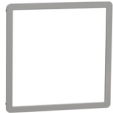
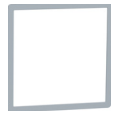
Unica Studio Outline

	white	yellow	red	plum	chocolate	light grey	aluminium	grey
								
1 gang 	NU230218	-	-	-	-	-	-	-
2 gangs 	NU230418	-	-	-	-	-	-	-
3 gangs 	NU230618	-	-	-	-	-	-	-
4 gangs 	NU230818	-	-	-	-	-	-	-
5 gangs 	NU231018	-	-	-	-	-	-	-
Inner frame								
								
	NU230018	NU230001	NU230013	NU230014	NU230016	NU230024	NU230030	NU230031

	beige	anthracite
		
Inner frame		
	NU230044	NU230054











Cover frames

Standard cover frames

Unica Pure

	aluminium	rubber	nordic Wood	wood oak	glass frosted white	glass frosted black	slate	translucide white
								
1 gang (2 mod.) 	NU600280	NU600282	NU600283	NU600284	NU600285	NU600286	NU600287	NU600289
2 gangs (2 x 2 mod.) 	NU600480	NU600482	NU600483	NU600484	NU600485	NU600486	NU600487	NU600489
	NU6004V80	NU6004V82	NU6004V83	NU6004V84	NU6004V85	NU6004V86	NU6004V87	NU6004V89
3 gangs (4 x 2 mod.) 	NU600680	NU600682	NU600683	NU600684	NU600685	NU600686	NU600687	NU600689
4 gangs (4 x 2 mod.) 	NU600880	NU600882	NU600883	NU600884	NU600885	NU600886	NU600887	NU600889
3 modules 	NU610380	NU610382	NU610383	NU610384	NU610385	NU610386	NU610387	NU610389

Unica Pro

	white	aluminium	anthracite
			
1 gang (2 mod.) 	NU400218 NU400218P ⁽¹⁾	NU400230	NU400254
2 gangs (2 x 2 mod.) 	NU400418	NU400430	NU400454
3 gangs (4 x 2 mod.) 	NU400618	NU400630	NU400654
4 gangs (4 x 2 mod.) 	NU400818	NU400830	NU400854
4 modules for double gang box 	NU411418	NU411430	NU411454
6 modules for triple gang box 	NU411618	NU411630	NU411654
8 modules for triple gang box 	NU411818	NU411830	NU411854
10 modules for quadruple gang box 	NU411018	NU411030	NU411054



(1) pack of 100 units

Unica

Cover frames

Standard cover frames

Unica Deco

		white	light grey	taupe	aluminium	anthracite
						
1 gang		NU600218	NU600224	NU600226	NU600230	NU600254
2 gangs		NU600418	NU600424	NU600426	NU600430	NU600454
3 gangs		NU600618	NU600624	NU600626	NU600630	NU600654
4 gangs		NU600818	NU600824	NU600826	NU600830	NU600854
5 gangs		NU601018	-	-	NU601030	NU601054

Cover frames

Special cover frames





Thin panels cover frames

	white	aluminium	anthracite
			
1 module 	NU200118	NU200130	NU200154

IP 44 cover frame

	white
	
1 gang (2 mod.) 	NU044218

IP55 cover frame and boxes for CE60

Box cover with lid	Boxes for surface mounting				
	1 gang	2 gangs, horizontal	2 gangs, vertical	3 gangs, horizontal	
					
<input type="checkbox"/> white	MUR39110	MUR39911	MUR39914	MUR39912	MUR39913
<input checked="" type="checkbox"/> anthracite	MUR35110	MUR37911	MUR37914	MUR37912	MUR37713

Characteristics

- IP55⁽¹⁾ - IK06
- IP55⁽²⁾ - IK08

(1) when installed in a box or frame.
 (2) when completed with covers.

Frames for flush mounting

	1 gang	1 gang, with claws	2 gangs, horizontal	2 gangs, vertical	3 gangs, horizontal
					
<input type="checkbox"/> white	MUR39107	MUR39108	MUR39101	MUR39151	MUR39109
<input checked="" type="checkbox"/> anthracite	MUR34107	MUR34108	MUR34101	MUR34151	MUR34109

Characteristics

- IP55⁽²⁾ (on flat/smooth walls only. IP44⁽²⁾ if mounted on uneven walls with MUR34007 ref.) / IK08.

(2) when completed with covers.

IP55 cover frame for rectangular boxes

	white	beige
		
3 module 	NU055318	NU055344
4 module 	NU055418	NU055444



Unica Wiser

Content

Wiser by SE 110







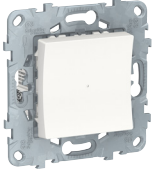



Wiser Home 113

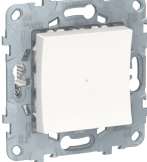

Relay switches

10 A	Modular	Assembled with Fixing Frame
2 modules		
		
<input type="checkbox"/> white	NU353818	NU553818
<input type="checkbox"/> aluminium	NU353830	NU553830
<input type="checkbox"/> beige	-	NU553844
<input type="checkbox"/> anthracite	NU353854	NU553854
Characteristics		
<ul style="list-style-type: none"> Relay switch for various purposes such as weekly scheduling using Wiser App, presence simulation, count down timer LED indicates when switch is on Remote control from smartphone or tablet using Wiser App Remote control by unlimited number of single mechanical push buttons 		
<p>Via Wiser app</p> <ul style="list-style-type: none"> Setting a timer: delay time (1 second - 24 hours), prewarning (with or without), manual switching (off or retrigger) Setting a time schedule (weekday switching, astro function, count-down timer, presence simulation). 		

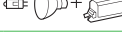
Dimmers







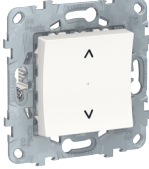

		Modular		Assembled with Fixing Frame		Compensation module LED
		Push-button	Rotary	Push-button	Rotary	
2 modules						
<input type="checkbox"/> white		NU351718	NU351818	NU551718	NU551818	
<input type="checkbox"/> aluminium		NU351730	NU351830	NU551730	NU551830	
<input type="checkbox"/> beige		-	-	NU551744	NU551844	
<input type="checkbox"/> anthracite		NU351754	NU351854	NU551754	NU551854	
Load compensation module						CCT90501
Maximum loads						
LED lamp 230 V		RC: 7...100 VA RL: 7...20 VA	RC: 7...100 VA RL: 7...20 VA	RC: 7...100 VA RL: 7...20 VA	RC: 7...100 VA RL: 7...20 VA	
incandescent lamp 230 V		14...200 W	14...200 W	14...200 W	14...200 W	
halogen lamp 230 V		14...150 W	14...150 W	14...150 W	14...150 W	
LV halogen lamps 12 V	electronic transformer 	14...150 W	14...150 W	14...150 W	14...150 W	
	wound transformer 	14...150 W	14...150 W	14...150 W	14...150 W	
Characteristics						
<ul style="list-style-type: none"> Remote control from auxiliary push-buttons Automatic load detection Wire configuration without neutral Memory function Automatic overload protection, overheating protection, short-circuit protection Additional functions like wake-up, fall asleep, scheduling and so on. Can be activated using the Wiser App Automatic load detection Brightness memory function Electronic overload, overheating and short-circuit protection 			<p>Via Wiser app</p> <ul style="list-style-type: none"> Remote control by unlimited number of single mechanical push buttons Setting the switch-on brightness or memory function (default setting) Setting the dimming range: minimum and maximum brightness Setting the LED operating mode manually (RL LED mode) Setting a timer or a time schedule 			<ul style="list-style-type: none"> Rated voltage: 230 VAC Frequency range: 50 - 60 Hz Power loss: 2 W max Installation: junction box, in the luminaire or in the sub-distribution panel, wired between neutral and dimmed phase.



Shutters control

	Modular	Assembled with Fixing Frame
2 modules		
<input type="checkbox"/> white	NU350918	NU550918
<input type="checkbox"/> aluminium	NU350930	-
<input type="checkbox"/> beige	NU350944	-
<input type="checkbox"/> anthracite	NU350954	-
Characteristics		
<ul style="list-style-type: none"> Control of blinds locally from the switch or remotely from smartphone or tablet using Wiser App Weekly scheduling Astro function Presence simulation Can be used for controlling up to 10 multiple relays, each controlling one blind motor Remote control by unlimited number of double push-buttons, distance: 50 m Protection of the motor against damage with two mutually electrically locked relay contacts Central control of multiple blind groups push buttons 		
Via Wiser app: <ul style="list-style-type: none"> Setting the blind movement time Management of blind and slat position Upgrade device firmware 		

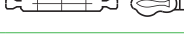
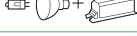
Motion sensors

		Modular		Assembled with Fixing Frame	
		with relay switch	with dimmer	with relay switch	with dimmer
2 modules					
<input type="checkbox"/> white		NU352618	NU352718	NU552618	NU552718
<input type="checkbox"/> aluminium		NU352630	NU352730	-	-
<input type="checkbox"/> beige		NU352644	NU352744	-	-
<input type="checkbox"/> anthracite		NU352654	NU352754	-	-
Maximum loads					
LED lamp 230 V		200 W	RC: 7...100 VA RL: 7...20 VA	200 W	RC: 7...100 VA RL: 7...20 VA
compact fluorescent lamp		200 W	-	200 W	-
incandescent lamp 230 V		2200 W	14...200 W	2200 W	14...200 W
halogen lamp 230 V		2000 W	14...150 W	2000 W	14...150 W
LV halogen lamps 12 V	electronic transformer 	1050 VA	14...150 W	1050 VA	14...150 W
	wound transformer 	500 VA	14...150 W	500 VA	14...150 W
Characteristics					
<ul style="list-style-type: none"> Wire configuration with neutral Movement detection area 8 m frontal, 8 m lateral Movement detection angle: 160 ° Configuration with time delay range, triggering light level... is done using the Wiser App Built-in push button switch for dim (only with dimmer version) and on/off switching Automatic mode: Automatic switching ON of loads when a motion is detected and dependent on the ambient brightness Manual operation: Local switching ON of loads when the switch is actuated, irrespective of the ambient brightness Semi-automatic mode: Manual switch-ON/automatic switch-OFF Remote control by unlimited number of single mechanical push buttons 					
Via Wiser app: <ul style="list-style-type: none"> Setting the detection brightness: 5 to 1000 lux (default setting 50 lux) Setting the detection sensitivity: High (default setting), medium or low Setting the detection sensitivity: High (default setting), medium or low Setting the overtravel time: 1 second to 30 minutes (default setting 5 minutes) Setting a timer or a time schedule 					
<ul style="list-style-type: none"> See Dimmers for others characteristics 					



Connected wireless switches

Assembled with Fixing Frame	
1-2 gangs	
	
<input type="checkbox"/> white	NU557118
<input type="checkbox"/> aluminium	NU557130
<input type="checkbox"/> beige	NU557144
<input type="checkbox"/> anthracite	NU557154

Connected sockets

16 A	German socket
	
<input type="checkbox"/> white	NU555718
<input type="checkbox"/> aluminium	NU555730
<input type="checkbox"/> beige	NU555744
<input type="checkbox"/> anthracite	NU555754









Relay switches

10 A		Modular	
2 modules			
			
<input type="checkbox"/> white	NU353718W		
<input type="checkbox"/> aluminium	NU353730W		
<input type="checkbox"/> graphite	NU353754W		
Characteristics			
<ul style="list-style-type: none"> Relay switch for various purposes such as weekly scheduling using Wiser App, presence simulation, count-down timer LED indicates when switch is on Remote control from smartphone or tablet using Wiser App Remote control by unlimited number of single mechanical push buttons 			
Via Wiser app			
<ul style="list-style-type: none"> Setting a timer: delay time (1 second - 24 hours), prewarning (with or without), manual switching (off or retrigger) Setting a time schedule (weekday switching, astro function, count-down timer, presence simulation). 			

Shutters control

		Modular	
2 modules			
			
<input type="checkbox"/> white	NU350818W		
<input type="checkbox"/> aluminium	NU350830W		
<input type="checkbox"/> anthracite	NU350854W		
Characteristics			
<ul style="list-style-type: none"> Control of blinds locally from the switch or remotely from smartphone or tablet using Wiser App Weekly scheduling Astro function Presence simulation Can be used for controlling up to 10 multiple relays, each controlling one blind motor Remote control by unlimited number of double push-buttons, distance: 50 m Protection of the motor against damage with two mutually electrically locked relay contacts Central control of multiple blind groups push buttons 			
Via Wiser app:			
<ul style="list-style-type: none"> Setting the blind movement time Management of blind and slat position Upgrade device firmware 			

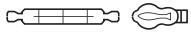
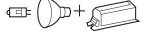
Dimmers

Modular		Compensation module LED		
2 modules		Push-button	Rotary	
				
<input type="checkbox"/> white		NU351518W	NU351618W	
<input type="checkbox"/> aluminium		NU351530W	NU351630W	
<input type="checkbox"/> graphite		NU351554W	NU351654W	
Load compensation module				CCT90501
Maximum loads				
LED lamp 230 V		RC: 7...100 VA RL: 7...20 VA	RC: 7...100 VA RL: 7...20 VA	
incandescent lamp 230 V		14...200 W	14...200 W	
halogen lamp 230 V		14...150 W	14...150 W	
LV halogen lamps 12 V	electronic transformer 	14...150 W	14...150 W	
	wound transformer 	14...150 W	14...150 W	
Characteristics				
<ul style="list-style-type: none"> Remote control from auxiliary push-buttons Automatic load detection Wire configuration without neutral Memory function Automatic overload protection, overheating protection, short-circuit protection Additional functions like wake-up, fall asleep, scheduling. Can be activated using the Wiser App Automatic load detection Brightness memory function Electronic overload, overheating and short-circuit protection 				<ul style="list-style-type: none"> Rated voltage: 230 VAC Frequency range: 50 - 60 Hz Power loss: 2 W max. Installation: junction box, in the luminaire or in the sub-distribution panel, wired between neutral and dimmed phase.
<ul style="list-style-type: none"> Via Wiser app Remote control by unlimited number of single mechanical push buttons Setting the switch-on brightness or memory function (default setting) Setting the dimming range: minimum and maximum brightness Setting the LED operating mode manually (RL LED mode) Setting a timer or a time schedule 				



Connected sockets

16 A	Pin Earth socket
	
<input type="checkbox"/> white	NU555918
<input type="checkbox"/> aluminium	NU555930
<input type="checkbox"/> anthracite	NU555954

Connected wireless switches

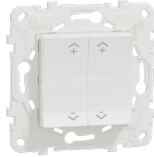
Modular	1-2 gangs
	
<input type="checkbox"/> white	NU557118W
<input type="checkbox"/> aluminium	NU557130W
<input type="checkbox"/> anthracite	NU557154W



Unica

KNX

Content

Controls

118

The following Unica control devices have to be connected to KNX bus line.
The KNX bus line is laid in parallel to the 230 V power supply.
When Unica sensor is activated, an actuator (e.g. the roller shutter control) will carry out all the switching commands required.

Introduction

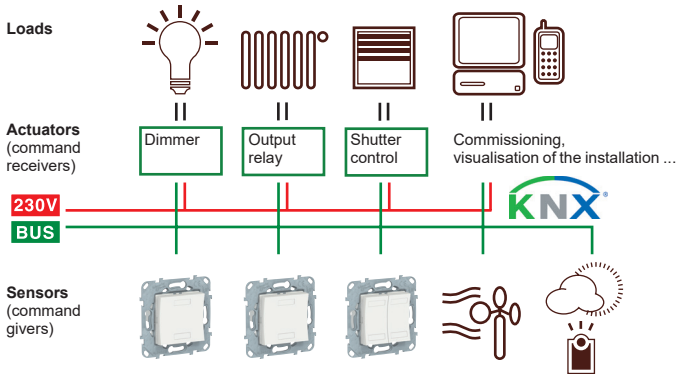

KNX Push-buttons

Push-buttons	2 buttons and 2 blue status LEDs, with screwless bus connecting terminals	4 buttons and 4 blue status LEDs, with screwless bus connecting terminals
2 modules		
<input type="checkbox"/> white	NU553018	NU553118
<input type="checkbox"/> white antibacterial	NU553020	NU553120
<input type="checkbox"/> aluminium	NU553030	NU553130
<input type="checkbox"/> anthracite	NU553054	NU553154
Characteristics		
	<ul style="list-style-type: none"> The status LED is located under the symbol window which can be taken off. With integrated bus coupler. The bus is connected using a bus connecting terminal. Contents: <ul style="list-style-type: none"> With set of 10 symbols: <ul style="list-style-type: none"> 2 x symbol with light opening, 1 x symbol "1", 1 x symbol "0", 2 x symbol for dimming, 2 x symbol for shutter, 2 x symbol (neutral). With bus connecting terminal. 	<ul style="list-style-type: none"> The status LED is located under the symbol window which can be taken off. With integrated bus coupler. The bus is connected using a bus connecting terminal. Contents: <ul style="list-style-type: none"> With set of 20 symbols: <ul style="list-style-type: none"> 4 x symbol with light opening, 2 x symbol "1", 2 x symbol "0", 4 x symbol for dimming, 4 x symbol for shutter, 4 x symbol (neutral). With bus connecting terminal.
KNX software functions: Switching, toggling, dimming (single/dual-surface), blind (single/dual-surface), pulse edges trigger 1-, 2-, 4- or 8-bit telegrams (distinction between short and long operation), pulse edges with 2-byte telegrams (distinction between short and long operation), 8-bit linear regulator, scene retrieval, scene saving, disable functions.		



Unica

Antibacterial offer

Content

Switches	122
Specialized controls	124
Comfort devices	125
Sockets	126
Sockets	127
Data / Phone / TV	128
Other functions	129
Wiser Home functions	130
KNX functions	131
Cover frames	132
System+	133

Unica

Antibacterial offer

Switches

10 AX - 250 V AC switches

	One-way	Two-way	Intermediate
2 modules			
<input type="checkbox"/> white antibacterial	NU320120	NU320320	NU320520
1 module			
<input type="checkbox"/> white antibacterial	NU310120	NU310320	NU310520
Characteristics			
<ul style="list-style-type: none"> • Connection: screwless terminals • Cables: 1 to 2,5 mm² rigid/flexible • Lightable with NU9825A, NU9823AM and NU9825AZ LED lamps and rockers with visor 			

10 A - 250 V AC push-buttons



	NO without symbol	NO/NC with label holder	NO with location lamp without symbol
2 modules			
<input type="checkbox"/> white antibacterial	NU320620	NU324620	NU320620N
1 module			
<input type="checkbox"/> white antibacterial	NU310620		
Characteristics			
<ul style="list-style-type: none"> • Connection: screwless terminals • Cables: 1.5 to 2.5 mm² rigid/flexible • Lightable with NU9825A, NU9823AM and NU9825AZ LED lamps and rockers with visor 			

Unica

Antibacterial offer

Switches

Accessories - Lamps

LED lamps	12-24 V DC	250 V AC	
	white	red	white
			
	NU9823AM	NU9825A	NU9825AZ
Characteristics			
Consumption	0.15 mA	1,5 mA	0,05 mA

Spring to transform a switch to push-button



S520299

Characteristics

- 10 units delivered with a positioning aid tool

Accessories - Rockers

Rockers	without symbol	with visor
2 modules		
		
<input type="checkbox"/> white antibacterial	NU920020	NU920020N
1 module		
		
<input type="checkbox"/> white antibacterial	NU910020	NU910020N

Unica

Antibacterial offer

Specialized controls

Fan control

Two-way - 10 A	
2 modules	
	
<input type="checkbox"/> white antibacterial	NU320320VMC

Roller blinds control

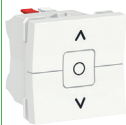
One-way - 6 A	
2 modules	
	
<input type="checkbox"/> white antibacterial	NU320820

Cord push-button







NO/NC - 10 A	
2 modules	
	
<input type="checkbox"/> white antibacterial	NU322620

Unica

Antibacterial offer

Comfort devices

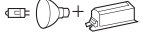
Dimmer

	Universal	Compensation module LED
2 modules		
<input type="checkbox"/> white antibacterial	NU351420	
Load compensation module		CCT90501
Maximum loads		
LED lamp 230 V 	RC: 5...100 VA RL : 5...20 VA	
incandescent lamp 230 V 	5...200 W	
halogen lamp 230 V 	5...150 W	
LV halogen lamps 12 V electronic transformer 	5...150 VA	
wound transformer 	5...150 VA	
Characteristics		
<ul style="list-style-type: none"> • Remote control by unlimited number of auxiliary push-button • Automatic load detection • Wire configuration without neutral • Screw terminal connection • Memory function • Automatic overload protection, overheating protection, short-circuit protection 		<ul style="list-style-type: none"> • Rated voltage: 230 VAC • Frequency range: 50 - 60 Hz • Power loss: 2 W max. • Installation: junction box, in the luminaire or in the sub-distribution panel, wired between neutral and dimmed phase.

Unica

Antibacterial offer



Sockets

Pin Earth sockets

90°	Standard	Surface	Tamperproof
2 modules			
			
<input type="checkbox"/> white antibacterial	NU305920	NU305220	-
<input checked="" type="checkbox"/> red	NU305903	NU305203	NU305103
<input checked="" type="checkbox"/> green	NU305906	NU305206	-

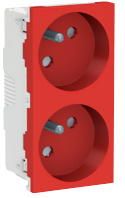
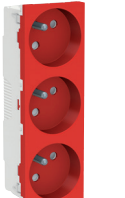

Characteristics

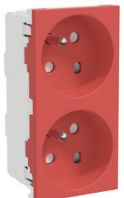
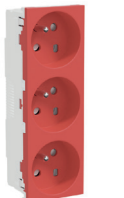
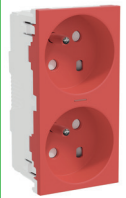
- 2P+E - 16 A - 250 V
- With shutters
- Screwless terminals (except NU305103)

45°	Standard			With lamp	Tamperproof		Tamperproof with lamp
	2 modules	4 modules	6 modules	4 modules	4 modules	6 modules	4 modules
							
<input type="checkbox"/> white antibacterial	NU304920	-	-	-	-	-	-
<input checked="" type="checkbox"/> red	NU304903	NU306903	NU307903	NU306903S	NU306103	NU307103	NU306103S
<input checked="" type="checkbox"/> green	NU304906	NU306906	NU307906	-	-	-	-

Characteristics

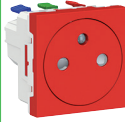
- 2P+E - 16 A - 250 V
- With shutters
- Screwless terminals

90°	Standard	Surface	Tamperproof
2 modules			
			
<input checked="" type="checkbox"/> red	NU305903T	NU305203T	NU305103T

Characteristics

- 2P+E - 16 A - 250 V
- With shutters
- Screwless terminals (except NU305103T)

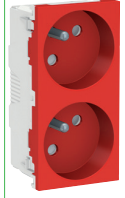
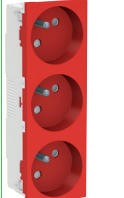
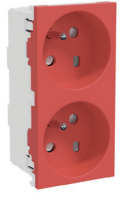
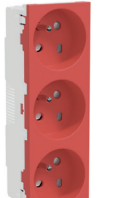
45°	Standard			Tamperproof	
	2 modules	4 modules	6 modules	4 modules	6 modules
					
<input checked="" type="checkbox"/> red	NU304903T	NU306903T	NU307903T	NU306103T	NU307103T

Characteristics

- 2P+E - 16 A - 250 V
- With shutters
- Screwless terminals

Unica

Antibacterial offer

Sockets

Side Earth sockets

Standard

2 modules



<input type="checkbox"/> white antibacterial	NU303720	NU305720
---	-----------------	-----------------

Characteristics

- | | |
|---|---|
| <ul style="list-style-type: none"> ● 2P+E - 16 A - 250 V ● With shutters ● Screw terminals | <ul style="list-style-type: none"> ● 2P+E - 16 A - 250 V ● With shutters ● Screwless terminals |
|---|---|

45°	Standard	With lamp
4 modules	Screw *	Screw *



<input type="checkbox"/> white	NU306720A	NU306720AS
--------------------------------	------------------	-------------------









Characteristics

- 2P+E - 16 A - 250 V
- * for Screw devices - Screw-IPT terminals
- With shutters

Antibacterial offer

Data / Phone / TV

RJ45 Centre plates

	For S-One RJ45 connector		RJ45 Cover Keystone/Systimax	RJ45 Cover 2 x Keystone/Systimax	RJ45 Cover 4 x Keystone/Systimax
	straight	inclined			
2 modules					
<input type="checkbox"/> white antibacterial	 NU941120	 NU940720	 NU946120	-	-
<input type="checkbox"/> white antibacterial	 NU942020	-	-	-	-
1 module					
<input type="checkbox"/> white antibacterial	 NU941020	 NU940620	 NU946020	-	-
4 modules					
<input type="checkbox"/> white antibacterial	-	-	-	 NU946220	 NU946320

Characteristics

- Straight : with shutter and label space
- Inclined : with label space

TV sockets

	TV Male, individual	FM/TV/SAT Individual (1 cable)
2 modules		
<input type="checkbox"/> white antibacterial	 NU346220	 NU345020
1 module		
<input type="checkbox"/> white antibacterial	 NU346120	-



TV centre plates

	R-TV/SAT
<input type="checkbox"/> white antibacterial	 NU944120

Antibacterial offer

Other functions

Blind covers

Blind covers	
2 modules	
	
<input type="checkbox"/> white antibacterial	NU986620
1 module	
	
<input type="checkbox"/> white antibacterial	NU986520

Antibacterial offer

Wiser Home functions



Download
Wiser App
Schneider Electric's connected
technology for homes



Relay switches

10 A

2 modules



white antibacterial **NU353720W**

Characteristics

- Relay switch for various purposes such as weekly scheduling using Wiser App, presence simulation, count-down timer
- LED indicates when switch is on
- Remote control from smartphone or tablet using Wiser App

Connected wireless switches

Modular

1-2 gangs

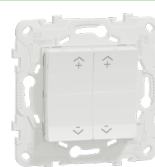

white antibacterial **NU557120W**

Dimmers

	Push-button	Rotary	Compensation module LED
2 modules			
<input type="checkbox"/> white antibacterial	NU351520W	NU351620W	
Load compensation module			CCT90501
Maximum loads			
LED lamp 230 V	RC: 7...100 VA RL : 7...20 VA	RC: 7...100 VA RL : 7...20 VA	
incandescent lamp 230 V	14...200 W	14...200 W	
halogen lamp 230 V	14...150 W	14...150 W	
LV halogen lamps 12 V	electronic transformer	14...150 W	14...150 W
	wound transformer	14...150 W	14...150 W
Characteristics			
<ul style="list-style-type: none"> • Remote control from auxiliary push-buttons • Automatic load detection • Wire configuration without neutral • Memory function • Automatic overload protection, overheating protection, short-circuit protection • Additional functions like wake-up, fall asleep, scheduling... can be activated using the Wiser App 			<ul style="list-style-type: none"> • Rated voltage: 230 VAC • Frequency range: 50 - 60 Hz • Power loss: 2 W max. • Installation: junction box, in the luminaire or in the sub-distribution panel, wired between neutral and dimmed phase.



white antibacterial

NU351520W

NU351620W

Load compensation module

CCT90501

Maximum loads

LED lamp 230 V	RC: 7...100 VA RL : 7...20 VA	RC: 7...100 VA RL : 7...20 VA
incandescent lamp 230 V	14...200 W	14...200 W
halogen lamp 230 V	14...150 W	14...150 W
LV halogen lamps 12 V	electronic transformer	14...150 W
	wound transformer	14...150 W

Characteristics

- Remote control from auxiliary push-buttons
- Automatic load detection
- Wire configuration without neutral
- Memory function
- Automatic overload protection, overheating protection, short-circuit protection
- Additional functions like wake-up, fall asleep, scheduling... can be activated using the Wiser App
- Rated voltage: 230 VAC
- Frequency range: 50 - 60 Hz
- Power loss: 2 W max.
- Installation: junction box, in the luminaire or in the sub-distribution panel, wired between neutral and dimmed phase.

Shutters control

Wiser France

2 modules



white antibacterial **NU350820W**

Characteristics

- Control of blinds locally from the switch or remotely from smartphone or tablet using Wiser App
- Weekly scheduling
- Astro function
- Presence simulation
- Can be used for controlling up to 10 multiple relays, each controlling one blind motor



Unica

Antibacterial offer

KNX functions



KNX Push-buttons







Push-buttons	2 buttons and 2 blue status LEDs, with screwless bus connecting terminals	4 buttons and 4 blue status LEDs, with screwless bus connecting terminals
2 modules		
		
<input type="checkbox"/> white antibacterial	NU553020	NU553120
Characteristics		
	<ul style="list-style-type: none"> The status LED is located under the symbol window which can be taken off. With integrated bus coupler. The bus is connected using a bus connecting terminal. Contents: <ul style="list-style-type: none"> With set of 10 symbols: <ul style="list-style-type: none"> - 2 x symbol with light opening, - 1 x symbol "1", - 1 x symbol "0", - 2 x symbol for dimming, - 2 x symbol for shutter, - 2 x symbol (neutral). With bus connecting terminal. 	<ul style="list-style-type: none"> The status LED is located under the symbol window which can be taken off. With integrated bus coupler. The bus is connected using a bus connecting terminal. Contents: <ul style="list-style-type: none"> With set of 20 symbols: <ul style="list-style-type: none"> - 4 x symbol with light opening, - 2 x symbol "1", - 2 x symbol "0", - 4 x symbol for dimming, - 4 x symbol for shutter, - 4 x symbol (neutral). With bus connecting terminal.
	KNX software functions: Switching, toggling, dimming (single/dual-surface), blind (single/dual-surface), pulse edges trigger 1-, 2-, 4- or 8-bit telegrams (distinction between short and long operation), pulse edges with 2-byte telegrams (distinction between short and long operation), 8-bit linear regulator, scene retrieval, scene saving, disable functions.	

Unica

Antibacterial offer

Cover frames

Unica Pro





		white antibacterial
		
1 gang (2 mod.)		NU400220
2 gangs (2 x 2 mod.)		NU400420
3 gangs (3 x 2 mod.)		NU400620
4 modules		NU411420
6 modules		NU411620

Unica



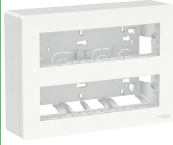

Antibacterial offer

System+



Surface mounting workstations

	2 rows x 8 modules	2 rows x 10 modules	2 columns	3 columns	4 columns
					
white antibacterial	NU121820	NU121020	NU122420	NU123420	NU124420

Flush mounting workstations

	2 rows x 8 modules	2 rows x 10 modules	3 columns
			
white antibacterial	NU171820	NU171020	NU173420

Horizontal cover frames

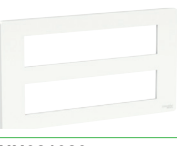
	2 rows x 8 modules	2 rows x 10 modules
Cover frames		
		
white antibacterial	NU021820	NU021020

Horizontal surface boxes

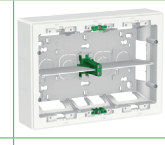
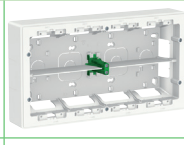
	2 rows x 8 modules	2 rows x 10 modules
Surface boxes		
		
white antibacterial	NU821820	NU821020

Unica System+



Content

Complete workstations	136
Horizontal centralizations	137
Vertical centralizations	138
Accessories	139



Unica System+

Complete workstations



Horizontal surface mounting workstations

	2 rows x 8 modules	2 rows x 10 modules
	NU121820	NU121020
	NU121830	NU121030
	NU121854	NU121054



Vertical surface mounting workstations

	2 columns x 4 modules	3 columns x 4 modules	4 columns x 4 modules
	NU122418	NU123418	NU124418
	NU122430	NU123430	NU124430
	NU122454	NU123454	NU124454

Horizontal flush mounting workstations

	2 rows x 8 modules	2 rows x 10 modules
	NU171820	NU171020
	NU171830	NU171030
	NU171854	NU171054

Vertical flush mounting workstations

	2 columns x 4 modules	3 columns x 4 modules	4 columns x 4 modules
	NU172418	NU173418	NU174418
	NU172430	NU173430	NU174430
	NU172454	NU173454	NU174454

Unica System+

Horizontal centralizations

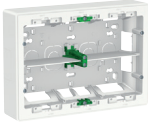
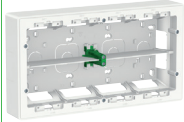

Surface mounting boxes

	3 gang 8 modules	4 gang 10 modules
		
□ white	NU821820	NU821020
■ aluminium	NU821830	NU821030
■ anthracite	NU821854	NU821054

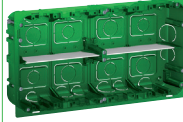
Flush mounting boxes

	3 gang 8 modules	4 gang 10 modules
		
	NU8718	NU8710

Cover frames

	2 row x 8 module	2 row x 10 module
Cover frame with fixing frame		
		
□ white	NU021820	NU021020
■ aluminium	NU021830	NU021030
■ anthracite	NU021854	NU021054

Unica System+

Vertical centralizations

Surface mounting boxes

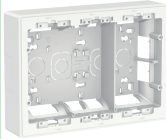
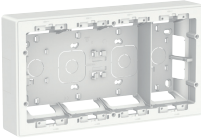
	2 columns x 4 modules	3 columns x 4 modules	4 columns x 4 modules
			
<input type="checkbox"/> white	NU822418	NU823418	NU824418

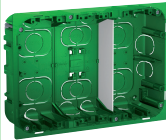
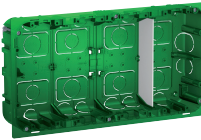

Flush mounting boxes

	2 columns x 4 modules	3 columns x 4 modules	4 columns x 4 modules
			
	NU8724	NU8734	NU8744

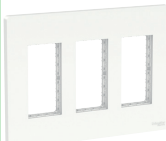
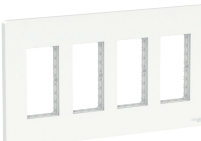
Cover frames

	2 columns	3 columns	4 columns
Cover frame with fixing frame			
			
<input type="checkbox"/> white	NU022418	NU023418	NU024418





Kits (inserts with cover frames)

	2 columns	3 columns	4 columns
			
<input type="checkbox"/> white	NU112118 <ul style="list-style-type: none"> • 2 German sockets-outlets + 2 Centre plates without RJ45 connectors 	NU113118 <ul style="list-style-type: none"> • 2 German sockets-outlets + 2 German red sockets-outlets + 2 Centre plates without RJ45 connectors 	NU114118 <ul style="list-style-type: none"> • 4 German sockets-outlets + 2 German red sockets-outlets + 2 Centre plates without RJ45 connectors

Unica System+

Accessories

Mounting accessories

Link accessory for surface workstation	Fixing frame	Metal divider for flush mounting boxes		DIN rail adapter
				
U22.805	NU7204P	NU9802	NU9801	NU9800
Characteristics				
	<ul style="list-style-type: none"> for vertical solutions 			<ul style="list-style-type: none"> for Acti9 devices installation (1 or 2 modules of 18 mm)

Unica

Technical
Information

Content

Dimensions 142

Fixing frames 142

Cover frames 144

Fixing frames and Cover frames 145

Boxes 146

Connections 149

Switches 149

Comfort devices 152

Sockets 153

Wiser 154

Data / Phone / TV 155

USB chargers 156

Other functions 157

RJ45 data sockets 159

Unica

Dimensions

Fixing frames

Universal fixing frame

NU7002●●

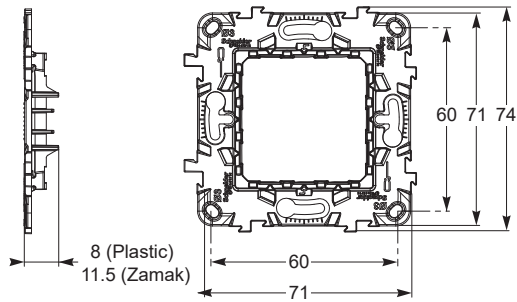

Zamak and plastic (2 modules)

NU7103●●

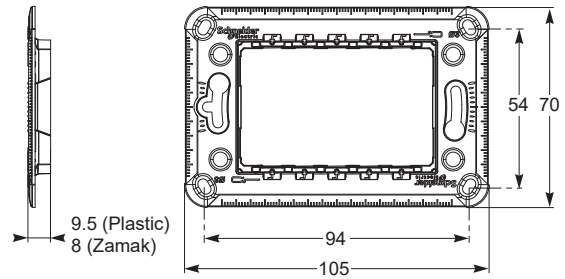

Zamak and plastic (3 modules)

NU7104●●

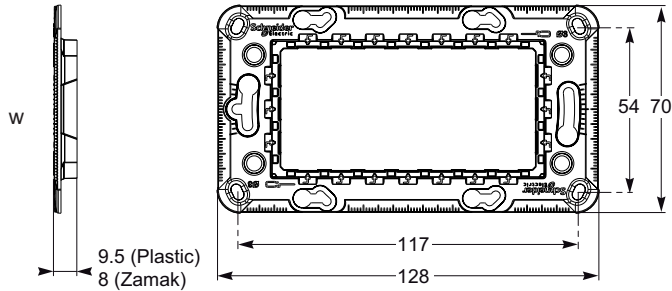

Zamak and plastic (4 modules)

NU7107

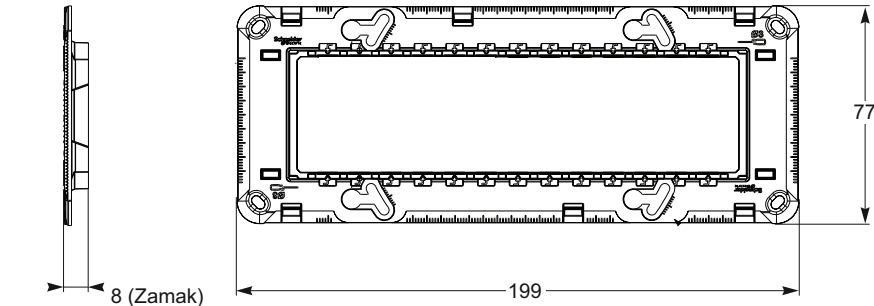

Zamak (7 modules)

Unica

Dimensions

Fixing frames

Multigang fixing frames

NU7004PC

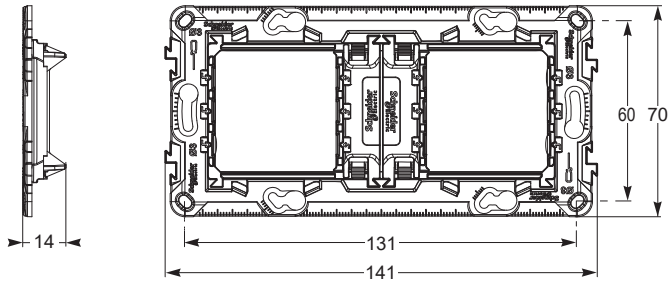

Plastic (2 gangs or 4 modules)

NU7006C

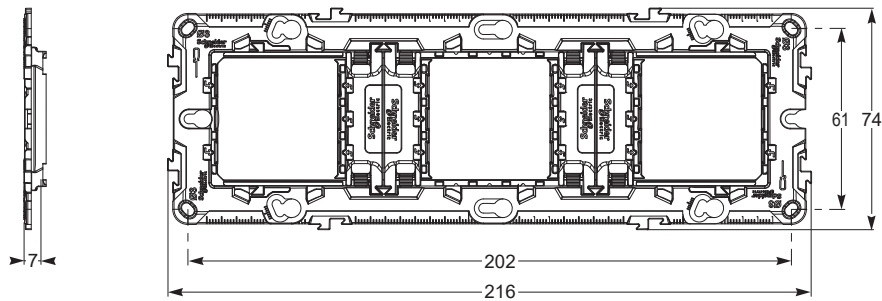

Zamak (3 gangs or 6/8 modules)

NU7008C

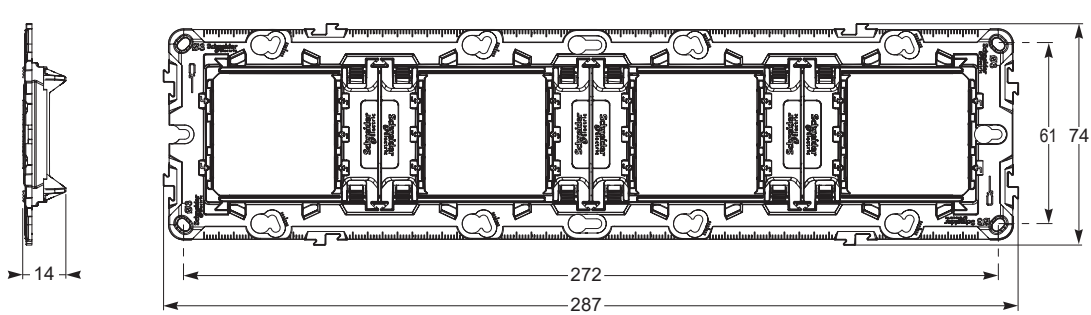

Zamak (4 gangs or 10 modules)

Unica

Dimensions

Cover frames

Gangs

NU200●●●
NU280●●●

NU600●●●

NU400●●●

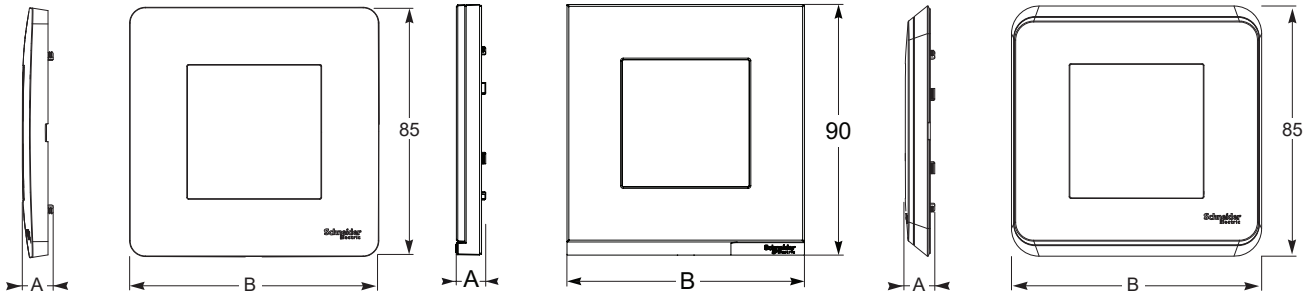

Unica Studio

Unica Pure

Unica Pro

Type	Depth	1 gang	2 gangs	3 gangs	4 gangs	5 gangs
	A	B	B	B	B	B
Unica Studio	10	85	156	227	298	369
Unica Pure	10	85	156	227	298	-
Unica Pro	10	85	156	227	298	-

Modules

NU210●●●
NU270●●●

NU411●●●

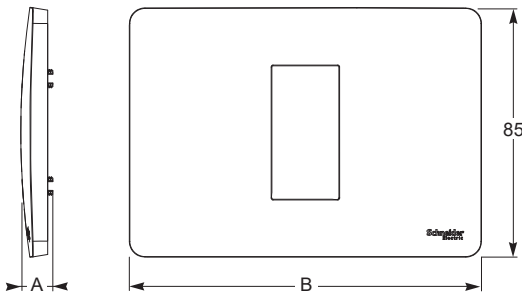

Unica Studio
Unica Studio Color
Unica Studio Metal

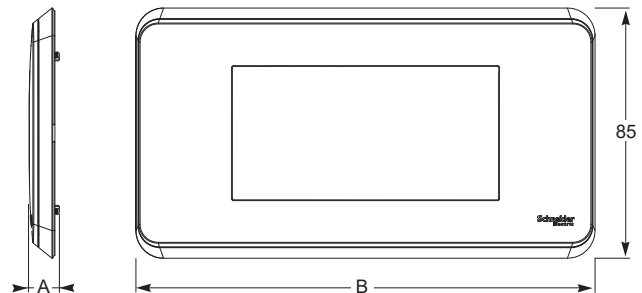

Unica Pro

Type	Depth	1, 2, 3 modules	4 modules	7 modules
	A	B	B	B
Unica Studio	10	120	142	210

Type	Depth	4 modules	6, 8 modules	10 modules
	A	B	B	B
Unica Pro	10	156	227	298

NU6103●●

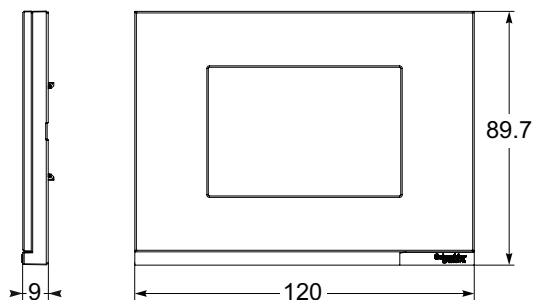

Unica Pure

IP55 frames

NU055●●●

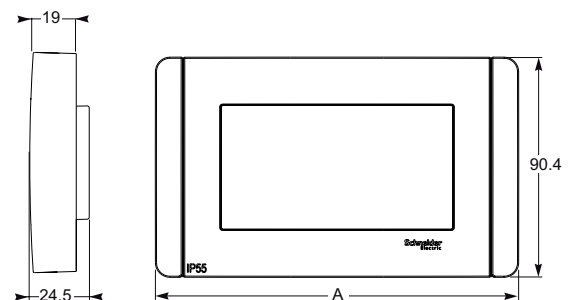

Type	3 modules	4 modules
	A	A
IP55	126	148.5

Dimensions

Fixing frames and Cover frames

Fixing frames

NU7204P

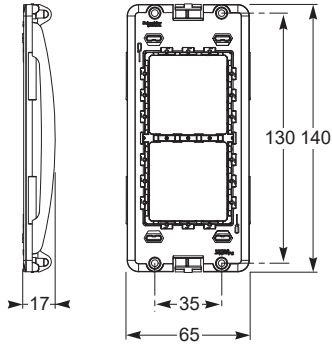

Cover frames

NU0218●●: 3 gangs - 6 or 8 modules
 NU0210●●: 4 gangs - 10 modules

NU02●418: 2,3 and 4 columns - 4 modules

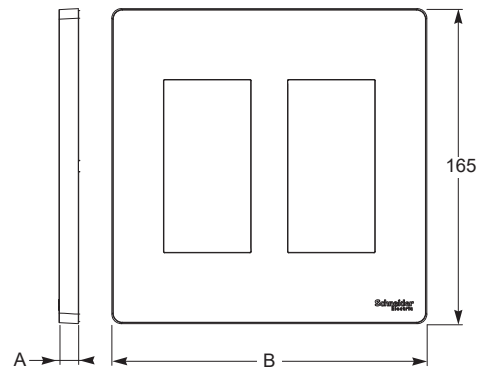
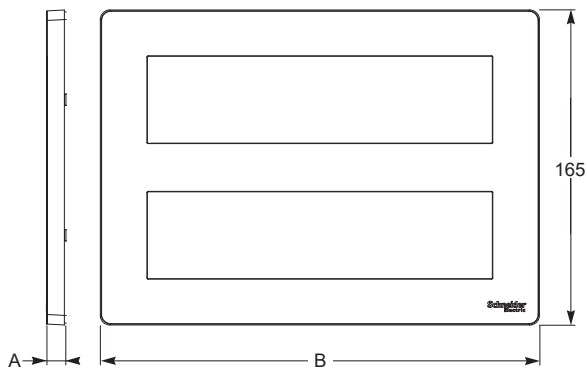

Horizontal cover frame

Vertical cover frame

Type	Depth	3 gangs 6 or 8 modules	4 gangs 10 modules	2 columns 4 modules	3 columns 4 modules	4 columns 4 modules
	A	B	B	B	B	B
Cover frames	10	230	300	165	230	300

Surface mounting boxes

NU800xyy

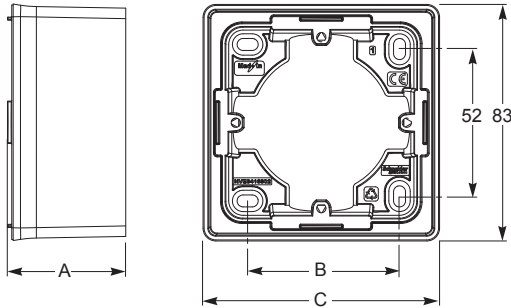

NU840xyy

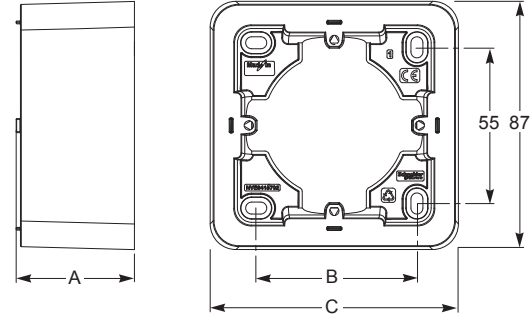

Unica Studio surface mounting boxes

Unica Pro surface mounting boxes

Type	Depth	1 gang		2 gangs		3 gangs	
		A	B	C	B	C	B
Unica Studio	41.5	53	83	124	154	195	224
Unica Pro	41.5	56	87	128	158	199	229

Where x denotes the length of surface mounting boxes.
Where yy denotes the color of surface mounting boxes...

Flush mounting boxes

IMT359●4: 40 mm depth
IMT359●5: 50 mm depth

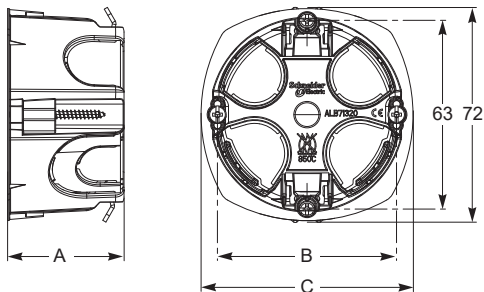

Multifix flush mounting boxes

Type	Depth		1 gang		2 gangs		3 gangs		4 gangs	
	IMT359●4	IMT359●5	B	C	B	C	B	C	B	C
Multifix	40	50	60	71	71	141.5	71 x 2	212,5	71 x 3	283

MGU8.601: 35 mm depth
MGU8.603, MGU8.604: 48 mm depth

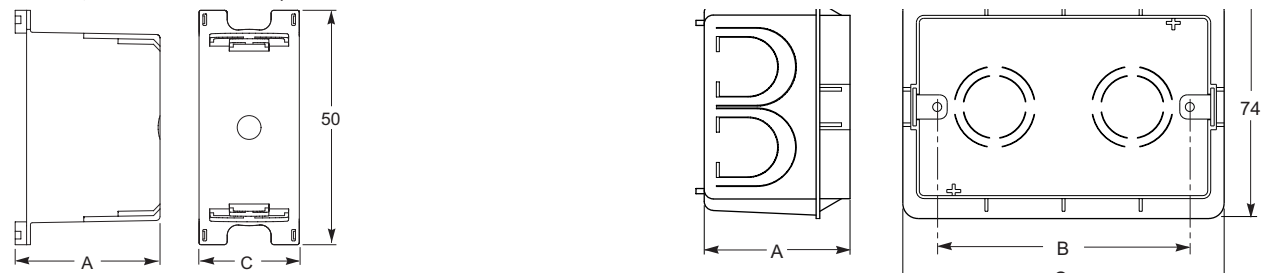

Flush mounting boxes

Type	Depth		1 module		3 modules		4 modules	
	MGU8.601	MGU8.603/604	C	B	C	B	C	
Box	35	48	26.5	83.5	106	108	131	

Flush mounting boxes

NU8718••: 3 gangs - 6 or 8 modules
NU8710••: 4 gangs - 10 modules

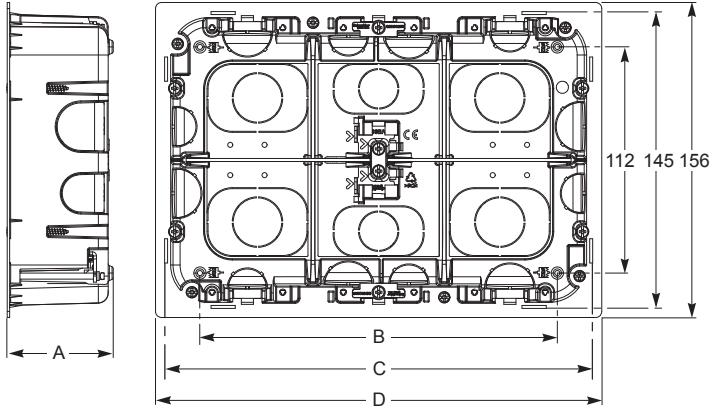

Horizontal flush centralization boxes

NU87•4: 2,3 and 4 columns - 8 modules

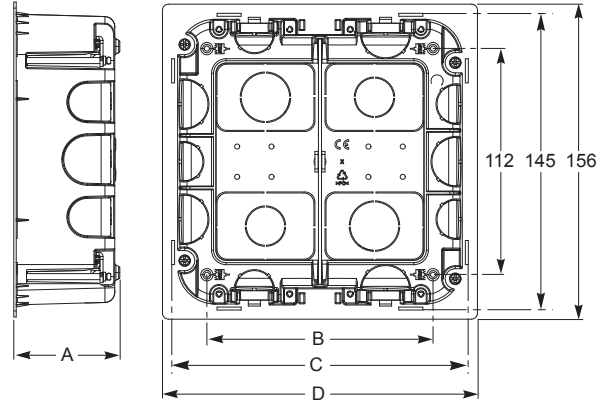

Vertical flush centralization boxes

Type	Depth	3 gangs 6 or 8 modules			4 gangs 10 modules			2 columns 4 modules			3 columns 4 modules			4 columns 4 modules		
		A	B	C	D	B	C	D	B	C	D	B	C	D		
Flush mounting boxes	52.5	177	210	221	242	281	292	112	145	156	177	210	221	242	281	292

Centralization boxes

NU8218••: 3 gangs - 6 or 8 modules
NU8210••: 4 gangs - 10 modules

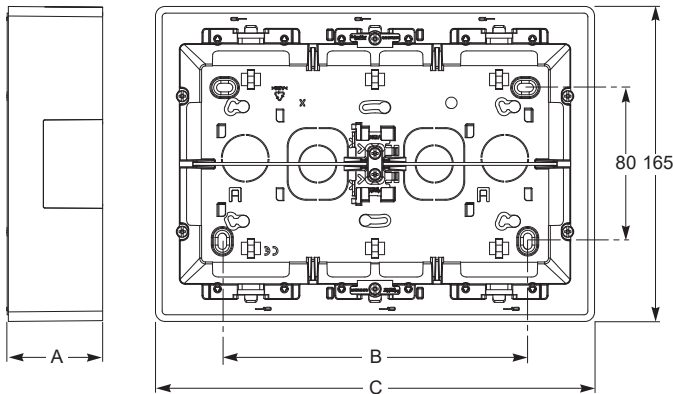

Horizontal centralization boxes

NU82•418: 2,3 and 4 columns - 8 modules

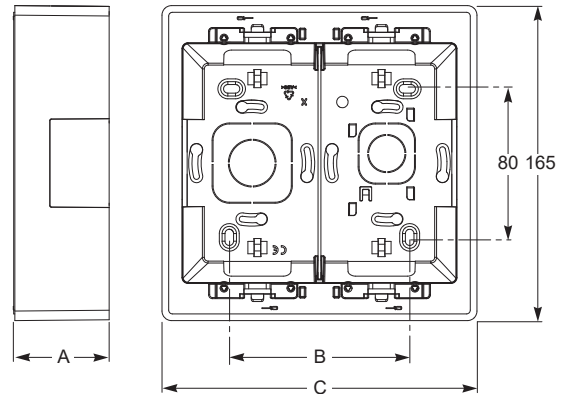

Vertical centralization boxes

Type	Depth	3 gangs 6 or 8 modules		4 gangs 10 modules		2 columns 4 modules		3 columns 4 modules		4 columns 4 modules	
		A	B	C	B	C	B	C	B	C	
Centralization boxes	50	160	230	233	300	94.5	165	160	230	233	300

Flush mounting workstations boxes

NU171●20: 2 rows - 8 or 10 modules

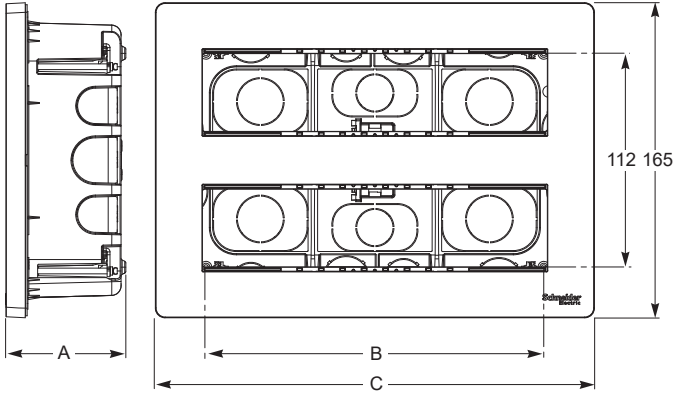

Horizontal flush mounting workstations boxes

NU17●418: 2,3 and 4 columns - 8 modules

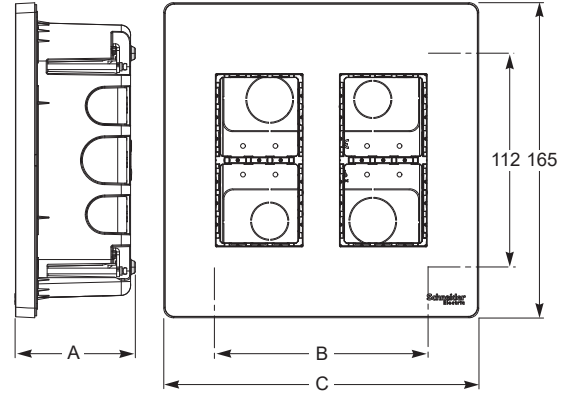

Vertical flush mounting workstations boxes

Type	Depth	2 rows 8 modules		2 rows 10 modules		2 columns 4 modules		3 columns 4 modules		4 columns 4 modules	
		A	B	C	B	C	B	C	B	C	B
Flush mounting workstations boxes	63	177	230	248	300	112	165	177	230	248	300

Surface workstations boxes

NU121●20: 2 rows - 8 or 10 modules

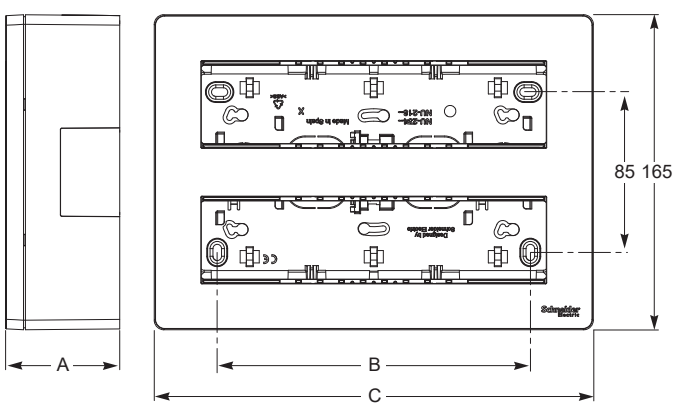

Horizontal surface workstations boxes

NU12●418: 2,3 and 4 columns - 8 modules

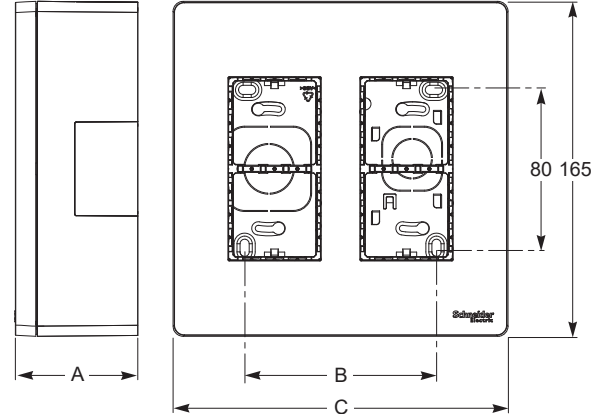

Vertical surface workstations boxes

Type	Depth	2 rows 8 modules		2 rows 10 modules		2 columns 4 modules		3 columns 4 modules		4 columns 4 modules	
		A	B	C	B	C	B	C	B	C	B
Surface workstations boxes	60	160	230	233	300	94.5	165	160	230	233	300

Unica

Connections

Switches

Switches and push-buttons

Connection examples

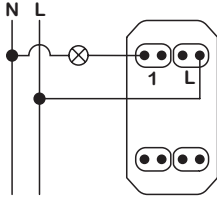

1 module - One-way switch
Push-button

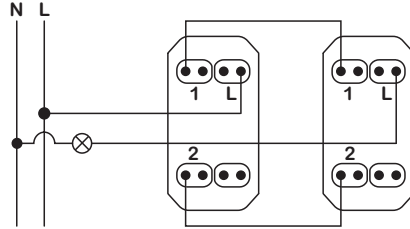

1 module - 2 two-way switches

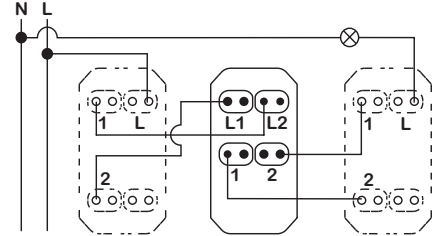

1 module - 2 two-way switches + 1 intermediate switch

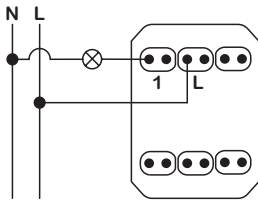

2 modules - One-way switch
Push-button

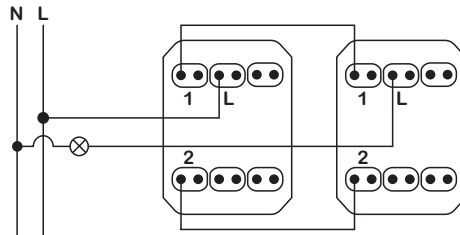

2 modules - Two-way switch

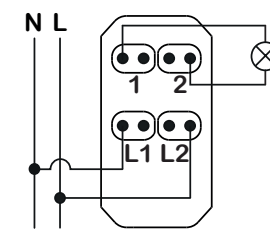

2 poles switch

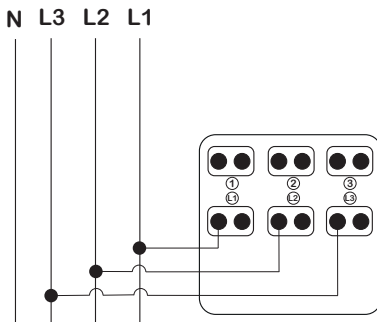

3 poles switch

Switches and push-buttons with indication lamp

Connection examples

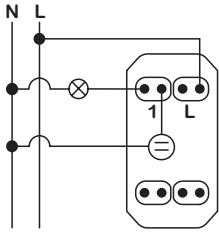

1 module - One-way switch with indication lamp

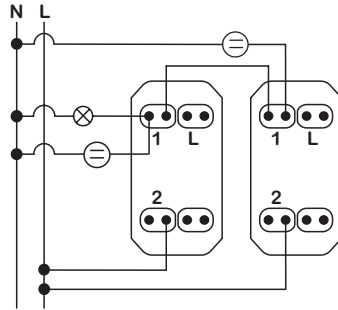

1 module - 2 two-way switches with indication lamp

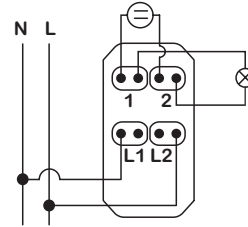

Double pole switch with indication lamp

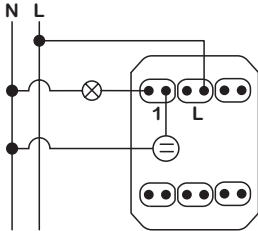

2 modules - One-way switch with indication lamp

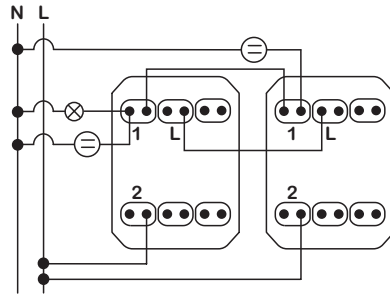

2 modules - 2 two-way switches with indication lamp

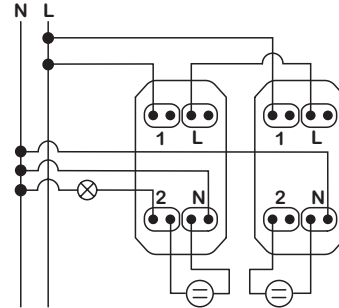

1 module - 2 two-way switches with indication lamp and neutral connection

Unica Connections Switches

Switches and push-buttons with location lamp

Connection examples

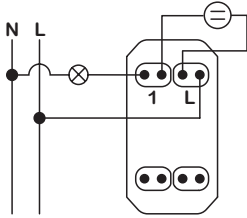

1 module - One-way switch and push-button with location lamp

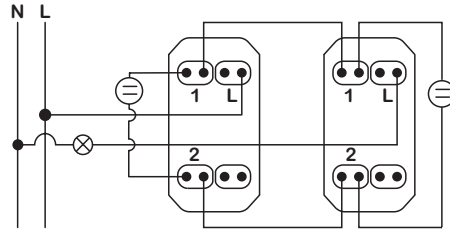

1 module - 2 two-way switches with location lamp

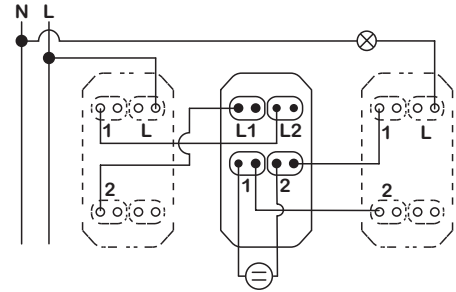

1 module - 2 two-way switches + 1 intermediate with location lamp

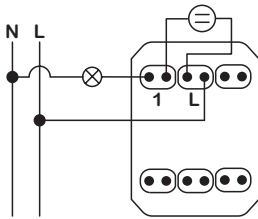

2 modules - One-way switch with location lamp

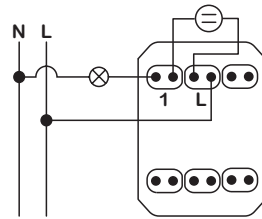

2 modules - Push-button with location lamp

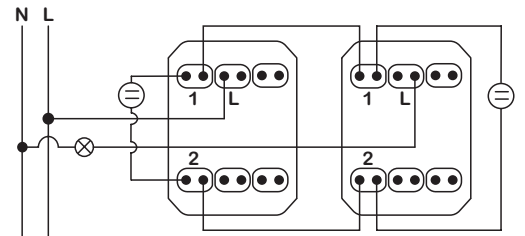

2 modules - Two way switch with location lamp

Room control

Room control unit and lamp & bell push-button

A: NU5217●● & B: NU5777●●

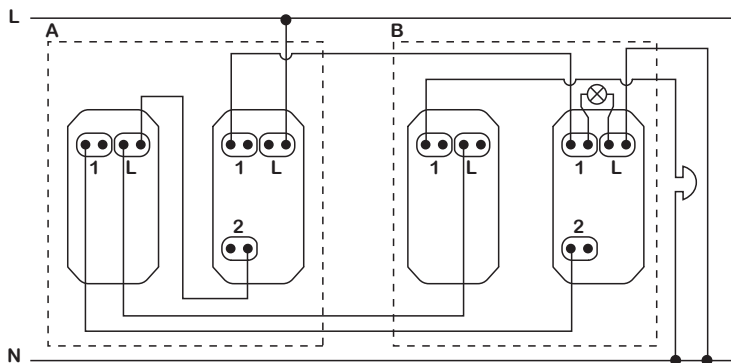

Control unit and lamp & bell push-button connection for room indication

Universal rotary dimmer LED

NU35141●●

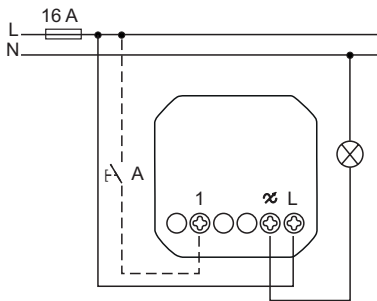

Controlling blinds locally

Motion sensor 10 A

NU3525●●

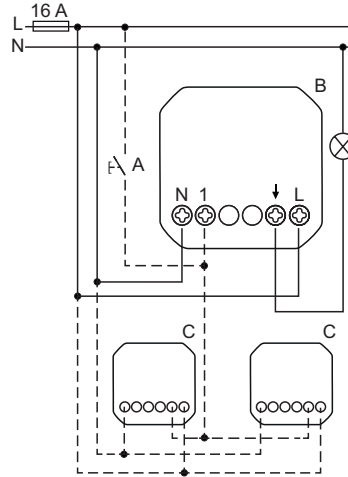

Detection moving heat sources
(e.g. persons)

Timer 10 A

NU3535●●

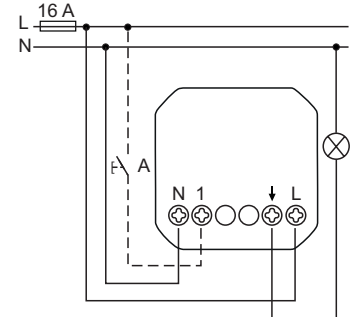

Manual switching off or restarting
the overtravel time with an activated
overtravel time

Floor thermostats 10 A

NU3503●●

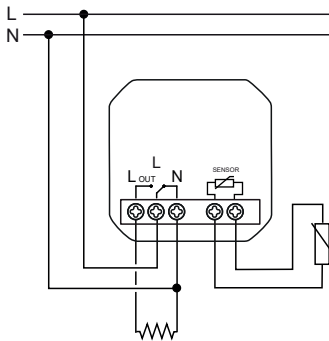

Room thermostats 8 A

NU3501●●

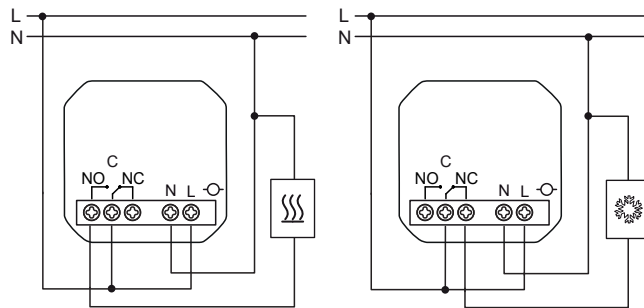

Electronic card switch 8 A

NU3540●●

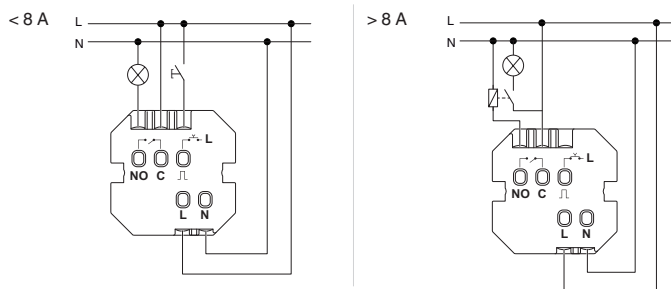

Multistandard socket outlet

NU3085●●
NU3084●●

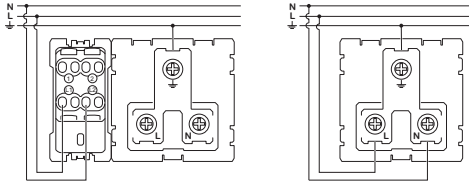

Plug compatibility table

	Standard	Plug type	Nominal voltage/ current
⇒ <input checked="" type="checkbox"/>			
1	Europlug	2P	250 V / 2,5 A
2	Argentinean / Australian	2P + E	250 V / 10 A
3	USA	2P + E	127 V / 15 A
4	British	2P + E	250 V / 13 A
5	Indian	2P + E	250 V / 6 A
6	Chinese	2P + E	250 V / 10 A



⚠ DANGER

The multistandard socket is not suitable for German and French 2P + E sockets as they do not provide ground continuity.

A residual current circuit protection with a sensitivity of 30 mA must be installed for this product.

Surge protected socket outlet

NU3059●●EP

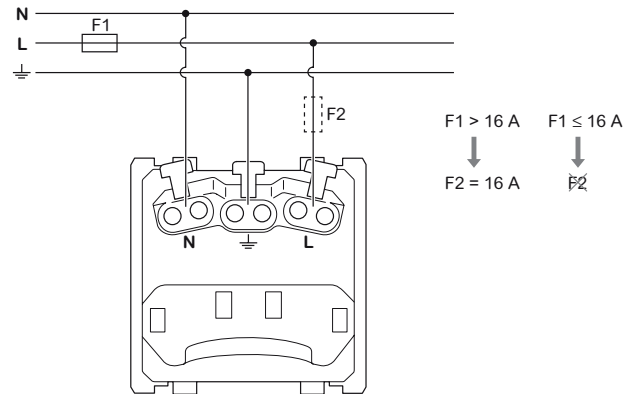
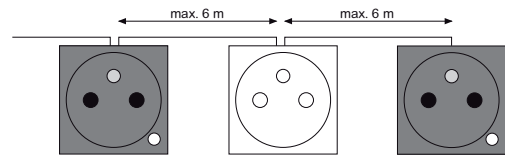
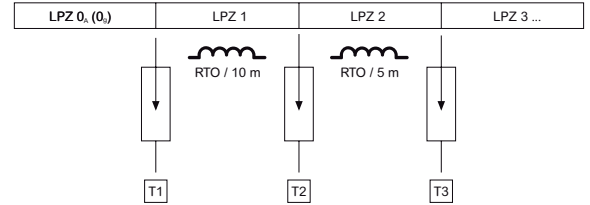

Wiser blind control switch

NU3508●●
NU3509●●

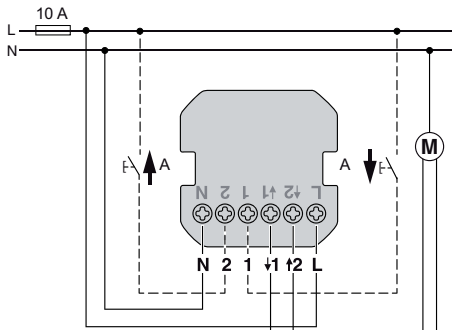

Wiser motion sensor 10 A

NU3526●●

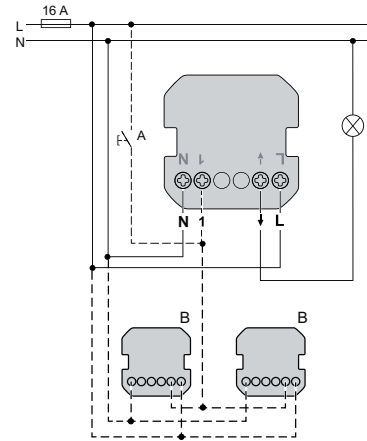

Wiser motion sensor with universal push-button dimmer LED

NU3527●●

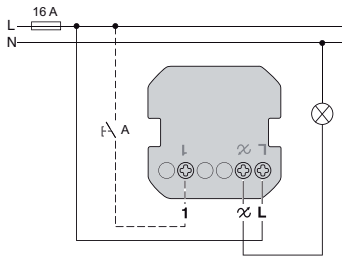

Wiser relay switch 10 A

NU3537●●
NU3538●●

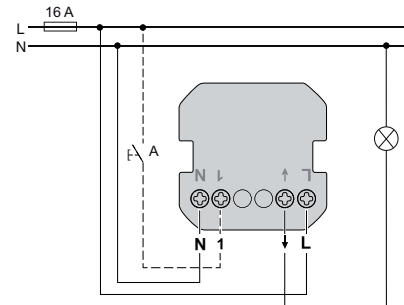

Wiser universal push-button dimmer LED

NU3515●●
NU3517●●

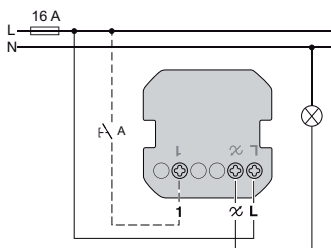

Wiser universal rotary dimmer LED

NU3516●●
NU3518●●

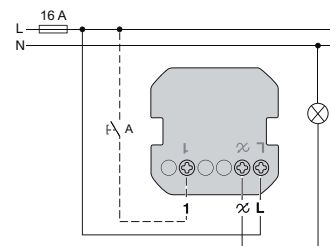





Connections

Data / Phone / TV

USB data connector

NU3429●●



1	Vbus (5V DC)	
2	D-	
3	D+	
4	GND	
5	\perp	

Unica

Connections

USB chargers

USB Chargers

Type A: **NU3428** (1 module) - **NU3418** (2 modules)

Type A + C : **NU3018** (2 modules)

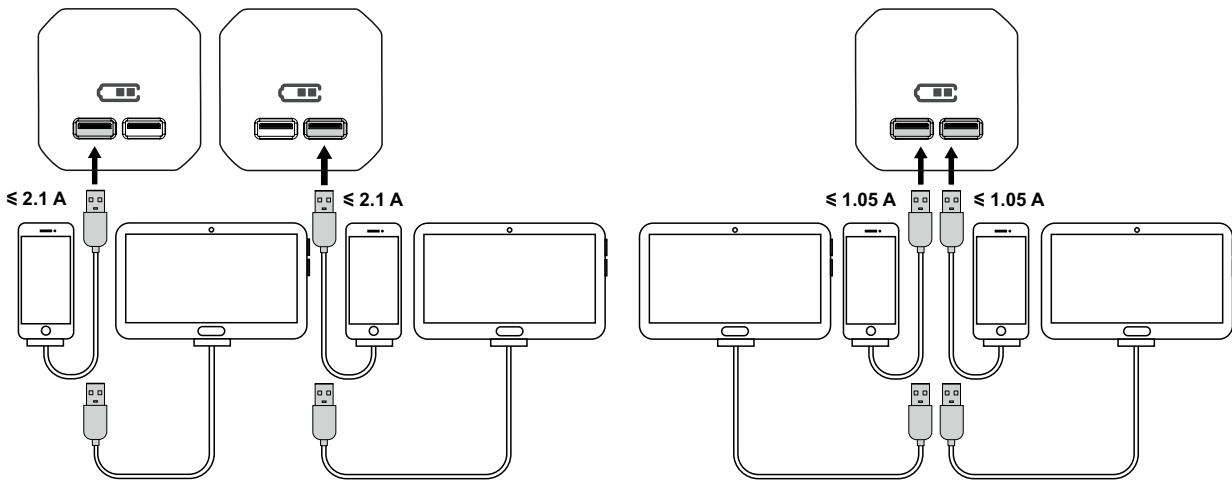
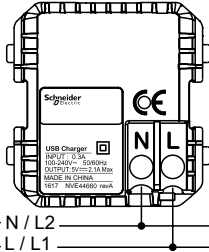

USB type A connection

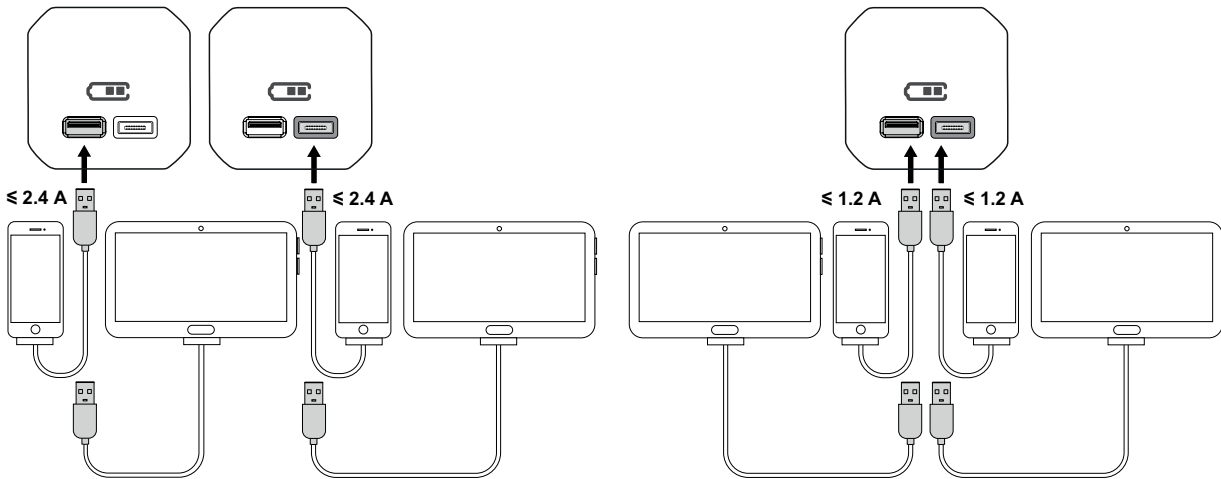

USB type A + C connection

Unica

Connections

Other functions

Bed side lamp

NU3603●●

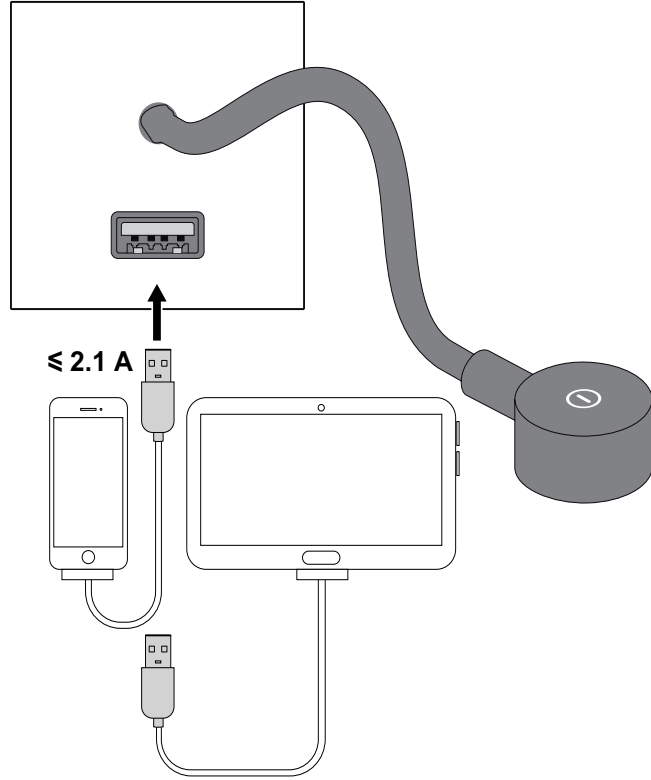
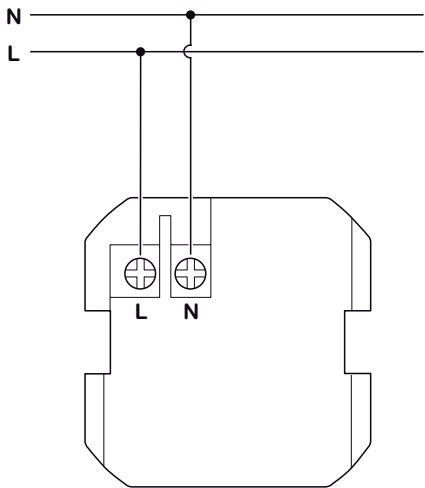
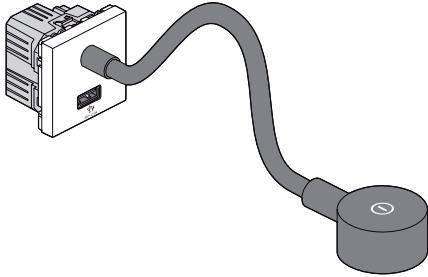

USB type A connection

Unica

Connections

Other functions

Electronic door bell

NU3786●●

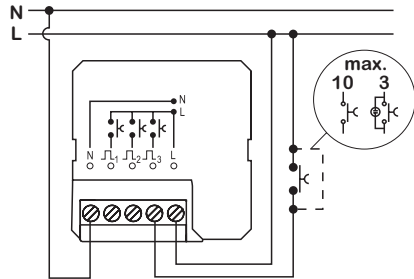

Manual switching off or restarting the overtravel time with an activated overtravel time

Volume control

NU3602●●

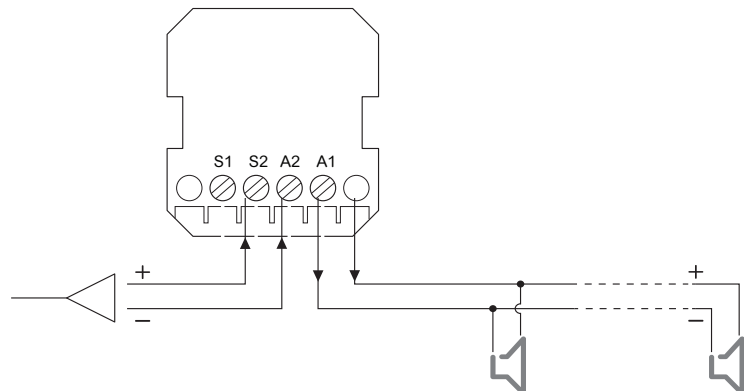

Bluetooth receiver

NU3601●●

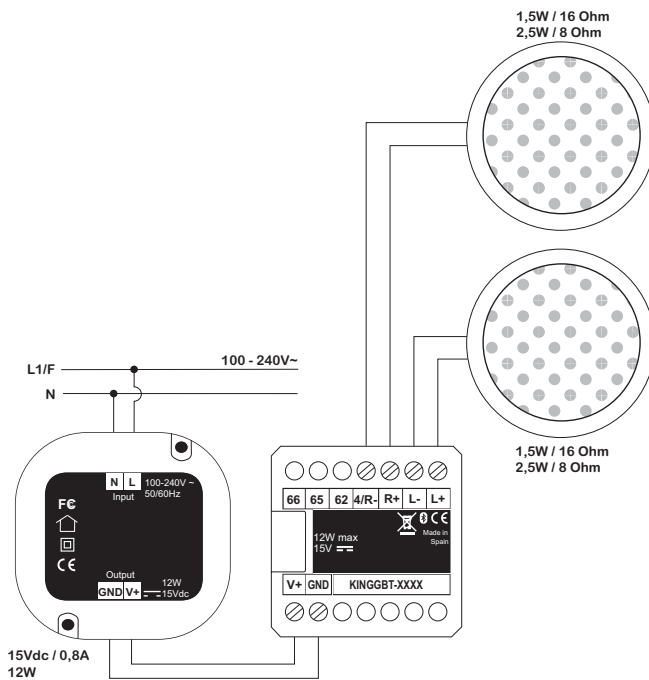

Unica

Connections

RJ45 data sockets

Installation

Example of unshielded punch down data socket installation

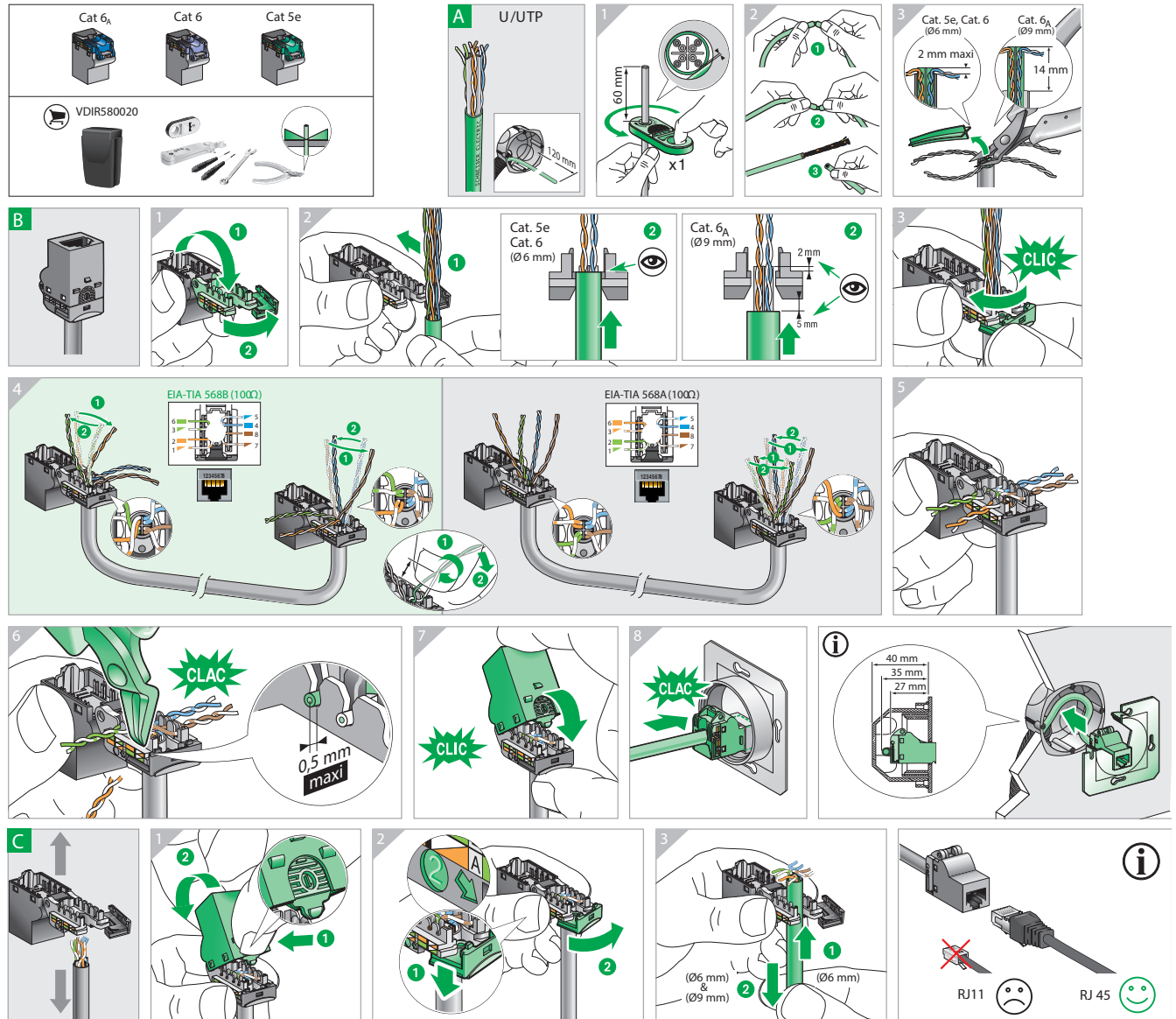

Technical data

Categories

- The most important property defining a data network is the speed at which information can circulate inside this network.
- According to this aspect, installations are classed into the following categories

Category	Transmission rate	Network type
Cat. 3	Up to 10 MHz	Ethernet 10 Base T, Token Ring 4 Mbps
Cat. 4	Up to 16 MHz	Token Ring 16 Mbps
Cat. 5 _e	Up to 100 MHz	Ethernet 1000 Base T, ATM 155 Mbps
Cat. 6	Up to 250 MHz	Ethernet 1000 Base T, ATM 1200
Cat. 6 _A	Up to 500 MHz	Ethernet full-duplex mode 1000 Base T

Connections

RJ45 data sockets

Installation

Example of unshielded punch down data socket installation

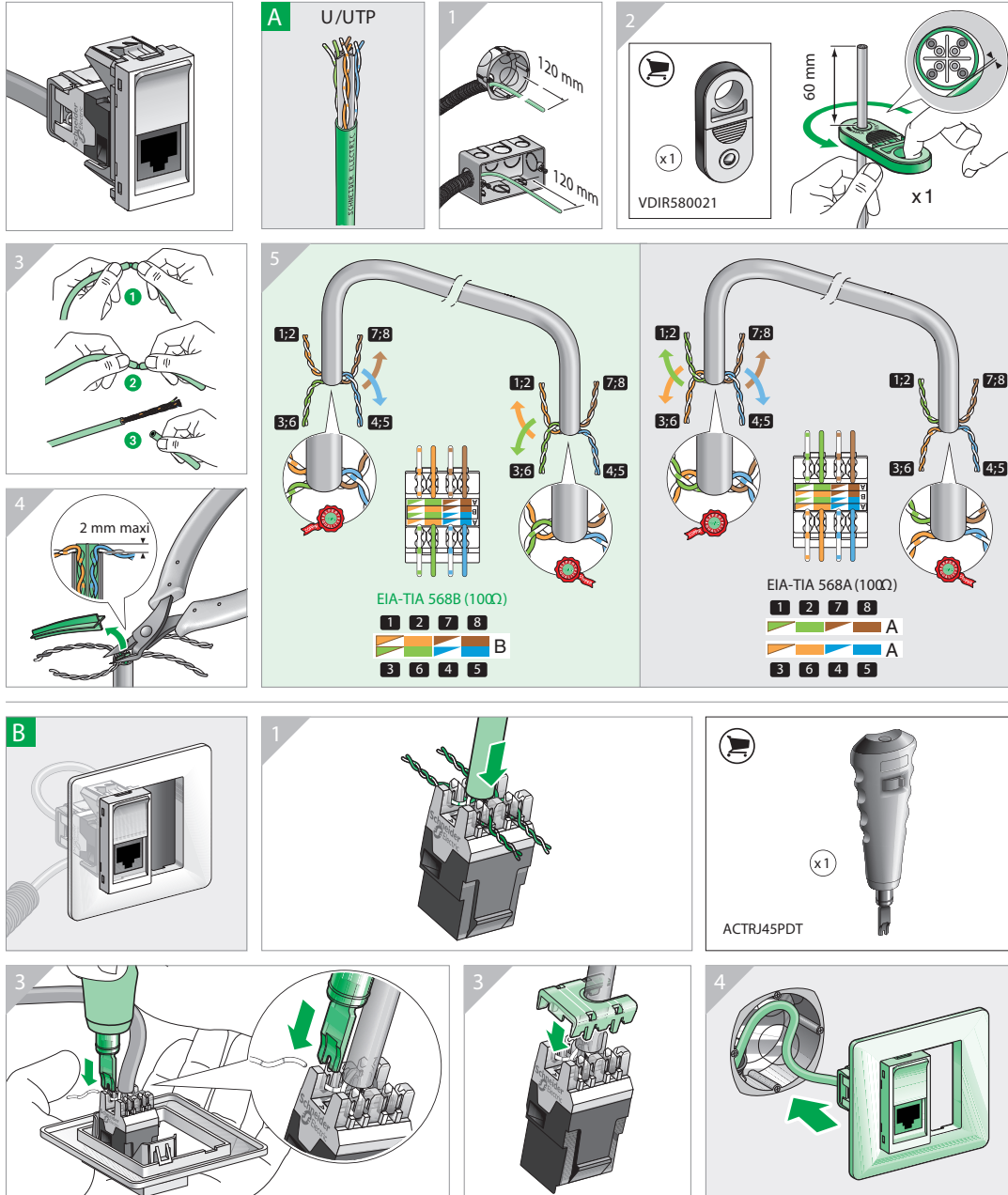

Unica Index

Reference number overview

Ref.	Pg.	Ref.	Pg.	Ref.	Pg.	Ref.	Pg.	Ref.	Pg.
A		NU6004V80	104	NU055318	106	NU200644	100	NU220644D	90
ALB45032	55	NU6004V82	104	NU055344	106	NU200654	100	NU221118D	90
ALB45033	55	NU6004V83	104	NU055418	106	NU200818	100	NU221130D	90
ALB45290	61	NU6004V84	104	NU055444	106	NU200830	100	NU221144D	90
C		NU6004V85	104	NU112118	138	NU200844	100	NU221154D	90
CCT90501	56, 75, 110, 113, 125, 130	NU6004V86	104	NU113118	138	NU200854	100	NU230001	103
I		NU6004V87	104	NU114118	138	NU201018	100	NU230013	103
IMT35914	96	NU6004V89	104	NU121020	133, 136	NU201030	100	NU230014	103
IMT35915	96	NU7002	94	NU121030	136	NU201044	100	NU230016	103
IMT35924	96	NU7002C	94	NU121054	136	NU201054	100	NU230018	103
IMT35934	96	NU7002G	94	NU121820	133, 136	NU203618D	91	NU230024	103
IMT35935	96	NU7002P	94	NU121830	136	NU203630D	91	NU230030	103
IMT35944	96	NU7002PC	94	NU121854	136	NU203644D	91	NU230031	103
IMT35945	96	NU7002PCP	94	NU122418	136	NU203654D	91	NU230044	103
IMT35994	96	NU7002PG	94	NU122420	133	NU203718	91	NU230054	103
IMT35995	96	NU7004PC	94	NU122430	136	NU206318	60	NU230218	103
M		NU7006C	94	NU122454	136	NU206344	60	NU230418	103
MGU5.064.18	61	NU7008C	94	NU123418	136	NU206518	60	NU230618	103
MGU5.064.30	61	NU7103	94	NU123420	133	NU206530	60	NU230818	103
MGU8.601	96	NU7103P	94	NU123430	136	NU206544	60	NU231018	103
MGU8.603	96	NU7104	94	NU123454	136	NU206554	60	NU270311	101
MGU8.604	96	NU7104P	94	NU124418	136	NU206718	58	NU270312	101
MT35925	96	NU7107	94	NU124420	133	NU206730	58	NU270313	101
MUR34101	106	NU7204P	139	NU124430	136	NU206744	58	NU270314	101
MUR34107	106	NU7404	94	NU124454	136	NU206754	58	NU270315	101
MUR34108	106	NU7802	95	NU171020	133, 136	NU210118	100	NU270316	101
MUR34109	106	NU7892	95	NU171030	136	NU210130	100	NU270317	101
MUR34151	106	NU8710	137	NU171054	136	NU210144	100	NU270318	101
MUR35110	106	NU8718	137	NU171820	133, 136	NU210154	100	NU270321	101
MUR37713	106	NU8724	138	NU171830	136	NU210218	100	NU270322	101
MUR37911	106	NU8734	138	NU171854	136	NU210230	100	NU270324	101
MUR37912	106	NU8744	138	NU172418	136	NU210244	100	NU270326	101
MUR37914	106	NU9091	61	NU172430	136	NU210254	100	NU270327	101
MUR39101	106	NU9092	61	NU172454	136	NU210318	100	NU270328	101
MUR39107	106	NU9580	95	NU173418	136	NU210330	100	NU270344	101
MUR39108	106	NU9800	139	NU173420	133	NU210344	100	NU270350M	102
MUR39109	106	NU9801	139	NU173430	136	NU210354	100	NU270351M	102
MUR39110	106	NU9802	139	NU173454	136	NU210418	100	NU270352M	102
MUR39151	106	NU9823AM	53, 73, 90, 123	NU174418	136	NU210430	100	NU270353M	102
MUR39911	106	NU9825A	53, 73, 90, 123	NU174430	136	NU210444	100	NU270355M	102
MUR39912	106	NU9825AZ	53, 73, 90, 123	NU174454	136	NU210454	100	NU270356M	102
MUR39913	106	NU9830	61	NU200118	106	NU210718	100	NU270357M	102
MUR39914	106	NU021020	133, 137	NU200130	106	NU210730	100	NU270358M	102
N		NU021030	137	NU200154	106	NU210744	100	NU270359M	102
NU3488	67	NU021054	137	NU200218	100	NU210754	100	NU270360M	102
NU003718	58, 91	NU021820	133, 137	NU200230	100	NU220118D	90	NU270362M	102
NU003744	58, 91	NU021830	137	NU200244	100	NU220130D	90	NU270411	101
NU3772	67	NU021854	137	NU200254	100	NU220144D	90	NU270412	101
NU3773	67	NU022418	138	NU200418	100	NU220154D	90	NU270413	101
NU3774	67	NU022418	138	NU200430	100	NU220318D	90	NU270414	101
NU3775	67	NU023418	138	NU200444	100	NU220330D	90	NU270415	101
NU3776	67	NU024418	138	NU200454	100	NU220344D	90	NU270416	101
		NU044218	106	NU200618	100	NU220354D	90	NU270417	101
				NU200630	100	NU220618D	90	NU270418	101

Reference number overview

Ref.	Pg.	Ref.	Pg.	Ref.	Pg.	Ref.	Pg.	Ref.	Pg.
NU270421	101	NU280224	101	NU280456M	102	NU280816	101	NU301854	62
NU270422	101	NU280226	101	NU280457	102	NU280817	101	NU301918	62
NU270424	101	NU280227	101	NU280457M	102	NU280818	101	NU301930	62
NU270426	101	NU280228	101	NU280458	102	NU280819	101	NU301944	62
NU270427	101	NU280244	101	NU280458M	102	NU280821	101	NU301954	62
NU270428	101	NU280250	102	NU280459	102	NU280822	101	NU302018	60
NU270444	101	NU280250M	102	NU280459M	102	NU280824	101	NU302044	60
NU270450M	102	NU280251	102	NU280460	102	NU280826	101	NU302118	60
NU270451M	102	NU280251M	102	NU280460M	102	NU280827	101	NU302130	60
NU270452M	102	NU280252	102	NU280462	102	NU280828	101	NU302144	60
NU270453M	102	NU280252M	102	NU280462M	102	NU280844	101	NU302154	60
NU270455M	102	NU280253	102	NU280611	101	NU280850	102	NU302318	60
NU270456M	102	NU280253M	102	NU280612	101	NU280850M	102	NU302330	60
NU270457M	102	NU280255	102	NU280613	101	NU280851	102	NU302344	60
NU270458M	102	NU280255M	102	NU280614	101	NU280851M	102	NU302354	60
NU270459M	102	NU280256	102	NU280615	101	NU280852	102	NU302818	60
NU270460M	102	NU280256M	102	NU280616	101	NU280852M	102	NU302830	60
NU270462M	102	NU280257	102	NU280617	101	NU280853	102	NU302854	60
NU270711	101	NU280257M	102	NU280618	101	NU280853M	102	NU303118	60
NU270712	101	NU280258	102	NU280619	101	NU280855	102	NU303130	60
NU270713	101	NU280258M	102	NU280621	101	NU280855M	102	NU303144	60
NU270714	101	NU280259	102	NU280622	101	NU280856	102	NU303154	60
NU270715	101	NU280259M	102	NU280624	101	NU280856M	102	NU303318	60
NU270716	101	NU280260	102	NU280626	101	NU280857	102	NU303330	60
NU270717	101	NU280260M	102	NU280627	101	NU280857M	102	NU303344	60
NU270718	101	NU280262	102	NU280628	101	NU280858	102	NU303354	60
NU270721	101	NU280262M	102	NU280644	101	NU280858M	102	NU303618	58
NU270722	101	NU280411	101	NU280650	102	NU280859	102	NU303644	58
NU270724	101	NU280412	101	NU280650M	102	NU280859M	102	NU303703	58
NU270726	101	NU280413	101	NU280651	102	NU280860	102	NU303706	58
NU270727	101	NU280414	101	NU280651M	102	NU280860M	102	NU303718	58
NU270728	101	NU280415	101	NU280652	102	NU280862	102	NU303718TA	58
NU270750M	102	NU280416	101	NU280652M	102	NU280862M	102	NU303720	127
NU270751M	102	NU280417	101	NU280653	102	NU281450	102	NU303730	58
NU270752M	102	NU280418	101	NU280653M	102	NU281452	102	NU303730TA	58
NU270753M	102	NU280419	101	NU280655	102	NU281453	102	NU303744	58
NU270755M	102	NU280421	101	NU280655M	102	NU281455	102	NU303744TA	58
NU270756M	102	NU280422	101	NU280656	102	NU281456	102	NU303754	58
NU270757M	102	NU280424	101	NU280656M	102	NU301518	59, 62	NU303754TA	58
NU270758M	102	NU280426	101	NU280657	102	NU301518E	62	NU303761	58
NU270759M	102	NU280427	101	NU280657M	102	NU301530	59, 62	NU303903E	59
NU270760M	102	NU280428	101	NU280658	102	NU301530E	62	NU303918	59
NU270762M	102	NU280444	101	NU280658M	102	NU301554	59, 62	NU303918E	59
NU280211	101	NU280450	102	NU280659	102	NU301554E	62	NU303930	59
NU280212	101	NU280450M	102	NU280659M	102	NU301618	62	NU303930E	59
NU280213	101	NU280451	102	NU280660	102	NU301630	62	NU303944E	59
NU280214	101	NU280451M	102	NU280660M	102	NU301644	62	NU303954	59
NU280215	101	NU280452	102	NU280662	102	NU301654	62	NU303954E	59
NU280216	101	NU280452M	102	NU280662M	102	NU301718	58, 62	NU304118	60
NU280217	101	NU280453	102	NU280811	101	NU301730	58, 62	NU304130	60
NU280218	101	NU280453M	102	NU280812	101	NU301744	58, 62	NU304154	60
NU280219	101	NU280455	102	NU280813	101	NU301754	58, 62	NU304518	60
NU280221	101	NU280455M	102	NU280814	101	NU301818	62	NU304530	60
NU280222	101	NU280456	102	NU280815	101	NU301830	62	NU304544	60

Reference number overview

Ref.	Pg.	Ref.	Pg.	Ref.	Pg.	Ref.	Pg.	Ref.	Pg.
NU304554	60	NU305954	59	NU307903T	69, 126	NU310618SC	51	NU320354	50
NU304703	61	NU305954E	59	NU307906	59, 126	NU310620	122	NU320354S	50
NU304718	61	NU305954EP	59	NU307918	59	NU310630	51	NU320354VMC	54
NU304730	61	NU305961	59	NU307918T	69	NU310630C	51	NU320518	50
NU304744	61	NU306018	60	NU307930	59	NU310630L	51	NU320520	122
NU304754	61	NU306030	60	NU307954	59	NU310630N	51	NU320530	50
NU304903	59, 126	NU306054	60	NU308418	61	NU310644	51	NU320544	50
NU304903T	69, 126	NU306103	59, 126	NU308430	61	NU310644CN	51	NU320554	50
NU304906	59, 126	NU306103S	59, 126	NU308454	61	NU310644N	51	NU320618	51
NU304918	59	NU306103T	69, 126	NU308518	61	NU310644NSC	51	NU320618C	51
NU304918T	69	NU306603	58	NU308818	61	NU310654	51	NU320618CN	51
NU304920	126	NU306618	58	NU308830	61	NU310654C	51	NU320618F	51
NU304930	59	NU306630	58	NU308918	61	NU310654L	51	NU320618FN	51
NU304954	59	NU306654	58	NU308930	61	NU310654N	51	NU320618L	51
NU305103	59, 126	NU306703	58	NU309818	61	NU310718SC	54	NU320618LN	51
NU305103T	69, 126	NU306703	58	NU309830	61	NU310730SC	54	NU320618N	51
NU305118	59	NU306703A	58	NU309918	61	NU310744SC	54	NU320620	122
NU305203	59, 126	NU306703AS	58	NU309930	61	NU310754SC	54	NU320620N	122
NU305203T	69, 126	NU306703S	58	NU310118	50	NU310818SC	54	NU320630	51
NU305206	59, 126	NU306703S	58	NU310118SC	50	NU310830SC	54	NU320630C	51
NU305218	59	NU306706AS	58	NU310118S-MUR	50	NU310844SC	54	NU320630CN	51
NU305218E	59	NU306718	58	NU310120	122	NU310854SC	54	NU320630L	51
NU305218P	59	NU306718A	58	NU310130	50	NU310918SC	54	NU320630LN	51
NU305218T	69	NU306718AS	58	NU310144	50	NU310944SC	54	NU320630N	51
NU305220	126	NU306718S	58	NU310144SC	50	NU312718SC	54	NU320644	51
NU305230	59	NU306720A	127	NU310154	50	NU312744SC	54	NU320644CN	51
NU305230E	59	NU306720AS	127	NU310318	50	NU313618	51	NU320644N	51
NU305244E	59	NU306730A	58	NU310318	50	NU313630	51	NU320654	51
NU305254	59	NU306730AS	58	NU310318F	50	NU313654	51	NU320654C	51
NU305254E	59	NU306754A	58	NU310318S	50	NU316118	52	NU320654CN	51
NU305703	58	NU306754AS	58	NU310318SC	50	NU316218	52	NU320654L	51
NU305706	58	NU306761AS	58	NU310318SD-ND	50	NU316218S	52	NU320654LN	51
NU305718	58	NU306818	60	NU310320	122	NU316318	52	NU320654N	51
NU305718	58	NU306903	59, 126	NU310330	50	NU316330	52	NU320718	54
NU305720	127	NU306903S	59, 126	NU310330S	50	NU316354	52	NU320730	54
NU305730	58	NU306903SE	59	NU310344	50	NU320118	50	NU320744	54
NU305744	58	NU306903T	69, 126	NU310344SC	50	NU320118SC	50	NU320754	54
NU305754	58	NU306906	59, 126	NU310354	50	NU320120	122	NU320818	54
NU305903	59, 126	NU306918	59	NU310354S	50	NU320130	50	NU320820	124
NU305903T	69, 126	NU306918S	59	NU310518	50	NU320144	50	NU320830	54
NU305906	59, 126	NU306918SE	59	NU310518SC	50	NU320144SC	50	NU320844	54
NU305918	59	NU306918T	69	NU310520	122	NU320154	50	NU320854	54
NU305918E	59	NU306930	59	NU310530	50	NU320318	50	NU321118	50
NU305918EP	59	NU306930S	59	NU310544	50	NU320318F	50	NU321130	50
NU305918P	59	NU306954	59	NU310554	50	NU320318P	50	NU321144	50
NU305920	126	NU306954S	59	NU310618	51	NU320318S	50	NU321154	50
NU305920T	69	NU307103	59, 126	NU310618C	51	NU320320	122	NU321318	50
NU305930	59	NU307103T	69, 126	NU310618CN	51	NU320320VMC	54, 124	NU321318F	50
NU305930E	59	NU307603	58	NU310618F	51	NU320330	50	NU321330	50
NU305930EP	59	NU307618	58	NU310618L	51	NU320330S	50	NU321344	50
NU305944E	59	NU307630	58	NU310618N	51	NU320330VMC	54	NU321354	50
NU305954	59	NU307903	59, 126	NU310618NSC	51	NU320344	50	NU321418	54

Reference number overview

Ref.	Pg.	Ref.	Pg.	Ref.	Pg.	Ref.	Pg.	Ref.	Pg.
NU321430	54	NU341444	63	NU344844	63	NU348644	67	NU351818	110
NU321454	54	NU341454	63	NU344854	63	NU348654	67	NU351830	110
NU322518	52	NU341518	63	NU344918	63	NU348718	67	NU351854	110
NU322620	54, 124	NU341530	63	NU344930	63	NU348730	67	NU352518	57
NU322630	54	NU341544	63	NU344944	63	NU348744	67	NU352530	57
NU322644	54	NU341554	63	NU344954	63	NU348754	67	NU352554	57
NU322654	54	NU341618	63	NU345018	66	NU349118	65	NU352618	111
NU323618	51	NU341630	63	NU345020	128	NU349130	65	NU352630	111
NU323630	51	NU341644	63	NU345030	66	NU349144	65	NU352644	111
NU323654	51	NU341654	63	NU345044	66	NU349154	65	NU352654	111
NU323718	54	NU341718	63	NU345054	66	NU349618	65	NU352718	111
NU323730	54	NU341730	63	NU345118	66	NU349630	65	NU352730	111
NU323754	54	NU341754	63	NU345130	66	NU349654	65	NU352744	111
NU324620	51, 122	NU341818	62	NU345144	66	NU349718	65	NU352754	111
NU324630	51	NU341830	62	NU345154	66	NU349730	65	NU353518	57
NU324654	51	NU341844	62	NU345218	66	NU349744	65	NU353530	57
NU326118	52	NU341854	62	NU345230	66	NU349754	65	NU353554	57
NU326218	52	NU341918	63	NU345254	66	NU349918	65	NU353718W	113
NU326218S	52	NU341918P	63	NU345318	66	NU349930	65	NU353720W	130
NU326230	52	NU341930	63	NU345330	66	NU349944	65	NU353730W	113
NU326230S	52	NU341954	63	NU345354	66	NU349954	65	NU353754W	113
NU326254	52	NU342018	63	NU345418	66	NU350118	56	NU353818	110
NU326254S	52	NU342030	63	NU345430	66	NU350130	56	NU353830	110
NU326318	52	NU342054	63	NU345444	66	NU350144	56	NU353854	110
NU326330	52	NU342618	63	NU345454	66	NU350154	56	NU354018	57
NU326354	52	NU342630	63	NU345518	66	NU350318	56	NU354030	57
NU328318	55	NU342654	63	NU345530	66	NU350330	56	NU354054	57
NU328330	55	NU342818	62	NU345554	66	NU350344	56	NU360118	67
NU328344	55	NU342830	62	NU345618	66	NU350354	56	NU360130	67
NU328354	55	NU342844	62	NU345630	66	NU350818W	113	NU360154	67
NU340618	63	NU342854	62	NU345654	66	NU350820W	130	NU360218	67
NU340630	63	NU342918	65	NU346118	66	NU350830W	113	NU360230	67
NU340654	63	NU342930	65	NU346120	128	NU350854W	113	NU360244	67
NU340718	63	NU342954	65	NU346130	66	NU350918	111	NU360254	67
NU340730	63	NU343018	65	NU346154	66	NU350930	111	NU360318	68
NU340754	63	NU343030	65	NU346218	66	NU350944	111	NU360330	68
NU341018	63	NU343044	65	NU346220	128	NU350954	111	NU360344	68
NU341030	63	NU343054	65	NU346230	66	NU351418	56	NU360354	68
NU341044	63	NU343118	65	NU346244	66	NU351420	125	NU360518	68
NU341054	63	NU343130	65	NU346254	66	NU351430	56	NU361218	68
NU341118	63	NU343154	65	NU346818	66	NU351454	56	NU363118	68
NU341130	63	NU343218	65	NU346830	66	NU351518W	113	NU363130	68
NU341144	63	NU343230	65	NU346844	66	NU351520W	130	NU363154	68
NU341154	63	NU343254	65	NU346854	66	NU351530W	113	NU370118	54
NU341218	63	NU343318	65	NU347818	63	NU351554W	113	NU373118	54
NU341230	63	NU343330	65	NU347918	63	NU351618W	113	NU373130	54
NU341244	63	NU343354	65	NU348218	63	NU351620W	130	NU373154	54
NU341318	63	NU344718	63	NU348318	63	NU351630W	113	NU378518	67
NU341330	63	NU344730	63	NU348418	63	NU351654W	113	NU378530	67
NU341344	63	NU344754	63	NU348518	63	NU351718	110	NU378544	67
NU341418	63	NU344818	63	NU348618	67	NU351730	110	NU378554	67
NU341430	63	NU344830	63	NU348630	67	NU351754	110	NU378618	67

Reference number overview

Ref.	Pg.	Ref.	Pg.	Ref.	Pg.	Ref.	Pg.	Ref.	Pg.
NU378630	67	NU501844	78	NU520654	72	NU528330	74	NU546118	79
NU378644	67	NU501854	78	NU520654N	72	NU528344	74	NU546130	79
NU378654	67	NU501918	78	NU520718	74	NU528354	74	NU546144	79
NU386218	68	NU501930	78	NU520730	74	NU541118	79	NU546154	79
NU386230	68	NU501944	78	NU520744	74	NU541118Z	87	NU546218	80, 87
NU386244	68	NU501954	78	NU520754	74	NU541130	79	NU546218Z	87
NU386254	68	NU503618Z	86	NU520818	74	NU541144	79	NU546230	80
NU400218	104	NU503644Z	86	NU520830	74	NU541144Z	87	NU546244	80, 87
NU400218	104	NU503718Z	86	NU520844	74	NU541154	79	NU546244Z	87
NU400218P	104	NU508218	58, 77	NU520854	74	NU541518	79	NU546254	80
NU400220	132	NU508230	58, 77	NU521118	72	NU541530	79	NU546318	80
NU400230	104	NU508244	58, 77	NU521118N	72	NU541544	79	NU546330	80
NU400254	104	NU508254	58, 77	NU521118NZ	84	NU541554	79	NU546344	80
NU400418	104	NU520118	72	NU521118Z	84	NU541818	78	NU546354	80
NU400420	132	NU520118N	72	NU521130	72	NU541830	78	NU546418	80
NU400430	104	NU520118NZ	84	NU521130N	72	NU541844	78	NU546430	80
NU400454	104	NU520118Z	84	NU521144	72	NU541854	78	NU546444	80
NU400618	104	NU520130	72	NU521144N	72	NU542018	79	NU546454	80
NU400620	132	NU520130N	72	NU521144Z	84	NU542030	79	NU548618	81
NU400630	104	NU520144	72	NU521154	72	NU542044	79	NU548630	81
NU400654	104	NU520144N	72	NU521154N	72	NU542054	79	NU548644	81
NU400818	104	NU520144Z	84	NU521318	72	NU542418	79	NU548654	81
NU400830	104	NU520154	72	NU521318N	72	NU542430	79	NU549218	79
NU400854	104	NU520154N	72	NU521330	72	NU542444	79	NU549230	79
NU406918	60	NU520318	72	NU521330N	72	NU542454	79	NU549244	79
NU406930	60	NU520318N	72	NU521344	72	NU542718	79	NU549254	79
NU406954	60	NU520318NZ	84	NU521344N	72	NU542730	79	NU550118	75
NU411018	104	NU520318Z	84	NU521354	72	NU542744	79	NU550130	75
NU411030	104	NU520330	72	NU521354N	72	NU542754	79	NU550144	75
NU411054	104	NU520330N	72	NU521518	72	NU543018	79	NU550154	75
NU411418	104	NU520344	72	NU521530	72	NU543030	79	NU550318	75
NU411420	132	NU520344N	72	NU521544	72	NU543044	79	NU550330	75
NU411430	104	NU520344Z	84	NU521554	72	NU543054	79	NU550344	75
NU411454	104	NU520354	72	NU521718	72	NU543118	79	NU550354	75
NU411618	104	NU520354N	72	NU521730	72	NU543130	79	NU550918	111
NU411620	132	NU520518	72	NU521744	72	NU543144	79	NU551418	75
NU411630	104	NU520518N	72	NU521754	72	NU543154	79	NU551430	75
NU411654	104	NU520518Z	84	NU522618	74	NU545418	80	NU551444	75
NU411818	104	NU520530	72	NU522644	74	NU545430	80	NU551454	75
NU411830	104	NU520530N	72	NU526218	73	NU545444	80	NU551718	110
NU411854	104	NU520544	72	NU526218S	73	NU545454	80	NU551730	110
NU501318	62, 78	NU520544N	72	NU526230	73	NU545518	80	NU551744	110
NU501330	62, 78	NU520554	72	NU526230S	73	NU545530	80	NU551754	110
NU501344	62	NU520554N	72	NU526244	73	NU545544	80	NU551818	110
NU501354	62, 78	NU520618	72, 90	NU526244S	73	NU545554	80	NU551830	110
NU501418	62, 78	NU520618N	72	NU526254	73	NU545618	80	NU551844	110
NU501430	62, 78	NU520618Z	84	NU526254S	73	NU545630	80	NU551854	110
NU501444	62	NU520630	72	NU528218	50, 72	NU545644	80	NU552518	76
NU501454	62, 78	NU520630N	72	NU528230	50, 72	NU545654	80	NU552530	76
NU501718	77, 78	NU520644	72, 90	NU528244	50, 72	NU545718	66	NU552544	76
NU501818	78	NU520644N	72	NU528254	50, 72	NU545730	66	NU552554	76
NU501830	78	NU520644Z	84	NU528318	74	NU545754	66	NU552618	111

Reference number overview

Ref.	Pg.	Ref.	Pg.	Ref.	Pg.	Ref.	Pg.	Ref.	Pg.
NU552718	111	NU600218	105	NU601018	105	NU910018N	53, 73, 85, 90	NU941030	64
NU553018	118	NU600224	105	NU601030	105			NU941044	64
NU553020	118, 131	NU600226	105	NU601054	105	NU910018U	53, 73, 85, 90	NU941054	64
NU553030	118	NU600230	105	NU610380	104	NU910020	123	NU941118	64
NU553054	118	NU600254	105	NU610382	104	NU910020N	123	NU941118T	69
NU553118	118	NU600280	104	NU610383	104	NU910030	53, 73, 85, 90	NU941120	128
NU553120	118, 131	NU600282	104	NU610384	104			NU941130	64
NU553130	118	NU600283	104	NU610385	104	NU910030N	53, 73, 85, 90	NU941144	64
NU553154	118	NU600284	104	NU610386	104	NU910030U	53, 73, 85, 90	NU941154	64
NU553518	76	NU600285	104	NU610387	104			NU942018	64
NU553530	76	NU600286	104	NU610389	104	NU910044	53, 73, 85, 90	NU942020	128
NU553544	76	NU600287	104	NU800218	96			NU942030	64
NU553554	76	NU600289	104	NU800244	96	NU910044N	53, 73, 85, 90	NU942054	64
NU553818	110	NU600418	105	NU800418	96	NU910044U	53, 73, 85, 90	NU942218	64
NU553830	110	NU600424	105	NU800444	96			NU942218*	64
NU553844	110	NU600426	105	NU800618	96	NU910054	53, 73, 85, 90	NU942230	64
NU553854	110	NU600430	105	NU800644	96	NU910054N	53, 73, 85, 90	NU942230*	64
NU555718	112	NU600454	105	NU810318	96			NU942254	64
NU555730	112	NU600480	104	NU810418	96	NU910054U	53, 73, 85, 90	NU942254*	64
NU555744	112	NU600482	104	NU821020	133, 137			NU942418	64
NU555754	112	NU600483	104	NU821030	137	NU920018	53, 73, 85, 90	NU942418*	64
NU555918	114	NU600484	104	NU821054	137			NU942430	64
NU555930	114	NU600485	104	NU821820	133, 137	NU920018N	53, 73, 85, 90	NU942430*	64
NU555954	114	NU600486	104	NU821830	137			NU942454	64
NU557118	112	NU600487	104	NU821854	137	NU920018U	53, 73, 85, 90	NU942454*	64
NU557118W	114	NU600489	104	NU822418	138	NU920020	123	NU943818	64
NU557120W	130	NU600618	105	NU823418	138	NU920020N	123	NU943830	64
NU557130	112	NU600624	105	NU824418	138			NU943854	64
NU557130W	114	NU600626	105	NU840218	96	NU920030	53, 73, 85, 90	NU943918	64
NU557144	112	NU600630	105	NU840230	96			NU943930	64
NU557154	112	NU600654	105	NU840254	96	NU920030N	53, 73, 85, 90	NU943954	64
NU557154W	114	NU600680	104	NU840418	96			NU944018	66, 80
NU577718	81	NU600682	104	NU840430	96	NU920044	53, 73, 85, 90	NU944030	66, 80
NU577730	81	NU600683	104	NU840454	96			NU944044	66, 80
NU577744	81	NU600684	104	NU840618	96	NU920044N	53, 73, 85, 90	NU944054	66, 80
NU577754	81	NU600685	104	NU840630	96			NU944118	66, 80
NU578618	81	NU600686	104	NU840654	96	NU920044U	53, 73, 85, 90	NU944120	128
NU578630	81	NU600687	104	NU903718	61, 77, 86			NU944130	66, 80
NU578644	81	NU600689	104			NU920054N	53, 73, 85, 90	NU944154	66, 80
NU578654	81	NU600818	105	NU903718U	61, 77, 86			NU946018	64
NU586218	81	NU600824	105	NU903730	61, 77, 86	NU920054U	53, 73, 85, 90	NU946020	128
NU586230	81	NU600826	105					NU946030	64
NU586244	81	NU600830	105	NU903730U	61, 77, 86	NU940618	64	NU946044	64
NU586254	81	NU600854	105			NU940620	128	NU946054	64
NU586618	81	NU600880	104	NU903744	61, 77, 86	NU940630	64	NU946118	64
NU586630	81	NU600882	104			NU940654	64	NU946120	128
NU586644	81	NU600883	104	NU903744U	61, 77, 86	NU940718	64	NU946130	64
NU586654	81	NU600884	104			NU940720	128	NU946144	64
NU593218	79	NU600885	104	NU903754	61, 77, 86	NU940730	64	NU946154	64
NU593230	79	NU600886	104			NU940754	64	NU946218	64
NU593244	79	NU600887	104	NU903754U	61, 77, 86	NU941018	64	NU946220	128
NU593254	79	NU600889	104	NU910018	53, 73, 85, 90	NU941020	128	NU946230	64

Reference number overview

Ref.	Pg.
NU946254	64
NU946318	64
NU946320	128
NU946330	64
NU946354	64
NU946418	64
NU946430	64
NU946454	64
NU947818	64
NU947830	64
NU947854	64
NU947918	64
NU947930	64
NU947954	64
NU986418	68
NU986430	68
NU986444	68
NU986454	68
NU986518	68
NU986520	129
NU986530	68
NU986544	68
NU986554	68
NU986618	68
NU986620	129
NU986630	68
NU986644	68
NU986654	68
S	
S520299	53, 73, 85, 90, 123
U	
U0.582	95
U22.805	139



Green Premium™

Endorsing eco-friendly products in the industry



Green Premium™

Product

Green Premium is the only label that allows you to effectively develop and promote an environmental policy whilst preserving your business efficiency. This ecolabel guarantees compliance with up-to-date environmental regulations, but it does more than this.

Over 75% of Schneider Electric manufactured products have been awarded the Green Premium ecolabel



Discover what we mean by green ...

Check your products!

Schneider Electric's Green Premium ecolabel is committed to offering transparency, by disclosing extensive and reliable information related to the environmental impact of its products:

RoHS

Schneider Electric products are subject to RoHS requirements at a worldwide level, even for the many products that are not required to comply with the terms of the regulation. Compliance certificates are available for products that fulfil the criteria of this European initiative, which aims to eliminate hazardous substances.

REACH

Schneider Electric applies the strict REACH regulation on its products at a worldwide level, and discloses extensive information concerning the presence of SVHC (Substances of Very High Concern) in all of its products.

PEP: Product Environmental Profile

Schneider Electric publishes complete set of environmental data, including carbon footprint and energy consumption data for each of the lifecycle phases on all of its products, in compliance with the ISO 14025 PEP ecopassport program. PEP is especially useful for monitoring, controlling, saving energy, and/or reducing carbon emissions.

EoLI: End of Life Instructions

Available at the click of a button, these instructions provide:

- Recyclability rates for Schneider Electric products.
- Guidance to mitigate personnel hazards during the dismantling of products and before recycling operations.
- Parts identification for recycling or for selective treatment, to mitigate environmental hazards/ incompatibility with standard recycling processes.

Life Is On



Schneider Electric Industries SAS

35, rue Joseph Monier
CS 30323
92506 Rueil Malmaison Cedex
France

RCS Nanterre 954 503 439
Capital social 928 298 512 €
www.se.com

01-2023

© 2023 - Schneider Electric. All Rights Reserved.
All trademarks are owned by Schneider Electric Industries SAS or its affiliated companies.
Document reference:LSB03605EN

This document has been
printed on recycled paper

